



User Guide

Modular Heating System MHS Induction Generator

E 851 GB

25.05.2022

Table of Contents

1	Preface	4
1.1	Legal Notice.....	4
1.1.1	Version Details	4
1.2	About this Manual	4
1.2.1	Limitation of Liability	4
1.2.2	Terms of Delivery	4
1.2.3	Copyright	5
1.2.4	Warranty.....	5
1.3	Reliability, Safety	6
1.3.1	Applicability	6
1.3.2	Target Group of the Instruction Manual	6
1.3.3	Intended Use	6
1.3.4	Reliability	6
1.3.5	Hazard and Other Warnings	7
1.3.6	Other Notices	7
1.3.7	Signs	8
1.3.8	Safety	8
1.3.9	IT Security	9
1.3.10	Hazards caused by electromagnetic fields (EMFV)	9
1.3.11	Electromagnetic Compatibility.....	9
2	Product Description	12
2.1	General Description.....	12
2.2	MHS Induction Generator.....	12
2.3	Induction Coils	13
2.4	System View	14
2.5	Application	15
2.5.1	Intended Use	15
2.5.2	Foreseeable Misuse	15
2.6	Technical Data.....	17
2.6.1	General MHS Induction Generator Specifications	17
2.6.2	Dimensions.....	18
3	Construction and Functionality	19
3.1	Brief Description	19
3.2	Contents of Package	22
3.3	Transport and Storage.....	22
3.4	Control Unit Layout.....	24
3.4.1	Power Supply (X100)	25
3.4.2	Connecting the Induction Coils (X150), (X151).....	26
3.4.3	Module Bus (X25)	26
3.4.4	PE Conductor.....	27
3.4.5	Indicators and Controls	27
4	Installation and Putting into Service	28
4.1	Mechanical Installation	28
4.1.1	Preparatory Steps	30
4.1.2	Mounting Position.....	30
4.1.3	Free Ambient Space	31
4.1.4	Fastening Bores	31
4.1.5	Connecting two Power Modules.....	31

4.2	Electrical Installation.....	32
4.2.1	General.....	32
4.2.2	Line Interfacing.....	32
4.2.3	Electrical Connection	33
4.2.4	Power supply fusing	34
4.3	Configuration	37
4.3.1	Module Bus Addresses	37
4.3.2	Installing the Software.....	37
4.3.3	Address Setup.....	37
4.4	Putting into Service.....	38
4.4.1	General Notes	38
4.4.2	Start-up Prerequisites	38
4.5	Operating Functions	39
4.5.1	State Machine	39
4.5.2	Finding the Resonance Frequency.....	40
4.5.3	Frequency Adjustment	40
4.5.4	Short Circuit Detection	41
4.5.5	Measuring the Capacity and Current	41
4.5.6	DC Link Monitoring.....	42
4.5.7	24 VDC Power Supply Monitoring.....	42
4.5.8	Heat Sink Temperature Monitoring	42
4.5.9	Watchdog Monitoring	43
4.5.10	Handshake	43
4.5.11	CAN Module Bus Monitoring.....	43
4.6	Diagnosis	44
4.6.1	General.....	44
4.6.2	Generator Module Messages:.....	44
4.6.3	Table of Faults.....	45
5	Operation.....	47
6	Maintenance / Servicing / Repairs.....	48
6.1	General	48
6.2	Preventive Maintenance	48
6.3	Repairs / Customer Service.....	48
6.4	Warranty	48
7	Taking out of Service / Uninstalling / Disposal	49
8	Programming.....	50
9	Appendix.....	51
9.1	Insulation	51
9.2	Dimensions	52
9.2.1	Housing Dimensions	52
9.2.2	Mounting Dimensions.....	53
9.3	Certificates.....	54
9.4	Order Specifications	54
9.4.1	Accessories	54
9.5	Sales & Service	54
9.5.1	Malente Headquarters.....	55

1 Preface

1.1 Legal Notice

Contact Details

Kendrion Kuhnke Automation GmbH
 Industrial Control Systems
 Lütjenburger Str. 101
 D-23714 Malente
 Germany

Support (phone) +49 4523 402-300
 Support (email) controltechnology-ics@kendrion.com
 Switchboard +49 4523 402-0
 Sales (email) sales-ics@kendrion.com
 Internet www.kendrion.com

1.1.1 Version Details

Modification History	
Date	Comments / Modifications
24.05.2019	Preliminary version
11.05.2020	Installation and operation safety instructions, more fieldbus systems Corrected and extended
18.08.2020	Section 4.5.2 Finding the Resonance Frequency. Display of separate frequencies added
17.08.2021	IT Security
25.05.2022	Update

1.2 About this Manual

This technical information is primarily directed to system designers, project engineers and device developers. It does not contain any availability information. We reserve the rights for errors, omissions and modifications. Pictures are similar.

1.2.1 Limitation of Liability

Specifications are for description only and are not to be understood as guaranteed product properties in a legal sense. Exact properties and characteristics shall be agreed in the specific contract. Claims for damages against us - on whatever grounds - are excluded, except in instances of deliberate intent or gross negligence on our part.

1.2.2 Terms of Delivery

The general conditions of sales and service of Kendrion Kuhnke Automation GmbH shall apply.

1.2.3 Copyright

© Kendrion Kuhnke Automation GmbH

This instruction manual is proprietary and protected by copyright.

No part of this document may be reproduced or copied in any way or by any means except expressly permitted in writing by Kendrion Kuhnke Automation GmbH.

Microsoft®, Windows® and the Windows® logo are registered trademarks of Microsoft Corp. in the USA and other countries. EtherCAT® is a registered trademark and patented technology, licenced by Beckhoff Automation GmbH, Germany. Further information about the PLCopen organisation is available at www.plcopen.org. CiA® and CANopen® are registered joint brands of CAN in Automation e.V. Title to all companies and company names mentioned herein as well as to products and product names is held by the respective enterprises.

CODESYS V3® is a product of 3S-Smart Software GmbH.

1.2.4 Warranty

Warranty is subject to the provisions of the conditions of sale of Kendrion Kuhnke Automation GmbH or any contractual agreements between the parties.

1.3 Reliability, Safety

1.3.1 Applicability

For reasons of personal safety and to avoid material damages when working with or handling this Kendrion Kuhnke product, you are advised to take heed of the notes and information contained in this instruction manual.

1.3.2 Target Group of the Instruction Manual

This instruction manual contains all information necessary for the use of the described product (control unit, control terminal, software, etc.) according to instructions. It is written for design, project planning, servicing and commissioning experts. For proper understanding and error-free application of technical descriptions, instructions for use and particularly of notes of danger and warning, extensive knowledge of automation technology is compulsory.

1.3.3 Intended Use

Kendrion Kuhnke's products are designed, developed and manufactured for standard industrial use. They must not be used for any other purposes than the ones specified in the catalogue or the associated technical documentation. Proper and safe operation depends on the products being transported, stored, lined up, mounted, installed, put into service, operated, and serviced correctly. Ambient conditions must be within the admissible limits. Notes and information in the associated documentation apply at all times.

1.3.4 Reliability

Reliability of Kendrion Kuhnke products is brought to the highest possible standards by extensive and cost-effective means in their design and manufacture.

These include:

- selecting high-quality components,
- quality agreements with our suppliers,
- actions to avoid static charges when handling MOS circuits,
- worst case planning and design of all circuits,
- visual inspections at various stages of fabrication,
- computer-aided tests of all assemblies and their interaction in the circuit,
- statistical assessment of the quality of fabrication and of all returned goods for the immediate taking of appropriate corrective actions.

1.3.5 Hazard and Other Warnings

Despite the actions described in section 1.3 Reliability, Safety, the occurrence of faults or errors in electronic control units - even if most highly improbable - must be taken into consideration.

Please pay particular attention to the additional notices which we have marked by symbols throughout this instruction manual. While some of these notices make you aware of possible dangers, others are intended as a means of orientation. They are described further down below in descending order of importance.

Every alert and hazard warning is made up as follows:

Type and source of risk

Potential consequences of non-observance

⇒ Preventive measures



	DANGER
	<i>A DANGER warning makes you aware of an immediately hazardous situation which WILL cause a serious or fatal accident if not observed.</i>
	WARNING
	<i>A WARNING makes you aware of a potentially hazardous situation which MAY cause a serious or fatal accident or damage to this or other devices if not observed.</i>
	CAUTION
	<i>A CAUTION alert makes you aware of a potentially hazardous situation which MAY cause an accident or damage to this or other devices if not observed.</i>
	NOTE
	<i>A NOTE makes you aware of a potentially hazardous situation which MAY cause damage to this or other devices if not observed.</i>

1.3.6 Other Notices

	Information
	<i>This symbol draws your attention to additional information concerning the use of the described product. This may include cross references to information found elsewhere (e.g. in other manuals).</i>

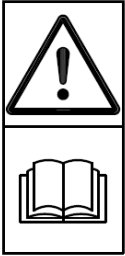

1.3.7 Signs

Signs used throughout the manual and on the unit are intended to make you aware of hazards or to provide useful information. For the most part, the signs are self-explanatory, but look for further details in this manual.

	General warning sign
	Warning, electric shock hazard
	Warning, hot surface
	Note, refer to the manual

1.3.8 Safety

Our products normally become part of larger systems or installations. The installer is responsible for the safety of the system that the unit will become a part of. The notes below should help you install the product in its working environment without producing any hazards for humans or the machine/system.

	DANGER
	<p>Non-observance of the instruction manual</p> <p><i>Measures for the prevention of dangerous faults or errors may be rendered ineffective or new hazard sources created.</i></p> <ul style="list-style-type: none"> ⇒ <i>Thoroughly read the instruction manual</i> ⇒ <i>Take particular heed of the hazard warnings</i>
	<p>Information</p> <p><i>To achieve a high degree of conceptual safety in planning and installing an electronic controller, it is essential to exactly follow the instructions given in the manual because wrong handling could lead to rendering measures against dangers ineffective or to creating additional dangers.</i></p>

Project Planning

- 24 V DC/AC power supply: generate as electrically safely separated low voltage. Suitable devices include split-winding transformers built in compliance with European Standard EN 60742 (corresponds to VDE 0551).
- Power breakdowns or power fades: the program structure is to ensure that a defined state at restart excludes all dangerous states.

- Emergency-off installations must comply with EN 60204/IEC 204 (VDE 0113). They must be operative at any time.
- Safety and precautions regulations for qualified applications have to be complied with.
- Please pay particular attention to the notices of warning which, at relevant places, will make you aware of possible sources of dangerous mistakes or faults.
- Relevant standards and VDE regulations are to be complied with in every case.
- Control elements are to be installed in such a way as to exclude unintended operation.
- Lay control cables such that interference (inductive or capacitive) is excluded if this interference could influence controller operation or its functionality.

Maintenance and Servicing

- Precautions regulation BGV A3 (Elektrische Anlagen und Betriebsmittel) to be observed when measuring or checking a controller after power-up. This applies to section 8 (Admissible deviations when working on parts) in particular.
- Spare parts: Only use parts approved of by Kuhnke. Only genuine Kuhnke modules must be used in modular controllers.
- Modular systems: always plug or unplug modules in a power-down state. You may otherwise damage the modules or (possibly not immediately recognisably!) inhibit their functionality.
- Always dispose of (rechargeable) batteries as hazardous waste.

1.3.9 IT Security

Kendrion Kuhnke products are designed for use in closed (private) industrial network environments.

In case such industrial networks are open to public access (e.g. via fully accessible network interfaces) or otherwise externally accessible (e.g. via data links and public (Internet) traffic), the integrator and operator must take appropriate organisational and technical precautions to protect the in-house network and ensure IT security.

	Information
<i>To find information about how to safely operate equipment, systems and networks, please refer to the texts published by BSI (Federal Office for Information Security), other publicly available sources and IEC 62443.</i>	

1.3.10 Hazards caused by electromagnetic fields (German Ordinance on the Safe Handling of Electromagnetic Fields – EMFV)

The biological effects that electric, magnetic and electromagnetic fields may have on the human body vary depending on their frequency, modulation and intensity. Effects that electromagnetic fields have been shown to have on humans up to the level of health damage include short-term effects such as sensory organ, nerve and muscle irritation (non-thermal effects) of static and low-frequency fields (0 to 100 kHz) and heat effects of high-frequency fields (100 kHz to 300 GHz) provoked by the body tissue absorbing radiation energy.

System operators must go by the EMFV to assess the hazards potentially caused by electromagnetic fields and to limit or label the working area based on the assessment results and the applicable standards.

1.3.11 Electromagnetic Compatibility

Definition

Electromagnetic compatibility is the ability of a device to function satisfactorily in its electromagnetic environment without itself causing any electromagnetic interference that would be intolerable to other devices in this environment.

Of all known phenomena of electromagnetic noise, only a certain range occurs at the location of a given device. It is defined in the relevant product standards.

The design and immunity to interference of industrial induction heaters are internationally governed by standard EN 61326-1 Electrical equipment for measurement, control and laboratory use – EMC requirements

	Information
	<i>Refer to IEC 61131-4, User's Guideline, for general installation instructions to be complied with to ensure that hardware interface factors and the ensuing noise voltages are limited to tolerable levels.</i>

Interfering Emission

Interfering emission of electromagnetic fields, HF
compliant to EN 55011, limiting value class A, Group 1 at operating frequencies < 9 kHz, otherwise Group 2

	Information
	<i>If the controller is designed for use in residential areas, high-frequency emissions must comply with limiting value class B as described in EN 55011. Fitting the controller into earthed metal cabinets and installing filters in the supply lines may produce a shielding compliant to the above standard.</i>

	Information
	<i>Fitting the controller into earthed metal cabinets and installing filters in the supply lines may produce a shielding compliant to interference emission standard EN 55011, limiting value class A.</i>

General Notes on Installation

As component parts of machines, facilities and systems, electronic control systems must comply with valid rules and regulations, depending on their field of application.

General requirements concerning the electrical equipment of machines and aiming at the safety of these machines are contained in Part 1 of European Standard EN 60204 (same as VDE 0113).

Electrical Immission Safeguard

To eliminate electromagnetic interference, connect the control system to the protective earth conductor. Practice best cable routing.

Cable Routing and Wiring

Keep power circuits separate from control circuits:

- DC voltages 60 V ... 400 V
- AC voltages 25 V ... 400 V

Joint laying of control circuits is allowed for:

- shielded data signals
- shielded analogue signals
- unshielded digital I/O lines
- unshielded DC voltages < 60 V
- unshielded AC voltages < 25 V

Location of Installation

Ensure that temperatures, contaminations, impact, vibration or electromagnetic interference are no impediment to the installation.

Temperature

Consider heat sources such as general heating of rooms, sunlight, heat accumulation in assembly rooms or control cabinets.

Contamination

Use suitable casings to avoid possible negative influences due to humidity, corrosive gas, liquid or conducting dust.

Impact and Vibration

Consider possible influences caused by motors, compressors, transfer lines, presses, ramming machines and vehicles.

Electromagnetic Interference

Consider electromagnetic interference from various local sources: motors, switching devices, switching thyristors, radio-controlled devices, welding equipment, arcing, switched-mode power supplies, converters / inverters.

Particular Sources of Interference

Inductive Actuators

Switching off inductances (such as from relays, contactors, solenoids or switching magnets) produces surge voltages. It is necessary to reduce these extra voltages to a minimum.

Reducing elements may be diodes, Z-diodes, varistors or RC elements. Their rating should conform to the specifications provided by the manufacturer or supplier of the actuators.

2 Product Description

2.1 General Description

The induction heating technology uses the eddy current losses to quickly and directly heat metallic materials. Heat is available rapidly and is induced into the material fairly evenly.

Benefits include:

- rapid heating and cooling
- highly dynamic control response
- energy efficiency

Kendrion's unitised inductive heating system

2.2 MHS Induction Generator

The MHS induction generator is designed to feed induction coils (inductors).

The unit operates on the three-phase current mains at voltages of up to 400 V and a frequency of 50/60 Hz. It rectifies the mains current and outputs it to the intermediate circuit used to separately feed power to each of the inductors.

The MHS Controller of the modular and stackable industrial heating system provides the actuation and fieldbus connection. Every channel can be separately set between 0% and 100%.

The latest semiconductor switches make the output stages work extremely efficiently at operating frequencies of up to 25 kHz.

Properties

- Max. 6 separately actuated channels (depending on product variant)
- Independent control of up to 6 induction coils (depending on product variant)
- Industry-ready and sturdy design
- Max. 26 kW continuous power (depending on product var
- Operating point optimised for low power loss
- Compact design



2.3 Induction Coils

The induction coils – or inductors for short – operate in an RLC series circuit together with the induction generator's capacitors.

Their capacitors vary with the device variant.

By design, all inductors must meet the induction generators' parameter settings.

Key parameters include:

Switching frequency:	max. 25 kHz
Output current:	max. 27 Aeff
Peak voltage (Up):	max. 1000 V

A short-circuit-proof output stage supplies the coil.

	CAUTION
	<p>High voltages at the inductors' terminals.</p> <p><i>The inductors operate as a resonant circuit. Resonant circuits may carry high voltages. The units are rated at max. 1,000 VAC at the inductors' terminals.</i></p> <ul style="list-style-type: none"> ⇒ <i>None of the inductor ratings must exceed a voltage of 1,000 VAC across the inductor.</i> ⇒ <i>If in doubt, please contact Kendrion Kuhnke Automation GmbH.</i>

	NOTE
	<p>The inductors are a key component of the inductive heating system.</p> <p><i>Kendrion recommends using inductors supply by Kendrion because they accurately adapt to the conditions of both the application and the generators of choice.</i></p>

	NOTE
	<p>To indirectly heat up the workpieces in service, the inductors generate magnetic fields with frequencies in the kilohertz range. The magnetic field strength in the immediate vicinity depends on the application.</p> <p><i>The Occupational Health and Safety Act also applies to the magnetic fields at the place of work. There are various and possibly mandatory directives on the measuring and assessment methods.</i></p>

	NOTE
	<p>In service, the inductors and generators will produce noise and vibrations.</p> <p><i>Consider these immissions when assessing the working conditions. To analyse the hazards, operators are advised to measure and/or calculate the sound pressure both at the exact location of use and 1 m away from the device enclosure.</i></p>

2.4 System View

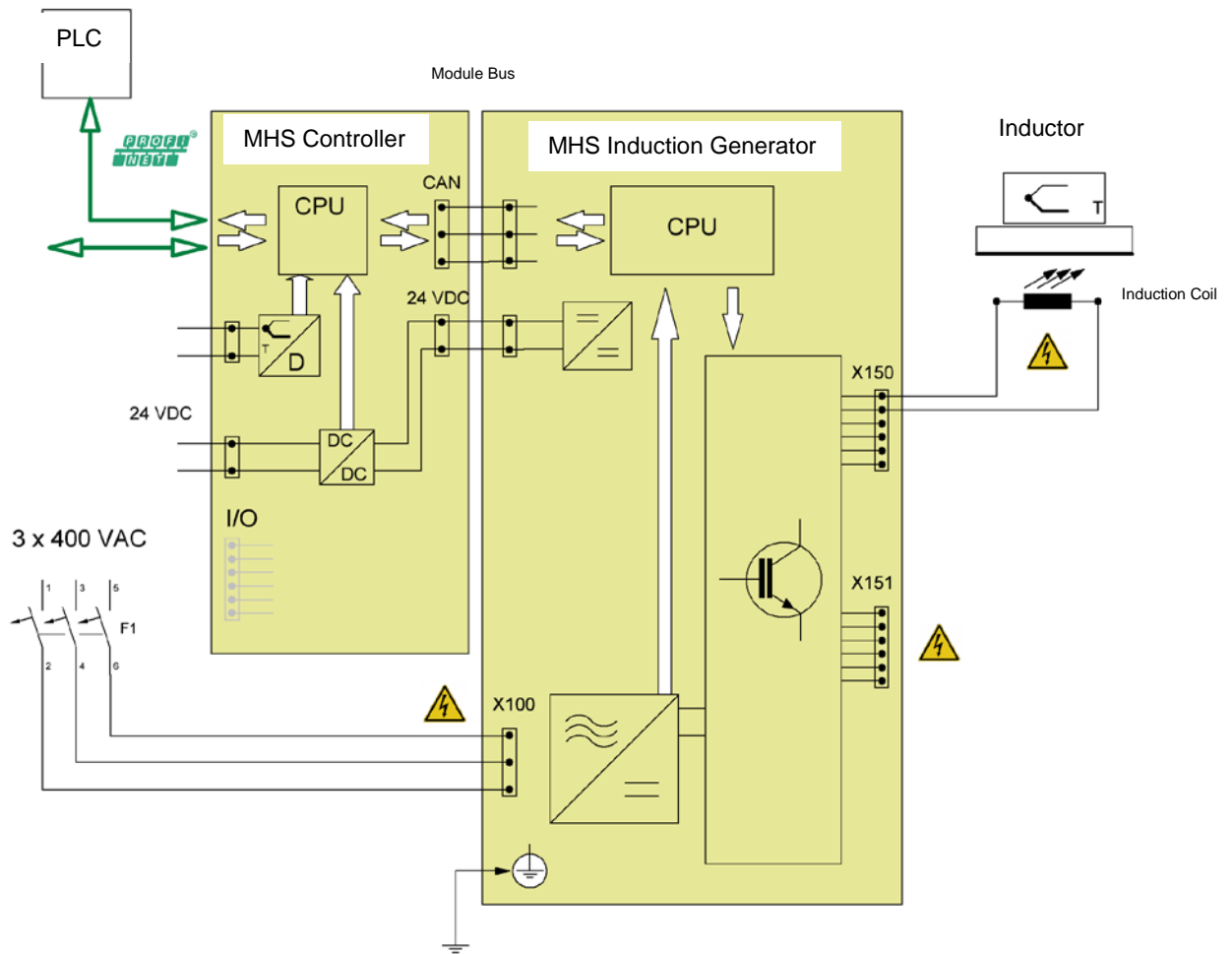

2.5 Application

2.5.1 Intended Use

The MHS-series units are designed to inductively heat tools and materials in industrial environments. MHS induction generators and the MHS Controller install and operate in a switching cabinet. The associated induction coils separately install in the machines concerned. Mind to only operate the units with MHS-series induction coils approved by Kendrion.

	CAUTION
	<p><i>Risk of burns by high surface temperature</i></p> <p><i>The surfaces of both the induction coils and the MHS generator may become very hot. Touching a hot surface may cause serious burns.</i></p> <ul style="list-style-type: none"> ⇒ Mount the components such that touching them is prevented. If that proves to be impossible, attach clearly visible and comprehensible warning signs to the hazard spots. ⇒ Provide some space around the components to ensure proper ventilation and to prevent adjacent components from being damaged by heat.

2.5.2 Foreseeable Misuse

Place of installation

Both the MHS Controller and the MHS induction generators provide IP 20 protection and should be protected against humidity and dirt.

The units emit exhaust hot air into the ambient space. Verify that the place of installation is ventilated properly. Refer to section Technical Data for waste heat details.

	NOTE
	<p><i>Damage to the unit</i></p> <p><i>Choosing the wrong place of installation may cause damage to the unit.</i></p> <ul style="list-style-type: none"> ⇒ Check section Technical Data for the admissible ambient conditions and the unit's mounting position.

Connection

The MHS Generator will only operate in conjunction with an MHS Controller supplied by Kendrion Kuhnke. Running it with a third-party unit is not supported.

	NOTE
	<p><i>Damage to the unit</i></p> <p><i>A wrong combination of units may destroy the device.</i></p> <ul style="list-style-type: none"> ⇒ Please note that the operating unit may be connected the MHS Controller only.

Design constraints for high-risk activities

The product is not fault tolerant and has neither been designed nor manufactured for applications requiring faultless operation during which a failure of the product would cause fatality, serious personal injury or serious material or environmental damage ("high-risk activities").

	DANGER
	<p><i>Danger caused by malfunctions</i></p> <p>Fatality, serious personal injury or serious material or environmental damage</p> <ul style="list-style-type: none">⇒ Do not use the product for applications requiring faultless operation during which a failure of the licenced product would cause fatality, serious personal injury or serious material or environmental damage.

2.6 Technical Data

2.6.1 General MHS Induction Generator Specifications

General Specifications		
Product name	MHS Induction Generator ...	
Article number	610 6XX XXX	
Load type	Induction coils to specifications	
Number of channels	Max. 6 separately actuated channels	
Operating frequency	2 - 25 kHz, operating point determined automatically	
Ports	CAN (internal module bus)	
Functions	On-board performance measurement, short circuit detection, DC link voltage monitoring, automatic frequency adjustment, resonant frequency monitoring	
Logic power supply	SELV/PELV 24 VDC \pm 10% (via module bus), approx. 500 mA	
Mains power supply	3 x 400 VAC +10% /-15%; 50/60 Hz	
Mains types	TT or TN	
Output	Continuous power	Peak power
Per channel, 6-chnl (610 660 00)	3 kW	3 kW
Per unit, 6-chnl (610 660 00)	18 kW	18 kW
Per channel, 4-chnl (610 640 00)	6.5 kW	7.5 kW
Per unit, 4-chnl (610 640 00)	26 kW	30 kW (max. 10 min., heat sink < 80 °C)
Power consumption 6-channel (610 660 00)	26 A	26 A
Power consumption 4-channel (610 640 00)	38 A	44 A
Fusing	Max. 50 A	
Cooling	Active via axial fan	
Power loss	Max. 350 W (depending on variant)	
Noise immunity	Zone B to EN 61131-2, Installation in earthed switching cabinet	
Storage and transport conditions		
Temperature	-25 °C ... + 70 °C	
Rel. humidity	5% ... 95%, non-condensing	
Service conditions		
Ingress protection	IP20	
Mounting position	Vertical, stackable	
Heat dissipation	Self-ventilation	
Storage temperature	-25 °C...+70 °C	
Operating temperature	0 °C...+35 °C (max. +40 °C at derated output)	
Rel. humidity	5% ... 95%, non-condensing	
Vibration	10 Hz to 57 Hz: +/- 0.075 mm amplitude, 57 Hz to 150 Hz: 10 m/ s ² (1g) to IEC 60068-2-6:2007, Fc test	
Shock	150 m/s ² (15g), 11 ms semi-sinusoidal wave to IEC 60068-2-27	
Degree of contamination	2	
Working altitude above msl	max. 2000 m	

Mechanical properties	
Installation	Prepared for installation on mounting panels in switching cabinet
Housing	Book-size steel sheet casing with stainless steel cover
Dimensions [H x W x D]	451 x 105 x 313
Protective earth	6 mm bolt, labelled on mounting panel

2.6.2 Dimensions

Refer to section 6 for exact dimensions

3 Construction and Functionality

3.1 Brief Description

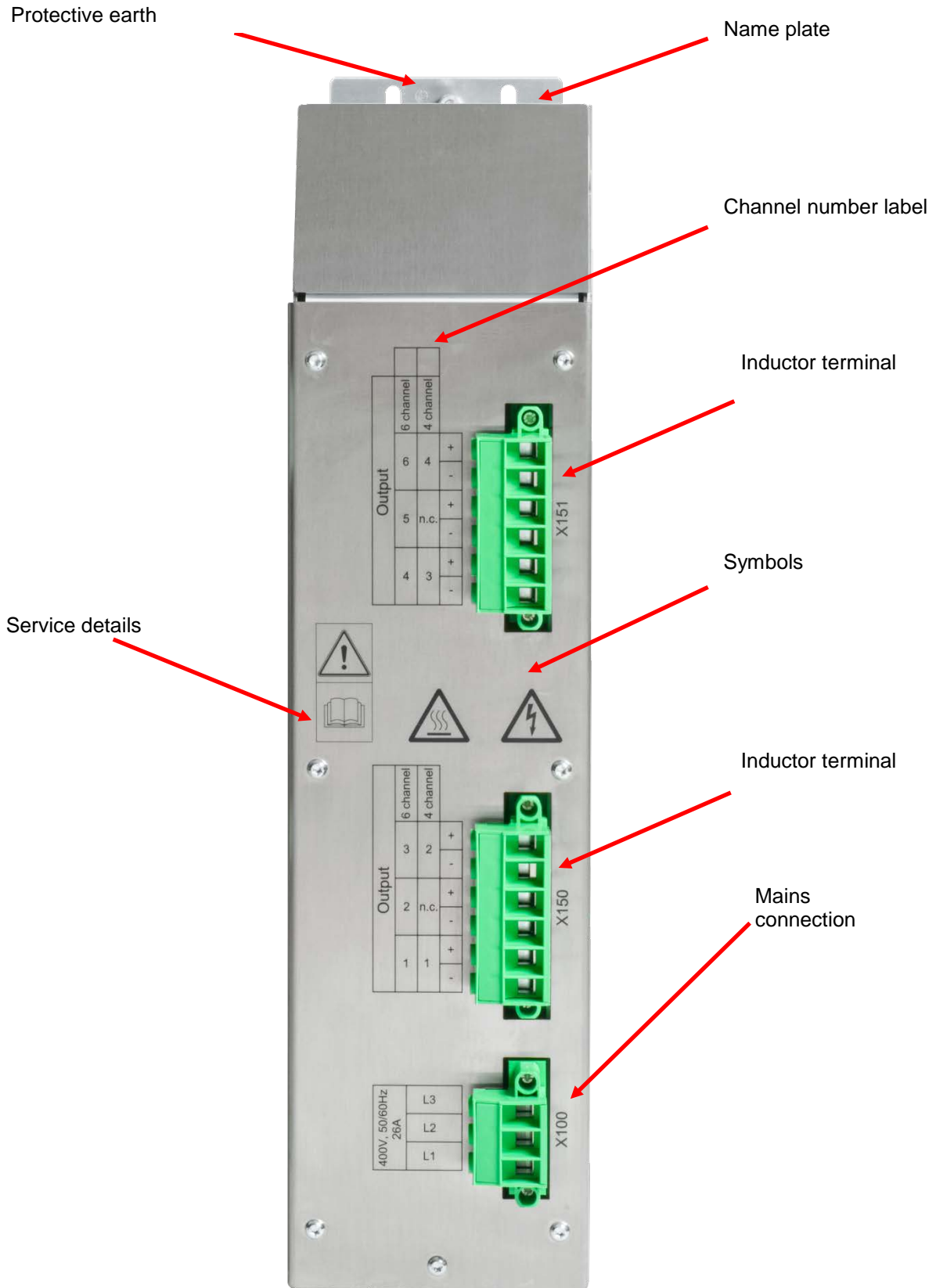

Labelling and Identification

Name plate (example)

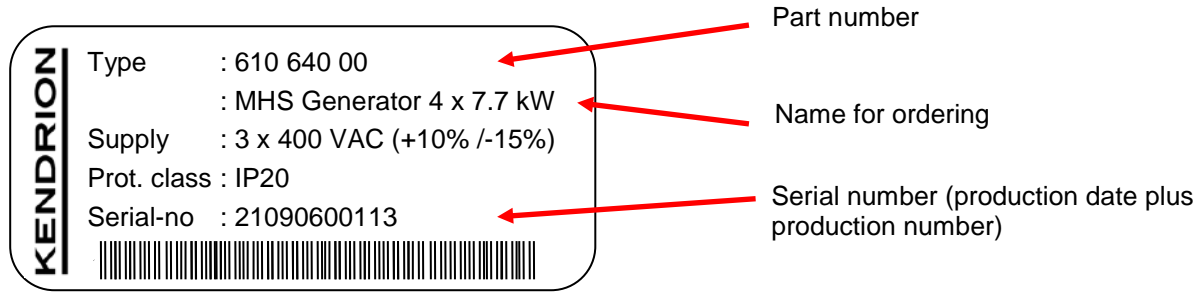

Serial Number

The numerical code incorporates the production date and a serial number. Kendrion Kuhnke can use the numerical code to distinctly identify the model, software and hardware release date. It is a means of traceability.

Make-up of Serial Number

YY MM DD NNNNN

Example:

The unit shown above is number 00113 manufactured on 06th September 2019.

19 09 06 00113

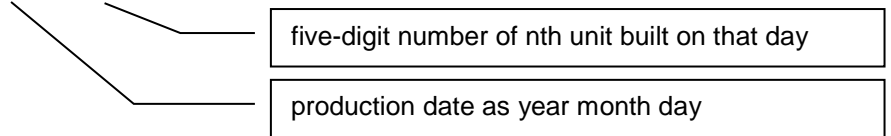



Manufacturer and service details

Look at the lateral device trough to find the manufacturer's address and other service details of the unit.

Signs

Signs used throughout the manual and on the unit are intended to make you aware of hazards or to provide useful information. For the most part, the signs are self-explanatory, but look for further details in this manual.

	Warning, electric shock hazard
	Warning, hot surface
	Note, refer to the manual

3.2 Contents of Package

The control unit package contains:

Basic device

Mating connector (as agreed)



Stuffing



3.3 Transport and Storage

Despite the unit's rugged construction, its components are still sensitive to impact and vibration. Transport and keep the unit in its original packaging and ensure that the ambient conditions are as specified at all times during transport and storage.

Refer to manual section → 2.6.1 General MHS Induction Generator Specifications for admissible ambient and transport condition details.

	<p>DANGER</p> <p><i>Risk of injury by dangerous voltages!</i></p> <p><i>The housing protects the operator and installer against dangerous contact voltage.</i></p> <p>⇒ <i>If you find any damages, do not put the unit into operation.</i></p>
	<p>NOTE</p> <p><i>Humidity</i></p> <p><i>Damage to the unit</i></p> <p>⇒ <i>Verify that no moisture (condensation) is able to collect on the unit when transporting it in cold temperatures or if it is exposed to extremely varying temperatures. Allow the unit to slowly warm up to room temperature before putting it into operation.</i></p>

**NOTE****ESD***Damage to the unit*

- ⇒ Even very small electrostatic discharge (ESD) will cause defects that may shorten the life of electronic components.
Use the original package to transport the unit and install the units in an ESD-compliant manner.

**NOTE****Damage***Damage to the unit*

- ⇒ In case you discover traces of damage on the outer package, immediately open the package and inspect the unit. If you find any damages, do not put the unit into operation but contact Kendrion Kuhnke to discuss how to proceed.

3.4 Control Unit Layout

All external connectors are located at the front of the unit. All connectors are of the plug-in type.

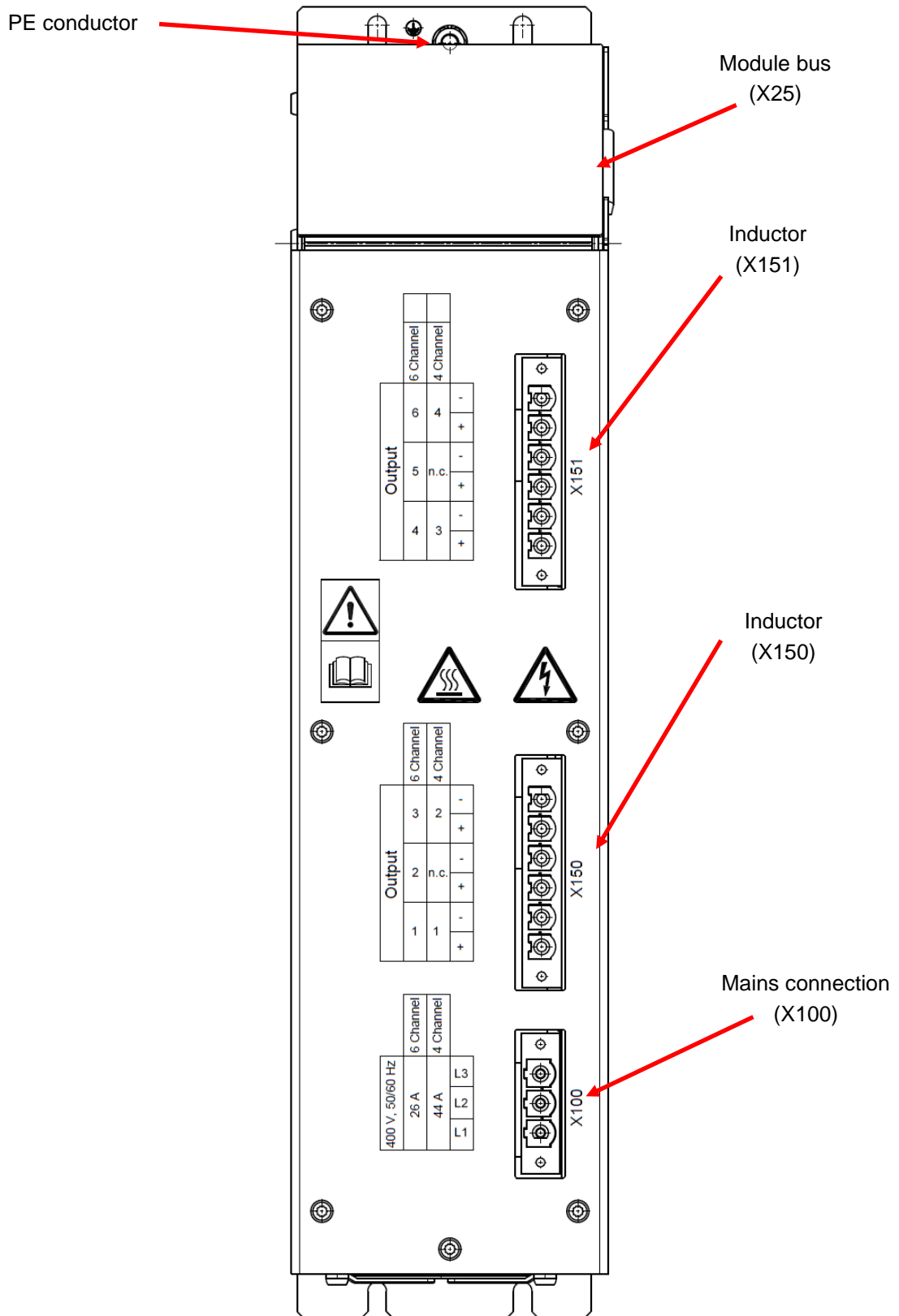

3.4.1 Power Supply (X100)

Power is supplied via terminal X100. The cord must have external protection against short circuit and overload tripping at max. 50 A (e.g. 50 A micro circuit breaker, 3-pin, tripping characteristic B). Admissible cross-section of cord: 16 mm².



Mains connection: 3x 400 VAC (50 Hz / 60 Hz) +10% /-15%
 3-pin male connector with screw terminal and screw flange
 Max. cross-section, flexible wire with connector sleeve: 16 mm²

X100 24 VDC Mains Power Supply		
Male plug	Pin	Function
Phoenix PC16 Part no.: 1967469	1	Phase L1
	2	Phase L2
	3	Phase L3

Technical data

Mains power supply		
Variant	6-channel	4-channel
Quantity	3	
Supply voltage	400 VAC +10% /-15%	
Network configuration	TT or TN	
Frequency	50/60 Hz	
Power consumption nom./peak load	26/26 A	38/44 A
Fusing	35 A	50 A
Max. wire cross section	16 mm ²	
Min. wire cross section	6 mm ²	10 mm ²
Tightening torque	1.7 – 1.8 Nm	

Refer to Phönix Contact's data sheet for further details of the connector.

3.4.2 Connecting the Induction Coils (X150), (X151)

The induction coils connect via 6-pole connectors with screw terminals (Phoenix). The connectors plug in at the front and can be coded.

Connection: 6-pole, screwed with spring bushing

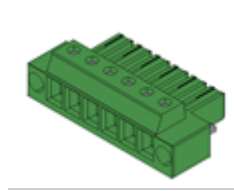

X150 Inductors			
Male plug	Pin	6-channel MHS gen. Function	4-channel MHS gen. Function
Phoenix IPC 16 Part no.: 1969496	1	+ CH1	+ CH1
	2	- CH1	- CH1
	3	+ CH2	n.c.
	4	- CH2	n.c.
	5	+ CH3	+ CH2
	6	- CH3	- CH2

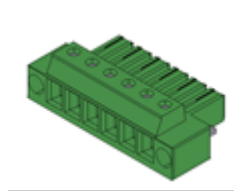

X151 Inductors			
Male plug	Pin	6-channel MHS gen. Function	4-channel MHS gen. Function
Phoenix IPC 16 Part no.: 1969496	1	+ CH4	+ CH3
	2	- CH4	- CH3
	3	+ CH5	n.c.
	4	- CH5	n.c.
	5	+ CH6	+ CH4
	6	- CH6	- CH4

Technical data

Inductors		
Variant	6-channel	4-channel
Supply voltage	Max. 1,000 Veff	
Frequency	Max. 25 kHz	
Nominal power consumption	11 A	27 A
Max. wire cross section	Max. 16 mm ²	
Min. wire cross section	2.5 mm ²	6 mm ²
Tightening torque	1.7 – 1.8 Nm	
Maximum line length	20 m	

Refer to Phönix Contact's data sheet for further details of the connector.

3.4.3 Module Bus (X25)

20-pin box header connector on circuit board

System link between the MHS Controller and up to 7 MHS generator modules. Only use the module bus cable from the MHS Controller package.

3.4.4 PE Conductor



The induction generator is designed for installation in a switching cabinet whose IP 20 housing provides sufficient protection against direct contact. Attach a protective earth conductor to provide for protection against indirect contact in case of a fault to frame. Connection is made to the 6 mm bolt on top of the device.

3.4.5 Indicators and Controls

The status of the MHS generator modules is not indicated directly.

Check the MHS Controller's indicators for the information instead.

The Controller's fieldbus provides detailed status information.

For the available status indications see section .

4 Installation and Putting into Service

	<p>Information</p> <p><i>Before installing, servicing or putting the basic module and the display into operation, please also read the safety information in the preface of this document.</i></p>
---	---

4.1 Mechanical Installation

General

- Use suitable tools to avoid damages when mounting and plugging the connectors
- Before installing the unit, check that it is undamaged and free from foreign objects

Notes on the location of installation

The induction generator is designed for installation in an enclosed switching cabinet or in similar closed operating rooms. The design and make of the switching cabinet are essential for limiting the amount of dirt and the ambient temperature as well as for ensuring the EMC properties. Please take heed of the following recommendations.

- Do not allow the units to contaminate more than specified for degree II in IEC 60664. Whereas an enclosure providing IP 54 protection (e.g. an appropriate control cabinet) ensures that degree of contamination II is complied with, please consider that operation under condensing humidity is NOT allowed.
- In order to avoid dirt, excess temperature or condensation, consider equipping the cabinet with adequate means of ventilation/filtering/cooling.
- We recommend installing a ventilator alarm or thermo-guard in air-cooled switching cabinets.
- Use an earthed switching cabinet.
- Use conducting profiles or other conducting material for the seals. Keep openings and cable ducts as small as possible.
- Use a braided earth strap to connect to ground and to reduce HF resistances.
- Use short earth conductors or suitable earth straps to connect the installed devices to earth.
- Do not install or operate sensitive radio communication devices in the unit's immediate vicinity.

	<p>WARNING</p> <p>Potentially hazardous failures due to contamination</p> <p><i>Contaminations more severe than those described for degree of contamination II of IEC 60664 may cause potentially hazardous failures.</i></p> <p>⇒ Do ensure that the operating environment complies with at least IP 54, e.g. by installing the unit in a suitable control cabinet.</p>
---	--

	<p>WARNING</p> <p>Potentially hazardous failures due to high temperatures</p> <p><i>Ambient temperatures higher than those specified in section Technical Data may cause potentially hazardous failures.</i></p> <p>⇒ Do provide a proper operating environment, e.g. by adequately ventilating or cooling the location of installation.</p>
---	--

	<p>WARNING</p>
---	-----------------------

**Potentially hazardous failures due to escaping hot air**

Air up to 90 °C hot may escape from the top of the units.

⇒ Avoid heat-sensitive components getting into the airflow.

**DANGER*****Risk of injury by hot surfaces!***

Air up to 90 °C hot may escape from the top of the units and heat up the surfaces.

⇒ *Check if the surface is hot before you touch the units.*

4.1.1 Preparatory Steps



NOTE

To avoid accidents, disconnect the unit from the mains prior to installing or servicing it. Install the units in a suitable housing and protect them against dirt. Only qualified persons to set up and service the unit!

Take heed of the following regulations:

DIN VDE 0100, part 460

DIN VDE 0113, part 1

DIN VDE 660, part 100

DIN EN 50178

DIN VDE 0100, part 725

DIN VDE 0160

DIN VDE 0660, part 102

IEC 947-4-1

4.1.2 Mounting Position

The unit is intended for mounting vertically in the switching cabinet with their connectors pointing to the front. Properly screw down the MHS Controller to the left of the first induction generator. All other (optional) induction generators install at 2 ... 5 mm distance to the right of the first induction generator.

Screw the base plate of the units to the mounting surface inside the cabinet. Refer to the attached drawing 6.2.2 Mounting Dimensions for the base plate dimensions.

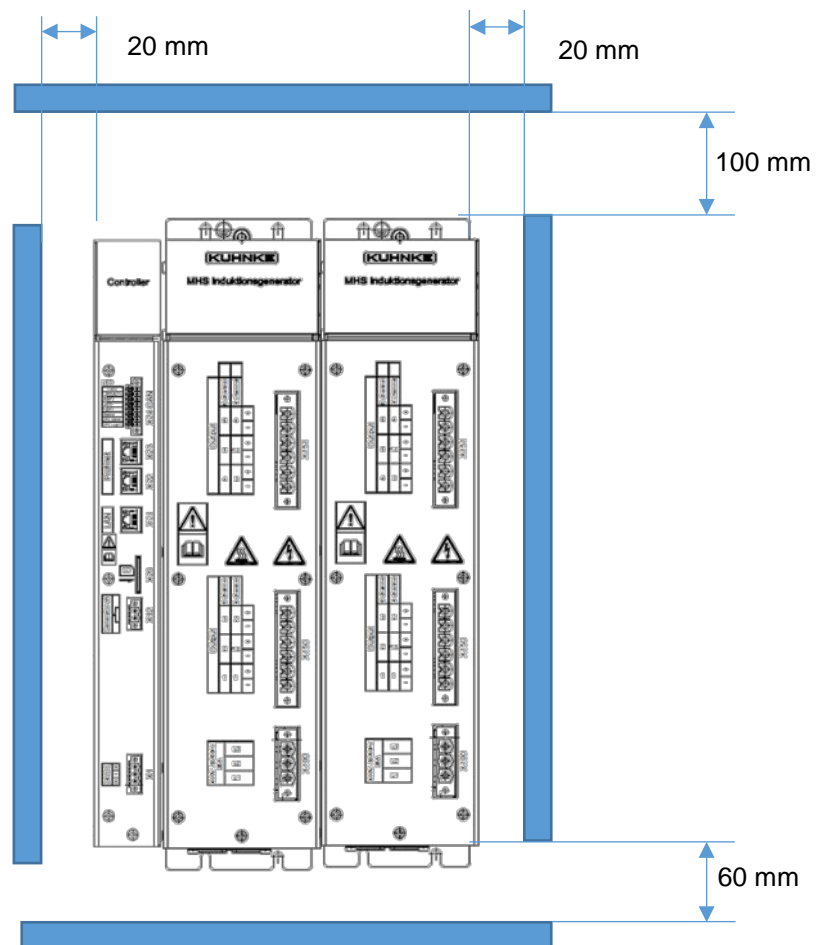

4.1.3 Free Ambient Space

To ensure that enough air gets in, leave at least 100 mm to the top and 60 mm to adjacent devices or cabinet surfaces below. Leave at least 20 mm of lateral distance to third-party units and cabinet surfaces.

4.1.4 Fastening Bores

There are 4 M6 bolts for attaching the unit on the switching cabinet's mounting panel. Refer to the enclosed drawing for the exact bore hole dimensions. Consider a gap 2 ... 5 mm wide between any further generators you may wish to install. Apply the specified torque to tighten the 6 mm bolts.

4.1.5 Connecting two Power Modules

The modular heating system's power modules are stand-alone units that do not interlink mechanically in the line-up. To ensure that the module bus will properly interlink the devices, check that they are not more than 5 mm apart and that their horizontal alignment runs out by not more than 3 mm.

4.2 Electrical Installation

4.2.1 General

Only qualified persons are allowed to perform the electrical installation. Check that the unit is de-energised before installing it.

	WARNING
	<p>Potentially hazardous voltage</p> <p><i>Owing to the functionality of induction coils and the mains voltage supplied, the leads connecting these elements may carry very high voltages which may cause an electric shock during installation and maintenance.</i></p> <p><i>Preventive measures:</i></p> <ul style="list-style-type: none"> ⇒ De-energise the unit every time before working on it. ⇒ Before starting to work, verify that the unit is actually de-energised. ⇒ To allow the discharge of internal capacities, wait for 1 minute after disconnecting the unit before you start working on it.

4.2.2 Line Interfacing

General instructions

- Only use approved and undamaged mating connectors for the electrical installation.
- The screw fitting on the flange ensures that the connector is tightly and reliably attached.
- Use suitable tools to avoid damages when mounting and plugging the connectors
- Only use undamaged mating connectors for the electrical connection.
- Verify that the leads make tight and reliable contact in the mating connector.
- To unplug a connector, do not pull the cable but hold the connector by its housing.
- To avoid excessive force being exerted on the board, do not expose the connectors to inadmissibly high tension / pressure. One reason for too much pulling force is the wiring being too short.
- The unit's connectors are not designed for use as a strain relief. To ensure that the connector contacts remain reliably attached in the long run, relieve the strain exerted on cables and leads by both dynamic and static loads inside the control cubicle.

	WARNING
	<p>Leads coming off because of loads on the terminals</p> <p><i>Dynamic and/or static loads occurring inside the control cubicle will strain the soldered joints of connectors and terminals which may lead to connectors or single leads coming off. and to cause a risk of an electric shock.</i></p> <ul style="list-style-type: none"> ⇒ Minimise the forces affecting the connectors and terminals by installing suitable means of strain relief in the control cubicle.

- Periodically check the terminals and the PE terminal for the correct torques.

Shielding

Shielding is a means of mitigating (damping) magnetic, electric or electromagnetic noise fields. The shield bus and its conductive link to the housing will discharge interfering currents on the cable shields into earth. While the PE terminal provides current discharge from the induction generators, its performance can be improved by adding a braided earth strap.

4.2.3 Electrical Connection

Protective earth

	WARNING
	<p><i>Lethal risk of electric shock due to unearthed unit!</i></p> <p><i>If units feature no or a badly installed PE terminal, high currents may occur on non-covered parts. Touching such parts may cause serious injury or death</i></p> <ul style="list-style-type: none">⇒ Properly connect the unit to earth.⇒ Connecting the PE terminal is subject to the applicable national and local regulations.

Attach a protective earth conductor to provide for protection against indirect contact in case of a fault to frame. Connection is made to the 6 mm bolt on top of the device.



- Do use a crimp terminal lug (approved pursuant to DIN 46234, for example) for a 6 mm bolt matching the cross-section of the chosen cable.
- The cross-section of the PE conductor not to be less than:
10 mm² Cu or 16 mm² Al.
- Try to keep the lead to the earthing terminal as short as possible.
- Connecting the PE terminal is subject to the applicable national and local regulations.
- Apply a torque of 3 Nm to tighten the 6 mm bolt.
- If several induction generators are connected in series, mind to connect each one of them to a separate PE terminal.

	NOTE
	<p><i>Installation to conform to the protective earth connection regulations of IEC 61010-1!</i></p>

Mains and inductor connection (power supply: X100, coils: X150, X151)

The cable you choose should have a cross-section matching the place and method of installation, voltage and current loads and the conductors' operating temperature specified in the standard applicable to the scheduled installation room. Use the ring connectors and tightening torques specified for the junction.

For connector details see [section 3.4.1](#) and [section 3.4.2](#)

	WARNING
	<p>Lethal risk by electric shock due to excessive mains voltage!</p> <p><i>Supplying higher voltages than specified in the technical data may damage the unit and cause a risk of fire and electric shock.</i></p> <p>⇒ Do not connect higher voltages than the nominal voltage of the unit.</p>

Correct inductor cable

The nominal voltage U_0 of the inductors ranges up to 800 V_{eff}. If power is supplied to two inductors through the same cable, the phase shift of 180° may cause the voltage between the conductors to rise to $U = 1600$ V (chaining factor 2). Connect the inductors with leads rated at the high voltages and currents to be expected.

More often than not, the areas around the connectors and, thus, the inductor leads will get warm. Verify that both the leads and the terminals will withstand the temperatures to be expected.

	WARNING
	<p>Lethal risk by electric shock due to wrongly rated leads!</p> <p><i>A wrong rating of the lead properties may damage the unit and cause a risk of fire and electric shock.</i></p> <p>⇒ Verify that the electrical properties (electric strength, thermal stability) of the leads meet the actual requirements.</p>

4.2.4 Power supply fusing

	WARNING
	<p>Risk of fire due to short circuit or overload!</p> <p><i>A short circuit in the module or the power supply lines may cause the system to overheat or provoke a fire.</i></p> <p><i>Preventive measures:</i></p> <ul style="list-style-type: none"> ⇒ Provide a suitable safety switch or fuses near the induction generator. Check that its or their tripping current matches the needs of your application. ⇒ Only use approved induction coils as the load. ⇒ Do not overload the MHS Generator by excessive temperature settings.

Verify that suitable safety switches or lead fuses are installed between the power supply and the induction generator and check that the current rating of the safety switches/fuses matches the load.

Wiring example

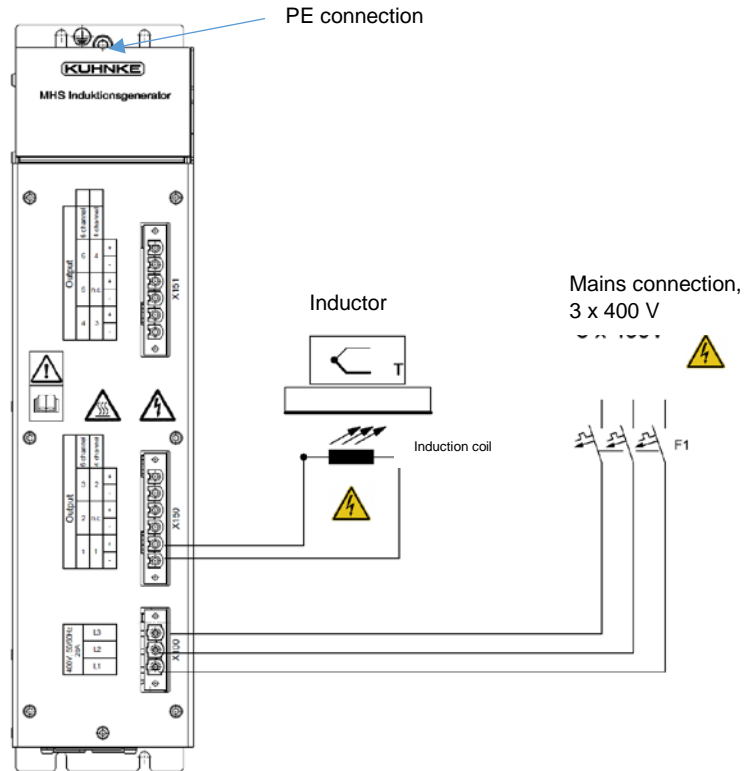

CAUTION

Risk of electric shock

The mains and coil connections carry dangerously high voltages. Inappropriate wiring or bad insulation may result in high contact voltages.

- ⇒ Provide means of contact protection!
Protect the entire mains wiring against contact and affix appropriate hazard warnings to the installation!
- ⇒ Check that the coils are properly wired and that each lead is unmistakably allocated to a particular channel.
- ⇒ Minimise the forces affecting the connectors and terminals by installing suitable means of strain relief in the control cubicle.

24 VDC power supply

The MHS Controller provides 24 VDC power which the module bus supplies to the unit. The Controller limits the current to approx. 5 A.

Interconnecting units

To operate the MHS Controller with up to 7 output stages, mind to interconnect adjacent units by means of the module bus. Look under the slanting service flaps at the front of the units to find the female module bus connectors. Interconnect the units using the module bus cable from the MHS Controller package. Simply plug the male module bus connectors to their female counterparts on the units. Every Controller supports up to 7 generators.

Plug the first socket assembly into the Controller trough, lay the cable to the first output stage and plug it in there. Proceed as before to connect further output stages using the module connector.

In case the module connector has too many lead-outs, simply cut the excess length of cable to be flush with the last socket assembly before you install it. You cannot extend the module bus connector.

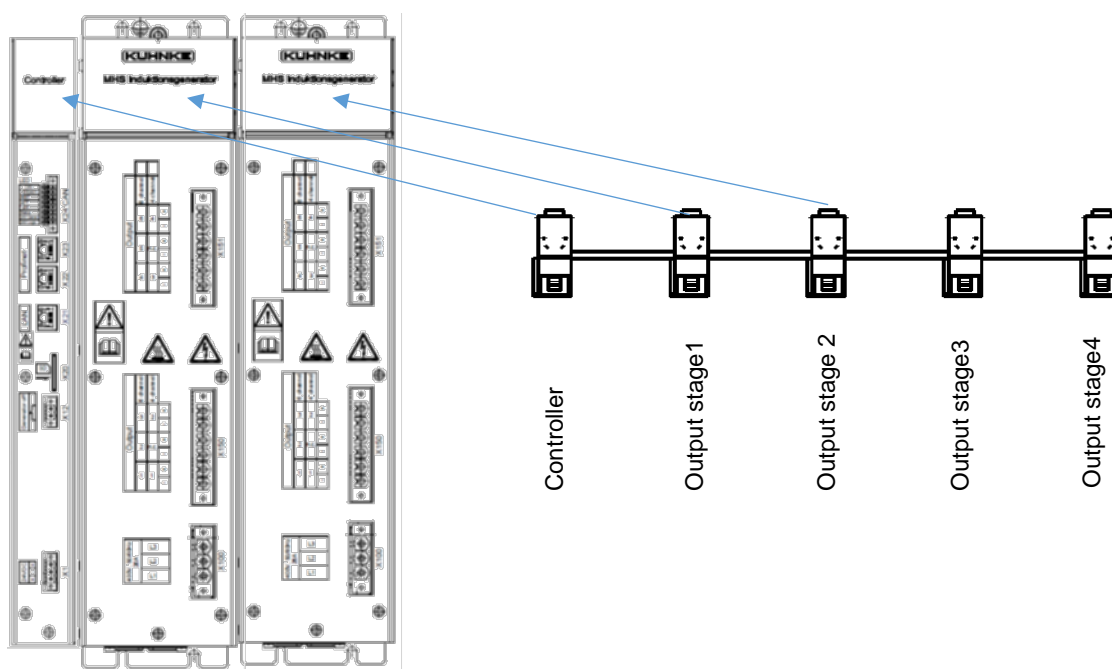

NOTE

To avoid accidents and potential damage, disconnect the unit from the mains prior to installing it.

4.3 Configuration

4.3.1 Module Bus Addresses

The module bus addresses are set by the strands of the module bus connector. Generator 1 is located to the right of the MHS Controller. The second and further generators follow on the right-hand side. Every MHS Controller supports up to 7 generators.

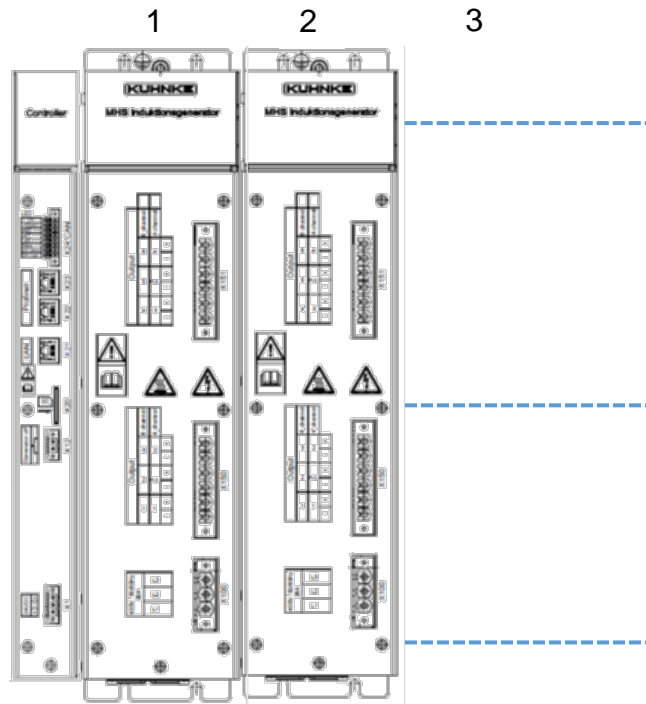

4.3.2 Installing the Software

Only qualified persons are allowed to do the configuring and programming.

4.3.3 Address Setup

The module bus connection automatically sets the addresses of systems consisting of one MHS Controller and up to 7 MHS output stages. The module bus connects under the flaps at the front of the interconnected modules.

4.4 Putting into Service

4.4.1 General Notes

- Only qualified persons are allowed to put the unit into service.
- As component parts of machines, facilities and systems, electronic control systems must comply with valid rules and regulations, depending on their field of application.
- Take one step at a time to put the unit into service.
- Verify that all active components respond as they should.
- Run a complete test cycle of the application.

4.4.2 Start-up Prerequisites

- Protective earth is connected to every generator.
- One MHS Controller is properly linked and connected to the MHS generators.
- Both the generators' connecting leads and the module bus are correctly connected.
- Power is supplied to the unit.

	CAUTION
	<p><i>Wrong or excessive supply voltage</i> <i>Electric shock hazard</i></p> <p>⇒ Do not plug, mount, unplug or touch the connectors during operation! You may otherwise provoke destruction or malfunction. Turn off all power sources before working on the unit. This also applies to any peripherals connected such as encoders, programming devices with external power source, etc.</p> <p>⇒ Do not use devices connected to the wrong or excessive voltage.</p>

4.5 Operating Functions

4.5.1 State Machine

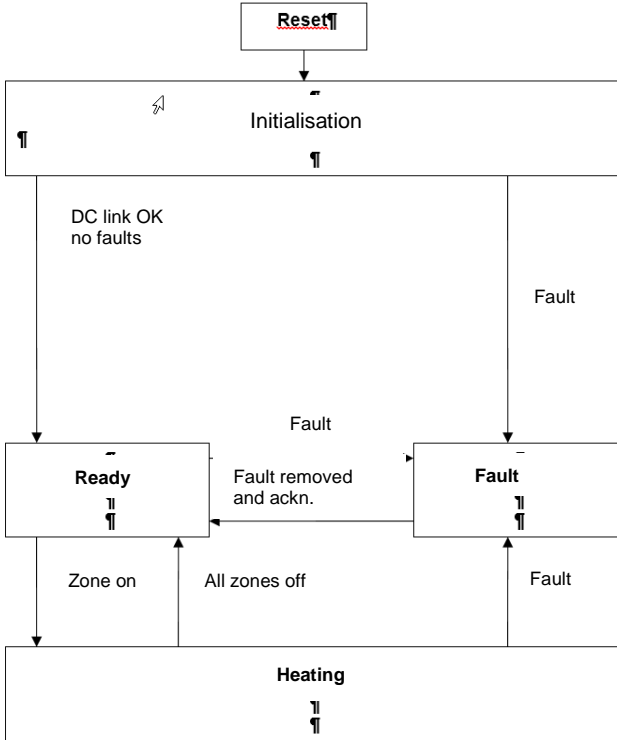

4.5.2 Finding the Resonance Frequency.

The generators can adapt their operating frequency to the resonance frequency of the resonant circuit. You need to set one frequency (admissible range is 1 – 25 kHz).

The generator checks if the actual resonance frequency of the resonant circuit is within $\pm 30\%$ of the set value. If it fails, it will try again.

If it fails again, it will generate a fault.

The frequency of all active inductors is measured when the first heating zone activates.

It is not repeated in normal heating mode.

The same frequency (average of all frequencies found) is applied to the inductors connected to the bus. The inductors' frequencies should not deviate by more than 5% from this average.

You can disable the frequency search by setting bit 9 of the control word = high.

Please check back with Kendrion before you do.

The resonance frequency of each of the zones is mapped onto the Controller's input data (section 6.4), provided that the Controller is running in set mode.

As opposed to that, the Controller's input data always reflect the actual operating frequency.

Input Data, 50 Bytes per Generator Module (Control Head -> Control Unit)

Name	Format	Range	Unit
Status word GM1	DWORD		
Actual GM1 – Z1 (control TempSensor = 1) ResFreq – Z1 (control off TempSensor = 0)	WORD	0.. 3000 1000 ..30000	0.1 °C 1.0 Hz
Actual GM1 – Z2 (control TempSensor = 1) ResFreq – Z2 (control off TempSensor = 0)	WORD	0.. 3000 1000 ..30000	0.1 °C 1.0 Hz
Actual GM1 – Z3 (control TempSensor = 1) ResFreq – Z3 (control off TempSensor = 0)	WORD	0.. 3000 1000 ..30000	0.1 °C 1.0 Hz
Actual GM1 – Z4 (control TempSensor = 1) ResFreq – Z4 (control off TempSensor = 0)	WORD	0.. 3000 1000 ..30000	0.1 °C 1.0 Hz
Actual GM1 – Z5 (control TempSensor = 1) ResFreq – Z5 (control off TempSensor = 0)	WORD	0.. 3000 1000 ..30000	0.1 °C 1.0 Hz
Actual GM1 – Z6 (control TempSensor = 1) ResFreq – Z6 (control off TempSensor = 0)	WORD	0.. 3000 1000 ..30000	0.1 °C 1.0 Hz
...
...
Resonance frequency	WORD	1000..30000	1 Hz



NOTE

Running the inductors outside of the resonance frequency tolerance will increase the power loss across the generator.

- ⇒ **Always enable resonance frequency detection to operate the unit.**
- ⇒ **Use inductors of the same inductance and capacity ratings only.**

4.5.3 Frequency Adjustment

Depending on which inductor you are using, its resonance frequency will vary with the temperature of both the heated object and the inductor. Since the generator will keep using the original frequency until the heating cycle is stopped, you may find that the units are not maintaining their optimum operating frequency.

One option is to briefly stop and restart the heater after the temperature has changed. This will repeat the search for the average resonance frequency.

Another option is to enable the generator's frequency adjustment function. In that case, the resonance frequency will readjust. **Special version!**

To enable the function, set bit 10 of the status message = high.

Contact Kendrion and ask for this software option.

It uses a correction factor determined in a real-life inductor and then stored in the generators.

Please contact Kendrion if you need this functionality.

4.5.4 Short Circuit Detection

The generators monitor the connected output for overcurrent events.

The trigger threshold is approx. 150% of the admissible peak load.

Outputs connect to the "+CHx" terminal of ports X150 / X151.

A short circuit provokes an error message. There should be a delay of one minute between any two short circuit events.

Generator Module Faults			
Bit	IF bit = high	IF bit = low	
10	short circuit channel 1	channel 1 ok	F
11	short circuit channel 2	channel 2 ok	F
12	short circuit channel 3	channel 3 ok	F
13	short circuit channel 4	channel 4 ok	F
14	short circuit channel 5	channel 5 ok	F
15	short circuit channel 6	channel 6 ok	F

	NOTE
	<p><i>A short circuit puts significant stress on the generator module components.</i></p> <ul style="list-style-type: none"> ⇒ <i>Check your installation for potential short circuits.</i> ⇒ <i>There should be a delay of at least one minute between any two short circuits.</i> ⇒ <i>The components will withstand 1,000 short circuits during their lifetime.</i>

4.5.5 Measuring the Capacity and Current

The system measures actual output capacities or currents and sends the readings via the Controller's fieldbus.

To display the rms reading of all zones, set bit 13 of the generator module's control word.

Input Data, 50 Bytes per Generator Module (Control Head -> Control Unit)			
Name	Format	Range	Unit
Power GM1 – Z1	WORD	0..1000	0.1 kW / (A)
Power GM1 – Z2	WORD	0..1000	0.1 kW / (A)
Power GM1 – Z3	WORD	0..1000	0.1 kW / (A)
Power GM1 – Z4	WORD	0..1000	0.1 kW / (A)
Power GM1 – Z5	WORD	0..1000	0.1 kW / (A)
Power GM1 – Z6	WORD	0..1000	0.1 kW / (A)

4.5.6 DC Link Monitoring

Load supply downstream internal rectification is called a DC link.

Limits of the DC link voltage are monitored.

Voltage low (<440 VDC): Status = Warning/Caution: Carrying out a search for the resonance frequency at low voltage provokes a 'heating current' error.

Voltage high (>670 VDC): Status = Warning: Heating is suspended and resumed when the voltage has dropped below the threshold.

Generator Module Faults			
Bit	IF bit = high	IF bit = low	
6	DC link fault	DC link ok	W

4.5.7 24 VDC Power Supply Monitoring

Limits of the 24 V power supplied by the module bus are monitored. Low voltage is considered a fault.

Generator Module Faults			
Bit	IF bit = high	IF bit = low	
3	low voltage, 24 V logic	24 V ok	F
4	low 24 V generator voltage	24 V IGBT ok	F

4.5.8 Heat Sink Temperature Monitoring

The heat sink temperature is measured and monitored.

Use the fieldbus interface to get the actual temperature readings.

The unit stores set thresholds (depending on variant).

Temperature warning: 70 °C – 85 °C

Temperature fault: 80 °C – 95 °C

Generator Module Faults			
Bit	IF bit = high	IF bit = low	
0	heat sink temperature warning	heat sink temperature ok	W
1	heat sink temperature fault	heat sink temperature ok	F



DANGER

Risk of injury by hot surfaces!

Air up to 95 °C hot may escape from the top of the units and heat up the surfaces.

⇒ *Check if the surface is hot before you touch the units.*

4.5.9 Watchdog Monitoring

The generator modules feature a watchdog timer. An unexpected problem during the programme run provokes a watchdog error.

Generator Module Faults			
Bit	IF bit = high	IF bit = low	
5	watchdog error	no watchdog error	W

4.5.10 Handshake

Both the control word and the status word of every induction generator contain a handshake bit. This bit monitors the communication between the master and the induction generator for any faults. Generator and user software in the master control unit check the two bits.

User software:

Compares the bits and toggles the appropriate handshake bit if the bits are found to be the same.

Generator firmware:

Compares the bits and toggles the appropriate handshake bit if the bits are found to differ. It also enables time monitoring when the first heating cycle starts. Within 5 seconds, the generator must detect both bits to be the same and toggle its own bit. After 5 seconds, the monitor will generate a fault.

Generator Module Faults			
Bit	IF bit = high	IF bit = low	
7	handshake bit fault	handshake ok	F

4.5.11 CAN Module Bus Monitoring

A module bus problem is detected by handshake monitoring, which stops the heating process after 5 seconds. CANbus communication is also monitored by the Controller and shown for the generator.

Generator Module Faults			
Bit	IF bit = high	IF bit = low	
9	CAN bus generator module fault	CAN bus generator module ok	F

4.6 Diagnosis

4.6.1 General

The MHS induction generator outputs error and other state signals to the LEDs and the fieldbus port of the MHS Controller.

- Any generator error message will disable the heating mode.
- Actively acknowledge an error message to clear it once the error has been removed.
- Warnings indicate an abnormality but will not disable the heating mode.
- To reset a warning, proceed as described for the error messages.

4.6.2 Generator Module Messages:

Status Word		
Bit	IF bit = high	IF bit = low
0	heating channel 1: confirmation	heating channel 1: off
1	heating channel 2: confirmation	heating channel 2: off
2	heating channel 3: confirmation	heating channel 3: off
3	heating channel 4: confirmation	heating channel 4: off
4	heating channel 5: confirmation	heating channel 5: off
5	heating channel 6: confirmation	heating channel 6: off
6		
7	active global error	no fault
8	confirm fault acknowledge	
9	resonance frequency search: off	resonance frequency search: on
10	frequency adjustment: enabled	frequency adjustment: disabled
11	actuation mode on, target = control	actuation mode off, control enabled
12	power limit. across all channels (from ch1)	power limit. by channel
13	DC link ok	DC link off
14	initialisation complete (ready)	initialising
15		handshake bit
16	control head: low voltage, 24 V	control head: 24 V voltage ok
17	control head: generator voltages low	control head: generator voltages ok
18	control head: 24 V overload	control head: 24 V current ok
19	control head: generator overload	control head: generator current ok 16
:	:	:
24	temp. sensor not allocated	all temp. sensors allocated
25	allocation enabled	allocation disabled / ready
26	temp. sensor, wrong allocation	allocation ok
27	temp. sensor, allocation requested	normal operation
:	:	:
:	:	:
31		

Generator Module Faults			
Bit	IF bit = high	IF bit = low	
0	heat sink temperature warning	heat sink temperature ok	W
1	heat sink temperature fault	heat sink temperature ok	F
2	-	-	-
3	low voltage, 24 V logic	24 V ok	F
4	low 24 V generator voltage	24 V IGBT ok	F
5	watchdog error	no watchdog error	W
6	DC link fault	DC link ok	W
7	handshake bit fault	handshake ok	F
8	current fault (ResFreq not found)	no current fault	F
9	CAN bus generator module fault	CAN bus generator module ok	F
10	short circuit channel 1	channel 1 ok	F
11	short circuit channel 2	channel 2 ok	F
12	short circuit channel 3	channel 3 ok	F
13	short circuit channel 4	channel 4 ok	F
14	short circuit channel 5	channel 5 ok	F
15	short circuit channel 6	channel 6 ok	F

4.6.3 Table of Faults

Table of Faults		
Description	Possible Cause	Recommended Action
Inductor short circuit	Inductor damaged (e.g. interturn short-circuit)	Check inductor for damage
	Inductor lead damaged	Check lead for damage
	Inductor too far away from heated element	Check inductor position
	If also heat sink temperature warning: output overload detected	Reduce output power to admissible range
Unit fails to heat	No 400 V power supply Mains fuse tripped	Check power supply at X100
	Inductor not or wrongly connected	Check that the inductors are correctly connected to X150 / X151
CAN bus module bus fault	Module bus plug not or wrongly connected	Check module bus connection
	Configuration does not match the units connected	Check configuration
Heat sink temperature fault	Ambient temperature too high	Improve ventilation or air-conditioning to reduce ambient temperature to $\leq 35\text{ °C}$
	Overload due to excessive output power	Reduce output power to admissible range
24 V logic voltage low	Logic power supply to controller too low or power not supplied	Change supply voltage to admissible range $24\text{ V} \pm 10\%$
24 V generator voltage low	Generator power supply to controller too low or power not supplied	Change supply voltage to admissible range $24\text{ V} \pm 10\%$
	Generator OFF contact X12 at controller (device variant) open	Check that connector X12 is plugged and that both pins are connected
Watchdog error	Internal device error due to unexpected event, e.g. EMC	Check installation for EMC measures
DC link error	X100 supply voltage not available	Check 400 VAC supply voltage
Handshake error	Master-to-generator communication	Check program flow and bus wiring

	problem	
Current fault (resonance frequency not found in resonant circuit)	Inductor not connected	Check inductor connection to X150/151
	Wrong inductor inductivity	Check inductor inductivity
	Wrong frequency selected	Check if actual resonance frequency of resonant circuit is within $\pm 20\%$ of set value.
	X100 supply voltage not available. Failure to start frequency search	Check 400 VAC supply voltage

5 Operation

Safe operation

Prevent inadmissible contamination while operating the induction generator. Do not use or continue to use the unit in case it has been exposed to inadmissible contamination.

Ambient temperatures higher than those specified in section Technical Data may cause failures. Do provide a proper operating environment, e.g. by adequately ventilating or cooling the location of installation.

Switching on and off

Normal operation

Error codes

The MHS induction generator outputs error and other state signals to the fieldbus port of the MHS Controller and from there to the higher-level control unit.

6 Maintenance / Servicing / Repairs

6.1 General

Only qualified persons are allowed to work on the unit.

	CAUTION
	<p><i>Lethal risk due to live parts!</i> <i>Electric shock hazard</i></p> <ul style="list-style-type: none"> ⇒ Do not plug, mount, unplug or touch the connectors during operation! You may otherwise provoke destruction or malfunction. ⇒ Before working on the unit, turn off all power sources, including those of peripherals such as MHS Controllers, encoders with external power source, etc. ⇒ Safeguard the energy sources against restart.

Only the manufacturer or customer service providers authorised by the manufacturer are allowed to do repairs and perform corrective maintenance.

6.2 Preventive Maintenance

MHS induction generators require neither servicing for the specified service life nor any action if they are kept and operated at the admissible ambient conditions specified in section Technical Data.

- Check every six months that all mains and earthing cables are properly attached and tightened. Retighten the cables and screw terminals as necessary.
- Check every month that the fans are working properly and that the ventilation slots in the cabinet are unobstructed.

Cleaning

Prevent inadmissible contamination while operating and storing the induction generator. Do not use or continue to use the unit in case it has been exposed to inadmissible contamination.

6.3 Repairs / Customer Service

	Information
	<p><i>Only the manufacturer or customer service providers authorised by the manufacturer are allowed to do repairs and perform corrective maintenance.</i></p>

6.4 Warranty

The statutory period and conditions of warranty apply. Warranty expires if unauthorised attempts are made to repair the unit / product or any other intervention is performed.

7 Taking out of Service / Uninstalling / Disposal

Taking out of Service

Check that the unit is de-energised before uninstalling it.

	WARNING
	<p>Potentially hazardous voltage</p> <p><i>Owing to the functionality of induction coils and the mains power supply, the leads connecting these elements may carry very high voltages which may cause an electric shock during installation, maintenance and uninstallation.</i></p> <p><i>Preventive measures:</i></p> <ul style="list-style-type: none">⇒ De-energise the unit every time before working on it.⇒ Before starting to work, verify that the unit is actually de-energised.⇒ To allow the discharge of internal capacities, wait for 1 minute after disconnecting the unit before you start working on it.

Disposal

Dispose of the control components in conformity with the applicable environmental regulations.

Disposal requires the control component to be disassembled and entirely taken apart.

- Treat the packaging as recyclable paper and cardboard.
- All metal components can be given to metal recycling.

Electronic scrap

Sort and dispose of electronic components by type. For details on proper disposal please check your national laws and regulations making sure that your method of disposal complies with them.

8 Programming

8.1 Firmware Update

To update the induction generator software, connect the generator to the MHS Controller and use the MHS Controller's SD card slot. Load new firmware from the SD card to all MHS induction generators connected to the MHS Controller.

Updating takes the following steps:

- ⇒ Rename the required software version to "**UPDATEGEN.hex**" and copy it to the SD card.
- ⇒ Insert the SD card in the Controller.
- ⇒ Supply power to the Controller and the generators (24 VDC Controller X1 Pin1; X1 Pin3).

The Controller's status LED will flash red while the unit is updating.

Afterwards, the Controller's status LED lights up green (OK) or red (error) for one second.

- ⇒ Shut off the 24V and remove the card.

Browse the SD card for a file called "UPDATEGEN.con", which contains details of the updating process:

```
Generator Loader Version 1.0.0.0
-----
Open File UPDATGEN.hex
-----
Update Generator Module 1
Update Generator Module 2
...
-----
Erase Flash Sector 1 (08008000)
Start flashing at: 08008000
Erase Flash Sector 2 (08010000)
Erase Flash Sector 3 (08018000)
Erase Flash Sector 4 (08020000)
Stop flashing at: 08035027
Program Flash success
```



NOTE

Use file "UPDATE.hex" for updating the Controller software.
You may find both files on the SD card.
Now update the Controller module first the generator module(s) second.



WARNING

Loading the wrong files or file versions may provoke an incorrect behaviour and/or damage the units.

- ⇒ *Do not install any updates without contacting Kendrion first.
Check with the contact person whether your hardware and software versions are compatible.*
- ⇒ *Mind to rename the correct file because the loader will otherwise load the wrong content.
Controller: **UPDATE.hex**
Output stage module: **UPDATGEN.hex***

9 Appendix

9.1 Insulation

Insulation of 24 VDC circuits from 400 VAC

The 24 VDC circuit is considered an accessible part which is insulated from the dangerous active 400 VAC part. Air gaps and creepage distances have been designed accordingly.

Insulation of housing from 400 VAC

The housing is considered an accessible earthed part which is insulated from the dangerous active 400 VAC part. Air gaps and creepage distances have been designed accordingly.

9.2 Dimensions

9.2.1 Housing Dimensions

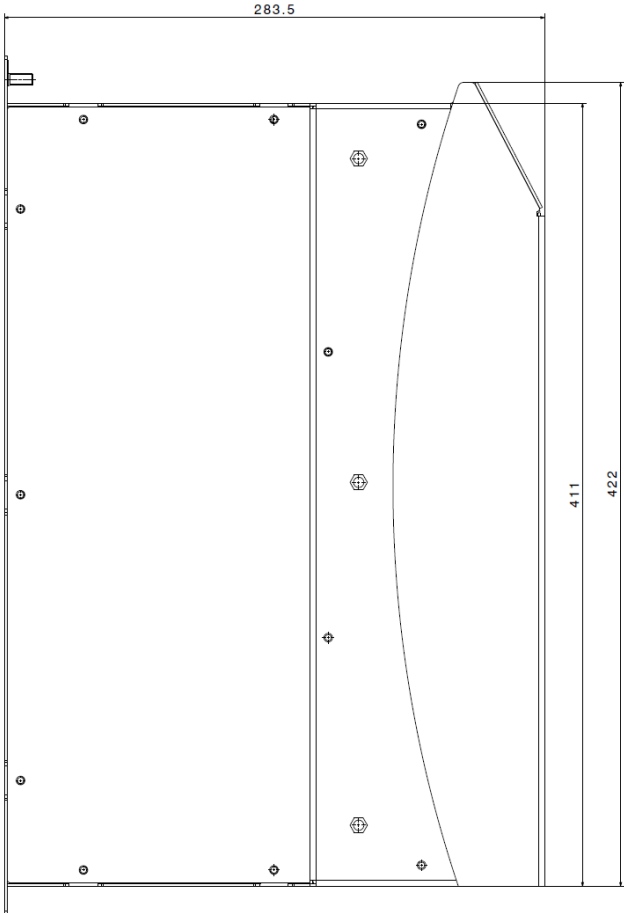
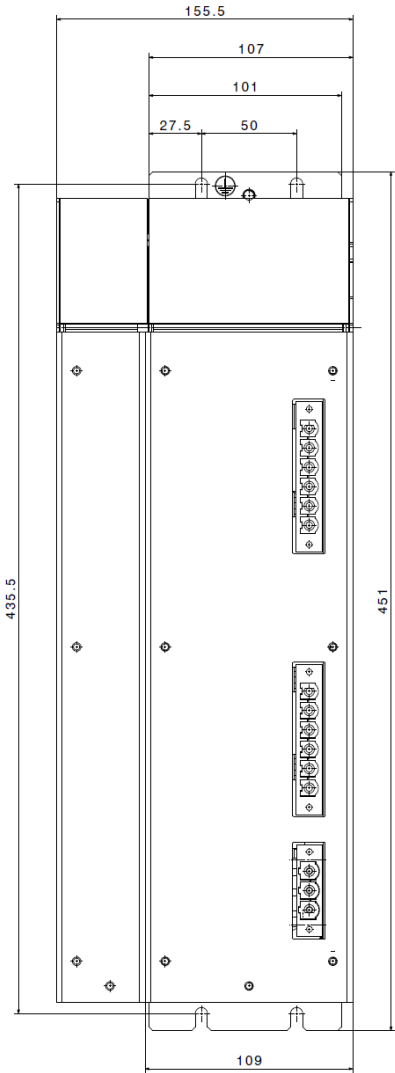

9.2.2 Mounting Dimensions

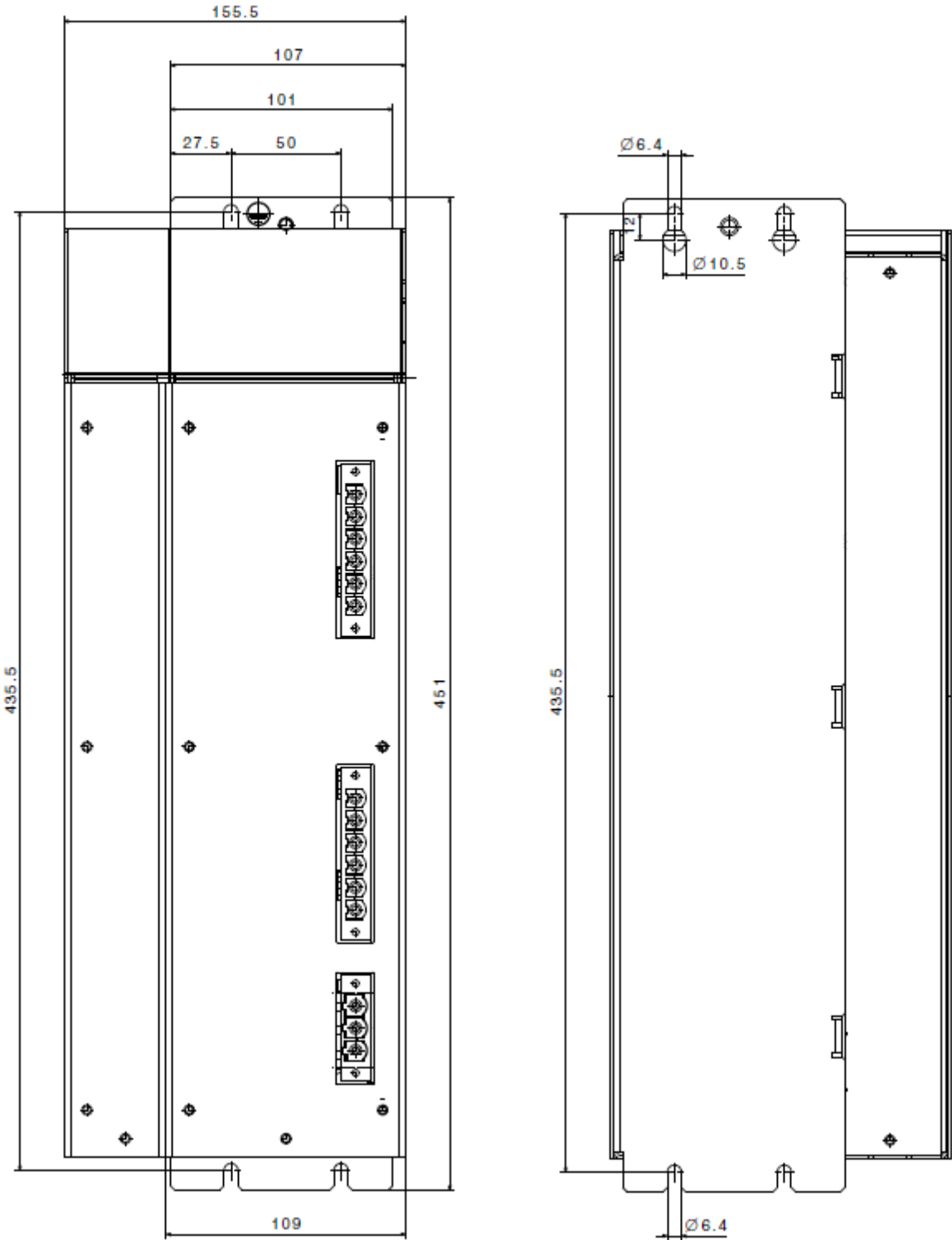

9.3 Certificates

9.4 Order Specifications

MHS Induction Generator 6 x 3 kW

610 660 00

6 x 3 kW, continuous rated output 18 kW

On-board performance measurement, short circuit detection, DC link voltage monitoring, automatic frequency adjustment, resonant frequency monitoring



MHS Induction Generator 4 x 7.5 kW

610 640 00

4 x 7.5 kW, 30 kW total capacity (peak), 26 kW continuous rated output

On-board performance measurement, short circuit detection, DC link voltage monitoring, automatic frequency adjustment, resonant frequency monitoring



9.4.1 Accessories

MHS PROFINET Controller

610 610 01

MHS IRT Controller

PROFINET IO Fieldbus

Temperature control, system monitoring, fieldbus communication, power output control, bus coupler for up to 7 MHS output stages, SD for software updates



MHS CANopen Controller

610 610 10

MHS CANopen Controller

EtherCAT Fieldbus

Temperature control, system monitoring, fieldbus communication, power output control, bus coupler for up to 7 MHS output stages, SD for software updates



MHS EtherCAT Controller

610 610 20

MHS ETH Controller

EtherCAT Fieldbus

Temperature control, system monitoring, fieldbus communication, power output control, bus coupler for up to 7 MHS output stages, SD for software updates



9.5 Sales & Service

Please visit us on the Internet to find a comprehensive overview of our sales and service network including all the relevant addresses. Feel free to also contact us at our headquarters in Malente/Germany:

9.5.1 Malente Headquarters

Kendrion Kuhnke Automation GmbH
Industrial Control Systems
Lütjenburger Straße 101
D-23714 Malente, Germany
Tel. +49 4523 402-0
Fax +49 4523 402-201
Email sales-ics@kendrion.com
Internet www.kendrion.com

Kendrion Kuhnke Automation GmbH
Industrial Control Systems

Lütjenburger Str. 101
D-23714 Malente

Tel.: +49 4523 402 0
Fax: +49 4523 402 201

sales-ics@kendrion.com
www.kendrion.com