

EtherCAT®

CANopen®

Kuhnke FIO I/O System

Product Manual: Counter Modules

12/03/2024

Table of Contents

- 1 Preface3
 - 1.1 Legal Notice.....3
 - 1.2 About this Manual.....3
- 2 Counter Modules4
 - 2.1 Generalities4
 - 2.1.1 Numeric Values4
 - 2.1.2 CoE – CANopen over EtherCAT4
 - 2.2 FIO Counter/Encoder (CoE).....5
 - 2.2.1 Function.....5
 - 2.2.2 Front View5
 - 2.2.3 Connectors (hardware rev. 2)5
 - 2.2.4 Status LEDs6
 - 2.2.5 Process Data Objects8
 - 2.2.6 Module Configuration9
 - 2.2.7 EtherCAT Configuration17
 - 2.2.8 Object Dictionary18
 - 2.2.9 Technical Data71
- 3 Appendix.....72
 - 3.1 Order Data.....72
 - 3.1.1 Modules.....72
 - 3.1.2 Accessories.....72

1 Preface

1.1 Legal Notice

Contact Details

Kendrion Kuhnke Automation GmbH
Industrial Control Systems
Lütjenburger Str. 101
D-23714 Malente
Germany

Support (phone) +49 4523 402-300
Support (email) controltechnology-ics@kendrion.com
Switchboard +49 4523 402-0
Sales (email) sales-ics@kendrion.com
Internet www.kendrion.com

Document History

Modification History

Date	Comments / Modifications
12.03.2024	New document structure created according to module groups

1.2 About this Manual

This technical information is primarily directed to system designers, project engineers and device developers. It does not contain any availability information. We reserve the rights for errors, omissions and modifications. Pictures are similar.

This product manual extends the system, installation and safe handling information provided by the Kuhnke FIO System Manual. This product manual only applies in conjunction with the system manual.

2 Counter Modules

2.1 Generalities

The range of analogue I/O modules comprises all Kuhnke FIO modules equipped with just analogue inputs, outputs or both inputs and outputs.

2.1.1 Numeric Values

As a general rule, numeric values are shown as decimals.

A prefixed 0x marks hexadecimal values (example: 0xFFFF).

A prefixed 0b marks binary values (example: 0b01010011).

Objects from the object dictionary generally show as hexadecimal value.

2.1.2 CoE – CANopen over EtherCAT

Communication protocol CANopen is based on CAN and designed to interconnect automation devices.

Communication profiles for various device classes harmonise device operations and simplify their handling.

EtherCAT features the same communication mechanisms as CANopen, i.e. an **object dictionary**, **process data objects (PDOs)** and **service data objects (SDOs)**, and a similar network management methodology.

The **object dictionary** describes the object available to the EtherCAT slave. It distinguishes between objects with read access (read), write access (write) and read/write access (read/write). The dictionary also classifies these objects as (mappable) process data objects, if so.

A cyclic process exchanges the **process data objects (PDOs)** and the input and output data they normally carry. Depending on your EtherCAT slave, you may be able to add (map) further object dictionary variables.

Service data objects (SDOs) provide options like setting the parameters of EtherCAT slaves and adding them to the startup parameters. They will then be automatically transferred to the EtherCAT slave as the EtherCAT bus starts up. Setting up the parameters is as easy as that. And if you have to replace your EtherCAT slave, you can simply use another EtherCAT slave of the same type.

2.2 FIO Counter/Encoder (CoE)

2.2.1 Function

The Counter/Encoder module has 2 counter/sensor interfaces for connecting incremental or absolute position encoders equipped with an SSI or EnDat interface. Using the event counter configuration option provides you with 6 independent event counters.

The interfaces configure almost independently, giving the module a maximum of flexibility.

2.2.2 Front View

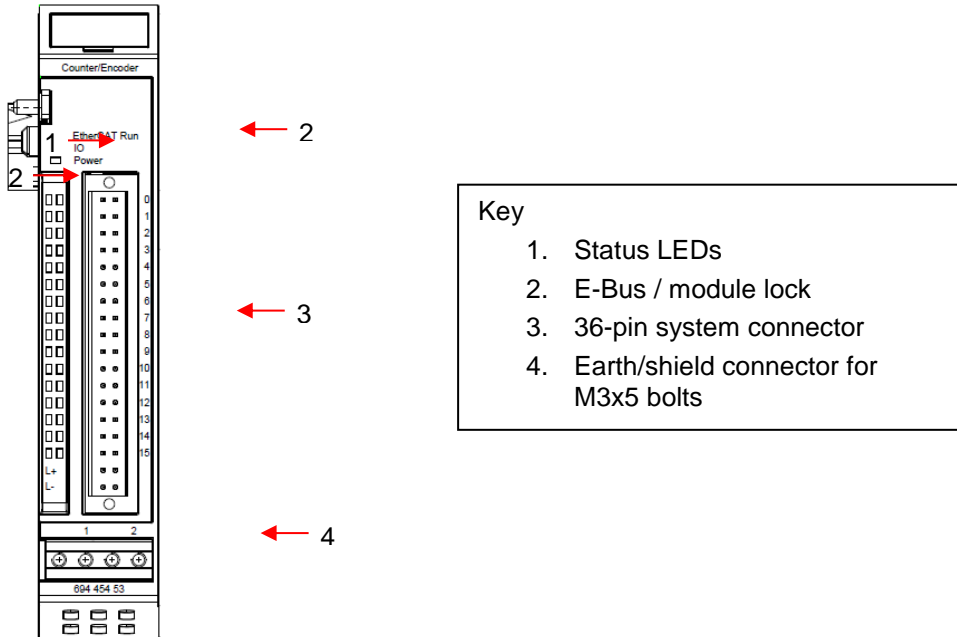

2.2.3 Connectors (hardware rev. 2)

I/O Power Supply (Load)

System connector pin 16: L+ 24 VDC
 System connector pin 17: L- 0 V

Digital Inputs

Left row of pins of system connector, pins 0, 2 (Enc 1)
 Right row of pins of system connector, pins 0, 2 (Enc 2)

Counter/Encoder Inputs

Left row of pins of system connector, pins 4... 11 (Enc 1)
 Right row of pins of system connector, pins 4... 11 (Enc 2)

EtherCAT

E-Bus IN female 10-pole connector
 E-Bus Out 10-pole multi-pin connector

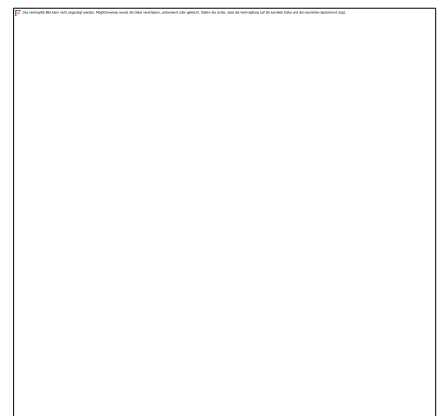

2.2.4 Status LEDs

LED "EtherCAT Run"

State	LED Flash Code	Explanation
Init	Off	Initialising, no data exchange
Pre-Op	Off/green, 1:1	Pre-operational, no data exchange
Safe-Op	Off/green, 5:1	Safe operation, inputs readable
Op	Green, on	Operational, unrestricted data exchange
Bootstrap	Flickering	Optional if the bootstrap mode is supported.

LED "IO"

State	LED Flash Code	Explanation
Ok	Green	No error
Error	Off	LED "EtherCAT Run" off: n/a LED "EtherCAT Run" green: Module defective
	Red, 2x	Low voltage
	Red, 3x	Internal watchdog
	Red, 4x	Bus error
	Red, 6x	Module-specific error, see Predefined Error Field 0x1003:01 ... 08 for details
	Red, 7x	Configuration error
	Red, on	Module defective

LED "Power"

State	LED	Explanation
On	Green	24 VDC supply to I/Os (load) ok
Off	Off	24 VDC supply not ok

LED "Channel"

Channel		Channel	Description
DI1		DI3	Digital input / capture input (rev. 2 or higher)
DI2		DI4	Digital input / reference input (rev. 2 or higher)
A+/CLK+		A+/CLK+	Incremental encoder: The LEDs indicate the signal state of the incremental encoder track
A-/CLK-		A-/CLK-	
B+/DAT+		B+/DAT+	Endat / SSI: The LEDs light up along with the Clock or Data signal
B-/DAT-		B-/DAT-	
Z+		Z+	Event counter: The LEDs indicate the signal state of the event counter input
Z-		Z-	

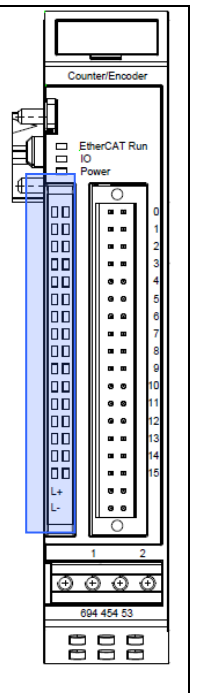

2.2.5 Process Data Objects

	Information
	<i>EtherCAT Modular Device Profile: Availability of process data objects depends on which modules are installed below the EtherCAT slave.</i>

General Process Data

Variable	Data Type	Explanation
Digital Input State	Byte	Logic level of digital inputs

Module-dependent Process Data Objects (Encoder)

Variable	Data Type	Explanation
Enc <n> Digital Interface Control	UINT	Controls the encoder interface (bit string)
Enc <n> DI Homeoffset Value SD	DINT	Reference position offset
Enc <n> Position Value	UDINT	Actual position
Enc <n> High Resolution Speed Value	DINT	Actual speed
Enc <n> DI Capture Value SD	DINT	Position at time of last capture signal (DI1, DI3)
Enc <n> Digital Interface Status	UINT	Encoder interface status (bit string)
Enc <n> Error Register	USINT	Error register (bit string)

Module-dependent Process Data Objects (Event Counter)

Variable	Data Type	Explanation
Enc 1 digital interface control	UINT	Controls the encoder interface (bit string)
Event counter channel 1	UDINT	Actual counter reading of event counter 1
Event counter channel 2	UDINT	Actual counter reading of event counter 2
Event counter channel 3	UDINT	Actual counter reading of event counter 3
Event counter channel 4	UDINT	Actual counter reading of event counter 4
Event counter channel 5	UDINT	Actual counter reading of event counter 5
Event counter channel 6	UDINT	Actual counter reading of event counter 6
Enc 1 error register	USINT	Error register (bit string)

2.2.6 Module Configuration

The counter/encoder interfaces are configured by plugging modules into the appropriate slots. A slot stands for a counter/encoder interface. A slot will accept the correct types of modules only. The procedure is based on the EtherCAT Modular Device Profile.

	Information
	<i>Check that there is a module in every slot.</i>

CODESYS devices explorer configuration example

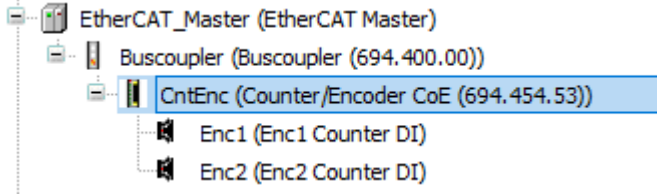

Configuration – Overview of Matching Modules (V1)

Slot	Slot Name	Function	Module Code	Module Function
1	Enc1	Encoder 1	192361013	Enc1 Counter
			192361014	Enc1 SSI
			192361015	Enc1 Endat
			192361016	Enc Event Counter
2	Enc2	Encoder 2	192361017	Enc2 Counter
			192361018	Enc2 SSI
			192361019	Enc2 Endat
			192361020	Enc event counter dummy module

Configuration – Overview of Matching Modules (V3)

Slot	Slot Name	Function	Module Code	Module Function
1	Enc1	Encoder 1	192362001	Enc1 Counter DI
			192362002	Enc1 SSI DI
			192362003	Enc1 Endat DI
			192361016	Enc Event Counter
			192362005	Enc1 SixStep DI
2	Enc2	Encoder 2	192362006	Enc2 Counter
			192362007	Enc2 SSI
			192362008	Enc2 Endat
			192361020	Enc event counter dummy module
			192362010	Enc2 SixStep DI

Encoder Interface

The general-purpose encoder interface provides you with many options of capturing angles, positions and counting pulses.

The system accepts the following encoders:

- Incremental encoder with RS422 interface (RS422)
- Incremental encoder with 5V single-ended interface (TTL)
- Incremental encoder with 24V single-ended interface (HTL)
- SixStep encoder with 5V single-ended interface (TTL)
- SixStep encoder with 24V single-ended interface (HTL)
- SSI encoder
- Endat 2.1 single-turn encoder
- Endat 2.1 multi-turn encoder

You can arrange them any way you like. The module also supplies max. 150 mA power to every 5V encoder. A power monitor outputs and error if this power rating is exceeded.

Another option is to use the encoder interface as an event counter for capturing 6 fast signals. If you do use this option, you cannot attach an encoder.

The sections below break down your configuration options and list the associated objects, which are linked to the object dictionary.

Encoder Interface Configuration – Incremental Encoder

Available objects

Slot	Object	Description
Enc1	0x2100, 0x2900 Enc<n> Digital Interface Type	64 Encoder (automatically assigned by the module)
Enc2		
Enc1	0x2103, 0x2903 Enc<n> Digital Interface Config	Sub 01 (level): 0=HTL, 1=TTL or 2=RS422 Sub 02 (mode): 0=multi-turn or 1=single-turn Sub 03 (index level): 0=reference on rising edge 1=reference on falling edge
Enc2		Sub 04 (SSI): 0=straight binary 1=Gray coded binary Sub 05 (event counter): 0=count rising edges 1=count falling edges 3=count both edges
Enc1	0x2110, 0x2910 Enc<n> Digital Interface Bit Size	Encoder resolution as per data sheet
Enc2		
Enc1	0x2111, 0x2911 Enc<n> Digital Interface Baud Rate	Clock frequency as per data sheet [kHz]
Enc2		
Enc1	0x6002, 0x6802 Enc<n> Total Measuring Range	Relevant for overflow in single-turn mode
Enc2		

Encoder Interface Configuration – SixStep Encoder

Available objects

Slot	Object	Description
Enc1	0x2100, 0x2900 Enc<n> Digital Interface Type	64 Encoder (automatically assigned by the module)
Enc2		
Enc1	0x2103, 0x2903 Enc<n> Digital Interface Config	Sub 01 (level): 0=HTL, 1=TTL or 2=RS422 Sub 02 (mode): 0=multi-turn or 1=single-turn Sub 03 (index level): 0=reference on rising edge 1=reference on falling edge
Enc2		Sub 04 (SSI): 0=straight binary 1=Gray coded binary Sub 05 (event counter): 0=count rising edges 1=count falling edges 3=count both edges
Enc1	0x2110, 0x2910 Enc<n> Digital Interface Bit Size	Encoder resolution as per data sheet
Enc2		
Enc1	0x2111, 0x2911 Enc<n> Digital Interface Baud Rate	Clock frequency as per data sheet [kHz]
Enc2		
Enc1	0x6002, 0x6802 Enc<n> Total Measuring Range	Relevant for overflow in single-turn mode
Enc2		

Encoder Interface Configuration – SSI Encoder

Available objects

Slot	Object	Description
Enc1	0x2100, 0x2900 Enc<n> Digital Interface Type	65 SSI (automatically assigned by the module)
Enc2		
Enc1	0x2103, 0x2903 Enc<n> Digital Interface Config	Sub 01 (level): 0=HTL, 1=TTL or 2=RS422 Sub 02 (mode): 0=multi-turn or 1=single-turn Sub 03 (index level): 0=reference on rising edge 1=reference on falling edge
Enc2		Sub 04 (SSI): 0=straight binary 1=Gray coded binary Sub 05 (event counter): 0=count rising edges 1=count falling edges 3=count both edges
Enc1	0x2110, 0x2910 Enc<n> Digital Interface Bit Size	Encoder resolution as per data sheet
Enc2		
Enc1	0x2111, 0x2911 Enc<n> Digital Interface Baud Rate	Clock frequency as per data sheet [kHz]
Enc2		
Enc1	0x6002, 0x6802 Enc<n> Total Measuring Range	Relevant for overflow in single-turn mode
Enc2		

Encoder Interface Configuration – ENDAT Encoder

Available objects

Slot	Object	Description
Enc1	0x2100, 0x2900 Enc<n> Digital Interface Type	69 Endat (automatically assigned by the module)
Enc2		
Enc1	0x2103, 0x2903 Enc<n> Digital Interface Config	Sub 01 (level): 0=HTL, 1=TTL or 2=RS422 Sub 02 (mode): 0=multi-turn or 1=single-turn Sub 03 (index level): 0=reference on rising edge 1=reference on falling edge Sub 04 (SSI): 0=straight binary 1=Gray coded binary Sub 05 (event counter): 0=count rising edges 1=count falling edges
Enc2		
Enc1	0x2110, 0x2910 Enc<n> Digital Interface Bit Size	Encoder resolution as per data sheet
Enc2		
Enc1	0x2111, 0x2911 Enc<n> Digital Interface Baud Rate	Clock frequency as per data sheet [kHz]
Enc2		
Enc1	0x6002, 0x6802 Enc<n> Total Measuring Range	Relevant for overflow in single-turn mode
Enc2		

Encoder Interface Configuration – Event Counter

Available objects

Slot	Object	Description
Enc1	0x2100, 0x2900 Enc<n> Digital Interface Type	80 Event Counter (automatically assigned by the module)
Enc2		Enc event counter dummy module
Enc1	0x2103, 0x2903 Enc<n> Digital Interface Config	Sub 01 (level): 0=HTL, 1=TTL or 2=RS422 Sub 02 (mode): 0=multi-turn or 1=single-turn Sub 03 (index level): 0=reference on rising edge 1=reference on falling edge
Enc2		Sub 04 (SSI): 0=straight binary 1=Gray coded binary Sub 05 (event counter): 0=count rising edges 1=count falling edges 3=count both edges
Enc1	0x2110, 0x2910 Enc<n> Digital Interface Bit Size	Encoder resolution as per data sheet
Enc2		
Enc1	0x2111, 0x2911 Enc<n> Digital Interface Baud Rate	Clock frequency as per data sheet [kHz]
Enc2		
Enc1	0x6002, 0x6802 Enc<n> Total Measuring Range	Relevant for overflow in single-turn mode
Enc2		

**Information**

The event counter inputs cannot be used for mechanical switches because they are neither debounced nor filtered.

**Information**

*The max. counting frequency of event counter channels 0 & 3 is 400 kHz.
The max. counting frequency of event counter channels 1, 2, 4 & 5 is 5 kHz.*

**Information**

Only the event counter dummy module may be in slot 2 if you wish to use the module as an event counter. Also operating an encoder is currently not supported.

Encoder Interface Configuration – User-defined Units

Apart from position values in increments, the module can also output the position value in user-defined units (in REAL format). This option applies to incremental, SSI and ENDAT encoders.

The following objects are available for outputting the position value in user-defined units:

- 0x2014, 0x2814 Enc<n> Linear Position Value
- 0x2031, 0x2831 Enc<n> Linear Speed Value

Add these objects to the PDO mapping as needed.

To calculate the position value:

$$\text{Linear Position Value} = \text{High Resolution Raw Value} * \frac{\text{Encoder Increments}}{\text{Motor Revolutions}} * \frac{\text{Motor Shaft Revolutions}}{\text{Driving Shaft Revolutions}} * \frac{\text{Feed}}{\text{Shaft Revolutions}}$$

Available objects

Slot	Object	Description
Enc1	0x208f, 0x288f Enc<n> Position Encoder Resolution	$\frac{\text{Encoder Increments}}{\text{Motor Revolutions}}$
Enc2		
Enc1	0x2091, 0x2891 Enc<n> Gear Ratio	$\frac{\text{Motor Shaft Revolutions}}{\text{Driving Shaft Revolutions}}$
Enc2		
Enc1	0x2092, 0x2892 Enc<n> Feed Constant	$\frac{\text{Feed}}{\text{Shaft Revolutions}}$
Enc2		

Digital Input Configuration

Prerequisites:

- ➔ Hardware rev. 2
- ➔ Software release 2.00 or higher

Proceed as follows to configure the 4 digital inputs of the FIO counter/encoder module:

0x3000 Digital Input Function Select – SubIndex 01...04

- **0 Digital Input (Default)**
The inputs configured as "digital inputs" respond just like ordinary PLC inputs. Use object 0x3002 to configure the filter time of the input in question. Object 0x3050 (Digital Input State) shows the state of the digital inputs and is contained in the default PDO mapping already.
- **1 Special Function Enable**
The Special Function the inputs may be set to are related to the encoder interface. Use objects 0x3001 to choose which edge will trigger the special function. Then use object 0x3002 to set the filter time. Best practice is to set a special-function input to "0 - no filter / special function is edge triggered".
 - SubIndex 01: Capture input for encoder 1
 - SubIndex 02: Reference input for encoder 1
 - Subindex 03: Capture input for encoder 2
 - Subindex 04: Reference input for encoder 2
- **2 Timestamp Function (Subindexes 01 & 02)**
The timestamp function starts measuring the difference in time between two subsequent input signals sent to DI1 and DI2. The output is made to object 0x3060 / 0x3061. The function also counts the input signals (<=4kHz). Counter readings are output to object 0x3070 / 0x3071.

0x3001 Digital Input Edge Sensitivity Select – Subindex 01...04

- **1 rising edge (default)**
- 2 falling edge
- 3 both edges

0x3002 Digital Input Filter Select – Subindex 01...04

- 0 no filter / special function is edge triggered
- 1 0.3ms filter
- **2 1.0ms filter (default)**
- 3 3.0ms filter
- 4 5.0ms filter
- 5 10ms filter
- 6 20ms filter



Information

The inputs cannot be used for mechanical switches because they are not filtered by the configuration.

Encoder Referencing

The FIO counter/encoder module knows various ways of how to reference the position value.

Reference Position Found by Digital Input

Enable the Special Function of the required reference input, see section Digital Input Configuration. Now enable referencing by setting bit 2 (REF DI) of object Enc<n> Digital Interface Control (Enc1 0x2101 bzw. Enc2 0x2801). When a rising edge is detected at the reference input, the current position value is set to Enc<n> Preset Value Signed or Enc<n> High Resolution Preset Value Signed. Absolute value encoders save this value as a remanent value in the module. Bit 7 (Referenced DI) of Enc<n> Digital Interface Status acknowledges that referencing has been successful.

Reset by the Application

	Information
	<i>This function is available for A/B/Ref counter or SixStep encoders only</i>

Setting bit 4 (RES CNT) of object Enc<n> Digital Interface Control (Enc1 0x2101 or Enc2 0x2801) sets the current position value to Enc<n> Preset Value Signed or Enc<n> High Resolution Preset Value Signed.

Factor Group

Use the factor group to convert the encoder's position value to user-defined units.

The following equation calculates the ratio of user-defined and internal (encoder) values (example encoder 1):

$$\text{linear position value } 0x2014:00 = \frac{\text{position value } 0x6005 * \text{feed constant } 0x2092}{\text{position encoder resolution } 0x208f * \text{gear ratio } 0x2091}$$

Objects for calculating the user-defined units (example encoder 1):

$$\text{position encoder resolution } 0x208f = \frac{\text{Encoder Increments } 0x208f:01}{\text{Motor Revolution } 0x208f:02}$$

$$\text{gear ratio } 0x2091 = \frac{\text{Motor Shaft Revolutions } 0x2091:01}{\text{Driving Shaft Revolutions } 0x2091:02}$$

$$\text{feed constant } 0x2092 = \frac{\text{Feed } 0x2092:01}{\text{Shaft Revolutions } 0x2092:02}$$

2.2.7 EtherCAT Configuration

The module supports two op modes

Mode: Synchronous Syncmanager

The cycling EtherCAT frame triggers data exchange with the bus.

Mode: Distributed Clocks

All EtherCAT network stations should use synchronised clocks, if they are to capture and output data at the same point in time. This is achieved by a local clock in every EtherCAT slave controller that the EtherCAT master automatically synchronises with the EtherCAT network's master clock.

The EtherCAT slave controllers residing in the EtherCAT network generate synchronous interrupts which simultaneously capture input data and/or process output data.

2.2.8 Object Dictionary

0x1000 Device Type

Object Code	Variable
-------------	----------

SUB	0x00
Name	Device type
Data type	UNSIGNED32
Access	R/O
Default value	5001 (0x1389)
PDO mapping	No

5001 = Modular Device Profile

0x1001 Error Register

Object Code	Variable
-------------	----------

Sub	0x00
Name	Error register
Data type	UNSIGNED8
Access	R/O
Default value	
PDO mapping	No

In case of an error, the associated error bit is set. The bit is cleared automatically when the cause of the error has been removed.

This object OR-links the following objects:

0x2001 Enc1 Error Register

0x2801 Enc2 Error Register

7	6	5	4	3	2	1	0
MAN	RES	PROF	COM	TEMP	VOL	CUR	GEN

GEN: general error

CUR: current

VOL: voltage

TEMP: temperature

COM: communication

PROF: device profile

RES: not used, always "0"

MAN: manufacturer-specific

0x1003 Pre-defined Error Field

Object Code	Array
-------------	-------

Sub	0x00
Name	Highest sub-index supported
Data type	UNSIGNED8
Access	RW
Default value	8
Low limit	0
High limit	0
PDO mapping	No

Sub	0x01
Name	Standard error field 1
Data type	UNSIGNED32
Access	R/O
Default value	
PDO mapping	No
Access name	Pre-definederrorfield[0]

Sub	0x02
Name	Standard error field 2
Data type	UNSIGNED32
Access	R/O
Default value	
PDO mapping	No
Access name	Pre-definederrorfield[1]

Sub	0x03
Name	Standard error field 3
Data type	UNSIGNED32
Access	R/O
Default value	
PDO mapping	No
Access name	Pre-definederrorfield[2]

Sub	0x04
Name	Standard error field 4
Data type	UNSIGNED32
Access	R/O
Default value	
PDO mapping	No
Access name	Pre-definederrorfield[3]

Sub	0x05
Name	Standard error field 5
Data type	UNSIGNED32
Access	R/O
Default value	
PDO mapping	No
Access name	Pre-definederrorfield[4]

Sub	0x06
Name	Standard error field 6
Data type	UNSIGNED32
Access	R/O
Default value	
PDO mapping	No
Access name	Pre-definederrorfield[5]

Sub	0x07
Name	Standard error field 7
Data type	UNSIGNED32
Access	R/O
Default value	
PDO mapping	No
Access name	Pre-definederrorfield[6]

Sub	0x08
Name	Standard error field 8
Data type	UNSIGNED32
Access	R/O
Default value	
PDO mapping	No
Access name	Pre-definederrorfield[7]

A new error occurring is entered in subindex 1. Previous entries in subindices 1 to 7 are moved one place back. The error in subindex 7 is removed.

Check the object with subindex 0 to find the number of previous errors. Setting this object to "0" starts a new count.

Bit															
31	30	29	28	27	26	25	24	23	22	21	20	19	18	17	16
Error Register								Error Origin				Sub-Number			
15	14	13	12	11	10	9	8	7	6	5	4	3	2	1	0
Error Code															

Error Register [31 ... 24]

Copy of object 0x1001 after causing an error

Error Origin [23 ... 20]

Source of error inside the device

0xF across module / logical device

0x1 encoder 1

0x2 encoder 2

0x3 AI/AO

Sub-Number [19 ... 16]

See Error Code table

Error Code [15 ... 0]

Error Code	Sub	Device	Channel	Reaction	Explanation
0x2110	0x0	Enc1/Enc2		None	Encoder supply overload
0x3100	0x0	Module		None	Low module voltage
0x3110	0x1	Enc1/Enc2		None	Signal integrity error
0x6100	0x0	Module		Device no longer operational	Watchdog
0x7000	0x0	Enc1/Enc2		None	Endat CRC error
0x7000	0x1	Enc1/Enc2		None	Endat encoder error
0x7000	0x2	Enc1/Enc2		None	Endat timeout/answer format
0x7000	0x3	Enc1/Enc2		None	SixStep encoder error: - Illegal input bit pattern - Step width <> 1
0x8100	0x0	Module		Device no longer operational	Communication error

0x1008 Manufacturer Device Name

Object Code	Variable
-------------	----------

Sub	0x00
Name	Manufacturer device name
Data type	VISIBLE_STRING
Access	R/O
Default value	Counter/encoder (694.454.53)
PDO mapping	No

0x1009 Manufacturer Hardware Version

Object Code	Variable
-------------	----------

Sub	0x00
Name	Manufacturer hardware version
Data type	VISIBLE_STRING
Access	R/O
Default value	1.00
PDO mapping	No

0x100a Manufacturer Software Version

Object Code	Variable
-------------	----------

Sub	0x00
Name	Manufacturer software version
Data type	VISIBLE_STRING
Access	R/O
Default value	C017
PDO mapping	No

0x1010 Store Parameters

Object Code	Array
-------------	-------

Sub	0x00
Name	Highest sub-index supported
Data type	UNSIGNED8
Access	R/O
Default value	5
PDO mapping	No

Sub	0x01
Name	Save all parameters
Data type	UNSIGNED32
Access	R/W
Default value	
PDO mapping	No
Access name	Storeparameters[0]

Sub	0x02
Name	Save communication parameters
Data type	UNSIGNED32
Access	R/W
Default value	
PDO mapping	No
Access name	Storeparameters[1]

Sub	0x03
Name	Save application parameters
Data type	UNSIGNED32
Access	R/W
Default value	
PDO mapping	No
Access name	Storeparameters[2]

Sub	0x04
Name	Save Enc1 parameters
Data type	UNSIGNED32
Access	R/W
Default value	
PDO mapping	No
Access name	Storeparameters[3]

Sub	0x05
Name	Save Enc2 parameters
Data type	UNSIGNED32
Access	R/W
Default value	
PDO mapping	No
Access name	Storeparameters[4]

Entering 65766173h (ASCII "save") in subindex 01h ... 05h starts the saving process

Subindex 01: Saves all parameters (Enc1 and Enc2)

Subindex 02: No function assigned, available for normative reasons

Subindex 03: Saves all application parameters (Enc1 and Enc2)

Subindex 04: Saves the parameters of Enc1

Subindex 05: Saves the parameters of Enc2

The process saves both the on-board reference position and a reference flag. If running absolute value encoders, re-referencing is not necessary after switching on. Saving is automatically starting if you are using absolute value encoders.

0x1011 Restore Default Parameters

Object Code	Array
-------------	-------

Sub	0x00
Name	Highest sub-index supported
Data type	UNSIGNED8
Access	R/O
Default value	5
PDO mapping	No

Sub	0x01
Name	Restore all default parameters
Data type	UNSIGNED32
Access	R/W
Default value	
PDO mapping	No
Access name	Restoredefaultparameters[0]

Sub	0x02
Name	Restore communication default parameters
Data type	UNSIGNED32
Access	R/W
Default value	
PDO mapping	No
Access name	Restoredefaultparameters[1]

Sub	0x03
Name	Restore application default parameters
Data type	UNSIGNED32
Access	R/W
Default value	
PDO mapping	No
Access name	Restoredefaultparameters[2]

Sub	0x04
Name	Restore Enc1 default parameters
Data type	UNSIGNED32
Access	R/W
Default value	
PDO mapping	No
Access name	Restoredefaultparameters[3]

Sub	0x05
Name	Restore Enc2 default parameters
Data type	UNSIGNED32
Access	R/W
Default value	
PDO mapping	No
Access name	Restoredefaultparameters[4]

Entering 64616F6Ch (ASCII "load") in subindex 01h ... 05h starts the associated restoring process.

Subindex 01: Clears all parameters (Enc1 and Enc2)

Subindex 02: No function assigned, available for normative reasons

Subindex 03: Clears all application parameters (Enc1 and Enc2)

Subindex 04: Clears the parameters of Enc1

Subindex 05: Clears the parameters of Enc2

0x1018 Identity Object

Object Code	Record
-------------	--------

Sub	0x00
Name	Highest sub-index supported
Data type	UNSIGNED8
Access	R/O
Default value	0x04
PDO mapping	No

Sub	0x01
Name	Vendor ID
Data type	UNSIGNED32
Access	R/O
Default value	0x48554B
PDO mapping	No

Sub	0x02
Name	Product code
Data type	UNSIGNED32
Access	R/O
Default value	0x2EF6A
PDO mapping	No

Sub	0x03
Name	Revision number
Data type	UNSIGNED32
Access	R/O
Default value	0x00000001
PDO mapping	No

Sub	0x04
Name	Serial number
Data type	UNSIGNED32
Access	R/O
Default value	0x00000000
PDO mapping	No

0x10f1 Error Settings

Object Code	Record
-------------	--------

Sub	0x00
Name	Highest sub-index supported
Data type	UNSIGNED8
Access	R/O
Default value	2
PDO mapping	No

Sub	0x01
Name	Local error reaction
Data type	UNSIGNED32
Access	R/W
Default value	1
PDO mapping	No

Sub	0x02
Name	Sync error counter limit
Data type	UNSIGNED16
Access	R/W
Default value	4
PDO mapping	No

0x10f8 Timestamp Object

Object Code	Variable
-------------	----------

Sub	0x00
Name	Timestamp object
Data type	UNSIGNED64
Access	R/W
Default value	
PDO mapping	Optional, TPDO only

0x1601 Digital Interface Control Encoder 1

Object Code	Record
-------------	--------

Sub	0x00
Name	SubIndex 000
Data type	UNSIGNED8
Access	R/O
Default value	2
Low limit	0
High limit	8
PDO mapping	No

Sub	0x01
Name	Mapping entry 1
Data type	UNSIGNED32
Access	R/O
Default value	0x21010010
PDO mapping	No

Sub	0x02
Name	Mapping entry 2
Data type	UNSIGNED32
Access	R/O
Default value	0x32000020
PDO mapping	No

A subindex (1-8) describes exactly one mapped object. A mapping entry contains four bytes which are made up as follows:

Index[16]	bits 31..16	index of object to be mapped
SubIndex[8]	bits 15..8	subindex of object to be mapped
Length[8]	bits 7..0	length of object to be mapped

0x1602 Digital Interface Control Encoder 2

Sub	0x00
Name	SubIndex 000
Data type	UNSIGNED8
Access	R/O
Default value	2
Low limit	0
High limit	8
PDO mapping	No

Sub	0x01
Name	Mapping entry 1
Data type	UNSIGNED32
Access	R/O
Default value	0x29010010
PDO mapping	No

Sub	0x02
Name	Mapping entry 2
Data type	UNSIGNED32
Access	R/O
Default value	0x3a000020
PDO mapping	No

A subindex (1-8) describes exactly one mapped object. A mapping entry contains four bytes which are made up as follows:

Index[16]	bits 31..16	index of object to be mapped
SubIndex[8]	bits 15..8	subindex of object to be mapped
Length[8]	bits 7..0	length of object to be mapped

0x1a00 Counter / Encoder Device

Object Code	Record
-------------	--------

Sub	0x00
Name	SubIndex 000
Data type	UNSIGNED8
Access	R/O
Default value	1
Low limit	0
High limit	8
PDO mapping	No

Sub	0x01
Name	Mapping entry 1
Data type	UNSIGNED32
Access	R/O
Default value	0x30500008
PDO mapping	No

A subindex (1-8) describes exactly one mapped object. A mapping entry contains four bytes which are made up as follows:

Index[16]	bits 31..16	index of object to be mapped
SubIndex[8]	bits 15..8	subindex of object to be mapped
Length[8]	bits 7..0	length of object to be mapped

0x1a05 Rotary Encoder SD Encoder 1

Object Code	Record
-------------	--------

Sub	0x00
Name	SubIndex 000
Data type	UNSIGNED8
Access	R/O
Default value	4
Low limit	0
High limit	8
PDO mapping	No

Sub	0x01
Name	Mapping entry 1
Data type	UNSIGNED32
Access	R/O
Default value	0x60040020
PDO mapping	No

Sub	0x02
Name	Mapping entry 2
Data type	UNSIGNED32
Access	R/O
Default value	0x20300020
PDO mapping	No

Sub	0x03
Name	Mapping entry 3
Data type	UNSIGNED32
Access	R/O
Default value	0x31000020
PDO mapping	No

Sub	0x04
Name	Mapping entry 4
Data type	UNSIGNED32
Access	R/O
Default value	0x20010008
PDO mapping	No

A subindex (1-8) describes exactly one mapped object. A mapping entry contains four bytes which are made up as follows:

Index[16]	bits 31..16	index of object to be mapped
SubIndex[8]	bits 15..8	subindex of object to be mapped
Length[8]	bits 7..0	length of object to be mapped

0x1a06 Event Counter

Object Code	Record
-------------	--------

Sub	0x00
Name	SubIndex 000
Data type	UNSIGNED8
Access	R/O
Default value	6
Low limit	0
High limit	8
PDO mapping	No

Sub	0x01
Name	Mapping entry 1
Data type	UNSIGNED32
Access	R/O
Default value	0x24080120
PDO mapping	No

Sub	0x02
Name	Mapping entry 2
Data type	UNSIGNED32
Access	R/O
Default value	0x24080220
PDO mapping	No

Sub	0x03
Name	Mapping entry 3
Data type	UNSIGNED32
Access	R/O
Default value	0x24080320
PDO mapping	No

Sub	0x04
Name	Mapping entry 4
Data type	UNSIGNED32
Access	R/O
Default value	0x24080420
PDO mapping	No

Sub	0x05
-----	------

Name	Mapping entry 5
Data type	UNSIGNED32
Access	R/O
Default value	0x24080520
PDO mapping	No

Sub	0x06
Name	Mapping entry 6
Data type	UNSIGNED32
Access	R/O
Default value	0x24080620
PDO mapping	No

A subindex (1-8) describes exactly one mapped object. A mapping entry contains four bytes which are made up as follows:

Index[16]	bits 31..16	index of object to be mapped
SubIndex[8]	bits 15..8	subindex of object to be mapped
Length[8]	bits 7..0	length of object to be mapped

0x1a07 Rotary Encoder SD Encoder 2

Object Code	Record
-------------	--------

Sub	0x00
Name	SubIndex 000
Data type	UNSIGNED8
Access	R/O
Default value	4
Low limit	0
High limit	8
PDO mapping	No

Sub	0x01
Name	Mapping entry 1
Data type	UNSIGNED32
Access	R/O
Default value	0x68040020
PDO mapping	No

Sub	0x02
Name	Mapping entry 2
Data type	UNSIGNED32
Access	R/O
Default value	0x28300020
PDO mapping	No

Sub	0x03
Name	Mapping entry 3
Data type	UNSIGNED32
Access	R/O
Default value	0x39000020
PDO mapping	No

Sub	0x04
Name	Mapping entry 4
Data type	UNSIGNED32
Access	R/O
Default value	0x28010008
PDO mapping	No

A subindex (1-8) describes exactly one mapped object. A mapping entry contains four bytes which are made up as follows:

Index[16]	bits 31..16	index of object to be mapped
SubIndex[8]	bits 15..8	subindex of object to be mapped
Length[8]	bits 7..0	length of object to be mapped

0x1c00 Sync Manager Communication Type

Object Code	Array
-------------	-------

Sub	0x00
Name	Highest subindex supported
Data type	UNSIGNED8
Access	R/O
Default value	4
Low limit	0
High limit	8
PDO mapping	No

Sub	0x01
Name	SubIndex 1
Data type	UNSIGNED8
Access	R/O
Default value	1
PDO mapping	No

Sub	0x02
Name	SubIndex 2
Data type	UNSIGNED8
Access	R/O
Default value	2
PDO mapping	No

Sub	0x03
Name	SubIndex 3
Data type	UNSIGNED8
Access	R/O
Default value	3
PDO mapping	No

Sub	0x04
Name	SubIndex 4
Data type	UNSIGNED8
Access	R/O
Default value	4
PDO mapping	No

0x1c12 Sync Manager 2 PDO Assignment

Object Code	Array
-------------	-------

Sub	0x00
Name	Highest subindex supported
Data type	UNSIGNED8
Access	R/O
Default value	2
Low limit	0
High limit	2
PDO mapping	No
Access	R/O

0x1c13 Sync Manager 3 PDO Assignment

Object Code	Array
-------------	-------

Sub	0x00
Name	Highest subindex supported
Data type	UNSIGNED8
Access	R/W
Default value	1
Low limit	0
High limit	4
PDO mapping	No

Sub	0x01
Name	Subindex
Data type	UNSIGNED16
Access	R/O
Default value	0x1a00
PDO mapping	No

0x1c32 Sync Manager 2 Synchronization

Object Code	Record
-------------	--------

Sub	0x00
Name	Highest subindex supported
Data type	UNSIGNED8
Access	R/O
Default value	32
Low limit	0
High limit	8
PDO mapping	No

Sub	0x01
Name	Synchronization type
Data type	UNSIGNED16
Access	R/O
Default value	0x10
PDO mapping	No

Sub	0x02
Name	Cycle Time
Data type	UNSIGNED32
Access	R/O
Default value	0x20
PDO mapping	No

Sub	0x04
Name	Synchronization types supported
Data type	UNSIGNED16
Access	R/O
Default value	0x10
PDO mapping	No

Sub	0x05
Name	Cycle time
Data type	UNSIGNED32
Access	R/O
Default value	0x20
PDO mapping	No

Sub	0x06
Name	Calc and copy time
Data type	UNSIGNED32
Access	R/O
Default value	0x20
PDO mapping	No

Sub	0x08
Name	Cycle time
Data type	UNSIGNED16
Access	R/W
Default value	0x10
PDO mapping	No

Sub	0x09
Name	Delay time
Data type	UNSIGNED32
Access	R/O
Default value	0x20
PDO mapping	No

Sub	0x0a
Name	Sync0 cycle time
Data type	UNSIGNED32
Access	R/W
Default value	0x20
PDO mapping	No

Sub	0x0b
Name	SM event missed
Data type	UNSIGNED16
Access	R/O
Default value	0x10
PDO mapping	No

Sub	0x0c
Name	Cycle time too small
Data type	UNSIGNED16
Access	R/O
Default value	0x10
PDO mapping	No

Sub	0x20
-----	------

Name	Sync error
Data type	BOOLEAN
Access	R/O
Default value	0x01
PDO mapping	No

0x1c33 Sync Manager 3 Synchronization

Object Code	Record
-------------	--------

Sub	0x00
Name	Highest subindex supported
Data type	UNSIGNED8
Access	R/O
Default value	32
Low limit	0
High limit	8
PDO mapping	No

Sub	0x01
Name	Synchronization type
Data type	UNSIGNED16
Access	R/O
Default value	0x10
PDO mapping	No

Sub	0x02
Name	Cycle time
Data type	UNSIGNED32
Access	R/O
Default value	0x20
PDO mapping	No

Sub	0x04
Name	Synchronization types supported
Data type	UNSIGNED16
Access	R/O
Default value	0x10
PDO mapping	No

Sub	0x05
Name	Cycle time
Data type	UNSIGNED32
Access	R/O
Default value	0x20
PDO mapping	No

Sub	0x06
-----	------

Name	Calc and copy time
Data type	UNSIGNED32
Access	R/O
Default value	0x20
PDO mapping	No

Sub	0x08
Name	Cycle time
Data type	UNSIGNED16
Access	R/W
Default value	0x20
PDO mapping	No

Sub	0x09
Name	Delay time
Data type	UNSIGNED32
Access	R/O
Default value	0x10
PDO mapping	No

Sub	0x0a
Name	Sync0 cycle time
Data type	UNSIGNED32
Access	R/W
Default value	0x20
PDO mapping	No

Sub	0x0b
Name	SM event missed
Data type	UNSIGNED16
Access	R/O
Default value	0x20
PDO mapping	No

Sub	0x0c
Name	Cycle time too small
Data type	UNSIGNED16
Access	R/O
Default value	0x10
PDO mapping	No

Sub	0x20
Name	Sync error

Data type	BOOLEAN
Access	R/O
Default value	0x01
PDO mapping	No

0x2001, 0x2801 Enc<n> Error Register

Object Code	Variable
-------------	----------

Sub	0x00
Name	Enc1 error register
Data type	UNSIGNED8
Access	R/O
Default value	
PDO mapping	Optional, TPDO only
Access name	Enc1ErrorRegister

See object 0x1001 Error Register

0x2003, 0x2803 Enc<n> Preset Value Signed

Object Code	Variable
-------------	----------

Sub	0x00
Name	Enc1 preset value signed
Data type	INTEGER32
Access	R/W
Default value	
PDO mapping	No
Access name	Enc1PresetValueSigned

A/B/Ref or Six-Step encoder only: preset value used when resetting the encoder.

0x2004, 0x2804 Enc<n> Position Value Signed

Object Code	Variable
-------------	----------

Sub	0x00
Name	Enc1 position value signed
Data type	INTEGER32
Access	R/O
Default value	
PDO mapping	Optional, TPDO only
Access name	Enc1PositionValueSigned

0x2008, 0x2808 Enc<n> High Resolution Position Value Signed

Object Code	Variable
-------------	----------

Sub	0x00
Name	Enc1 high resolution position value signed
Data type	INTEGER64
Access	R/O
Default value	
PDO mapping	Optional, TPDO only
Access name	Enc1HighResolutionPositionValueSigned

0x2009, 0x2809 Enc<n> High Resolution Preset Value Signed

Object Code	Variable
-------------	----------

Sub	0x00
Name	Enc1 high resolution preset value signed
Data type	INTEGER64
Access	R/W
Default value	
PDO mapping	No
Access name	Enc1HighResolutionPresetValueSigned

A/B/Ref or Six-Step encoder only: preset value used when resetting the encoder.

0x2014, 0x2814 Enc<n> Linear Position Value

Object Code	Variable
-------------	----------

Sub	0x00
Name	Enc1 linear position value
Data type	REAL32
Access	R/O
Default value	
PDO mapping	Optional, TPDO only
Access name	Enc1LinearPositionValue

Position value in user-defined units

0x2015, 0x2815 Enc<n> Linear Position Preset Value

Object Code	Variable
-------------	----------

Sub	0x00
Name	Enc1 linear position preset value
Data type	REAL32
Access	R/W
Default value	
PDO mapping	No
Access name	Enc1LinearPositionPresetValue

Position offset in user-defined units

0x2030, 0x2830 Enc<n> High Resolution Speed Value

Object Code	Variable
-------------	----------

Sub	0x00
Name	Enc1 high resolution speed value
Data type	INTEGER32
Access	R/O
Default value	
PDO mapping	Optional, TPDO only
Access name	Enc1HighResolutionSpeedValue

Speed value

0x2031, 0x2831 Enc<n> Linear Speed Value

Object Code	Variable
-------------	----------

Sub	0x00
Name	Enc1 linear speed value
Data type	REAL32
Access	R/O
Default value	
PDO mapping	Optional, TPDO only
Access name	Enc1LinearSpeedValue

Speed value in user-defined units

0x2032, 0x2832 Enc<n> Speed Value Filter Select

Object Code	Variable
Sub	0x00
Name	Enc1 speed value filter select
Data type	unknown
Access	R/O
Default value	11
PDO mapping	No
Access name	Enc1SpeedValueFilterSelect

Configuration object for calculating the speed

0 no filter

10 PT1 filter

11 integration (default)

0x208f, 0x288f Enc<n> Position Encoder Resolution

Object Code	Record
-------------	--------

Sub	0x00
Name	SubIndex 000
Data type	UNSIGNED8
Access	R/O
Default value	2
PDO mapping	No

Sub	0x01
Name	Encoder increments
Data type	UNSIGNED32
Access	R/W
Default value	0x000003E8
PDO mapping	No
Access name	Enc1PositionEncoderResolution.EncoderIncrements

Sub	0x02
Name	Motor revolutions
Data type	UNSIGNED32
Access	R/W
Default value	0x00000001
PDO mapping	No
Access name	Enc1PositionEncoderResolution.MotorRevolutions

To convert the units:

$$\frac{\text{Encoder Increments } 208f:01}{\text{Motor Revolution } 208f:02}$$

0x2091, 0x2891 Enc<n> Gear Ratio

Object Code	Record
-------------	--------

Sub	0x00
Name	SubIndex 000
Data type	UNSIGNED8
Access	Ro0
Default value	2
PDO mapping	No

Sub	0x01
Name	Motor shaft revolutions
Data type	UNSIGNED32
Access	R/W
Default value	0x00000001
PDO mapping	No
Access name	Enc1GearRatio.MotorShaftRevolutions

Sub	0x02
Name	Driving shaft revolutions
Data type	UNSIGNED32
Access	R/W
Default value	0x00000001
PDO mapping	No
Access name	Enc1GearRatio.DrivingShaftRevolutions

To convert the units:

$$\frac{\text{Motor Shaft Revolutions 2091:01}}{\text{Driving Shaft Revolutions 2091:02}}$$

0x2092, 0x2892 Enc<n> Feed Constant

Object Code	Record
-------------	--------

Sub	0x00
Name	SubIndex 000
Data type	UNSIGNED8
Access	R/O
Default value	2
PDO mapping	No

Sub	0x01
Name	Feed
Data type	UNSIGNED32
Access	R/W
Default value	0x00000064
PDO mapping	No
Access name	Enc1FeedConstant.Feed

Sub	0x02
Name	Shaft revolutions
Data type	UNSIGNED32
Access	R/W
Default value	0x00000001
PDO mapping	No
Access name	Enc1FeedConstant.ShaftRevolutions

To convert the units:

$$\frac{\text{Feed 2092:01}}{\text{Shaft Revolutions 2092:02}}$$

0x2100, 0x2900 Enc<n> Digital Interface Type

Object Code	Variable
Sub	0x00
Name	Enc1 digital interface type
Data type	UNKNOWN
Access	R/W
Default value	64
PDO mapping	No
Access name	Enc1DigitalInterfaceType

To set up the encoder connected:

64 Encoder (default)

65 SSI

69 Endat

80 EventCounter

0x2101, 0x2901 Enc<n> Digital Interface Control

Object Code	Variable
-------------	----------

Sub	0x00
Name	Enc1 digital interface control
Data type	UNSIGNED16
Access	R/W
Default value	0
PDO mapping	Optional, RPDO only
Access name	Enc1DigitalInterfaceControl

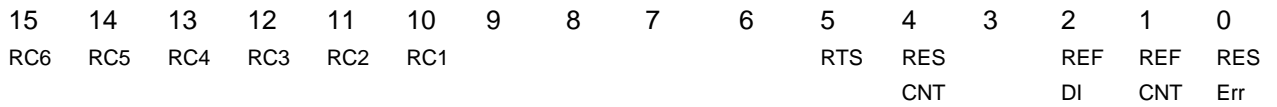

RES Err

- 0 = do nothing
- 1 = reset device

REF CNT

A/B/Ref counter: Rising edge starts referencing the A/B/Ref counter's Ref track

REF DI: (software release 1.10 or higher)

Enables referencing the digital reference input

RES CNT: (software release 1.10 or higher)

A/B/Ref counter: A rising edge resets the current counter reading

RTS: (software release 2.20 or higher)

Reset Timestamp Count: Resets the timestamp counter

RC1...6 (Reset Event Counter 1...6)

A rising edge resets the associated event counter

0x2102, 0x2902 Enc<n> Digital Interface Status

Object Code	Variable
-------------	----------

Sub	0x00
Name	Enc1 digital interface status
Data type	UNSIGNED16
Access	R/O
Default value	
PDO mapping	Optional, TPDO only
Access name	Enc1DigitalInterfaceStatus

15 14 13 12 11 10 9 8 7 6 5 4 3 2 1 0
TTO HOME DIR REF

REF:

0 = A/B/Ref encoder not referenced

1 = A/B/Ref encoder referenced

DIR

0 = clockwise (CW)

1 = counterclockwise (CCW)

HOME

0 = no referencing

1 = home offset value applies, referencing using the digital input was successful

TTO (Timestamp Timeout):

0 = < 6 seconds between two subsequent input signals

1 = new edge not detected within 6 seconds => standstill

0x2103, 0x2903 Enc<n> Digital Interface Config

Object Code	Record
-------------	--------

Sub	0x00
Name	Highest sub-index supported
Data type	UNSIGNED8
Access	R/O
Default value	5
PDO mapping	No

Sub	0x01
Name	Enc1 encoder: level
Data type	UNKNOWN
Access	R/O
Default value	0
PDO mapping	No
Access name	Enc1DigitalInterfaceConfig.Enc1Encoder:Level

Sub	0x02
Name	Enc1 encoder: mode
Data type	UNKNOWN
Access	R/O
Default value	0
PDO mapping	No
Access name	Enc1DigitalInterfaceConfig.Enc1Encoder:Mode

Sub	0x03
Name	Enc1 encoder: index level
Data type	UNKNOWN
Access	R/O
Default value	0
PDO mapping	No
Access name	Enc1DigitalInterfaceConfig.Enc1Encoder:Indexlevel

Sub	0x04
-----	------

Name	Enc1 SSI: use Gray code
Data type	UNKNOWN
Access	R/O
Default value	0
PDO mapping	No
Access name	Enc1DigitalInterfaceConfig.Enc1SSI:Usegreyscale

Sub	0x05
Name	Enc1 event counter: sensitivity
Data type	UNKNOWN
Access	R/O
Default value	0
PDO mapping	No
Access name	Enc1DigitalInterfaceConfig.Enc1EventCounter:Sensitivity

Object for configuring the counter/encoder interface

Subindex 01 (Encoder: Level)

0 HTL (default)

1 TTL

2 RS422

Subindex 02 (Encoder: Mode)

0 multi-turn encoder, no index (default)

1 single-turn encoder

Subindex 03 (Encoder: Index Level)

0 reference on rising edge (default)

1 reference on falling edge

3 reference on both edges

Subindex 04 (SSI: Use Gray Code)

0 straight binary (default)

1 Gray coded binary

Subindex 05 (Event Counter: Sensitivity)

0 count rising edges (default)

1 count falling edges

3 count both edges

0x2110, 0x2910 Enc<n> Digital Interface Bit Size

Object Code	Variable
-------------	----------

Sub	0x00
Name	Enc1 digital interface bit size
Data type	UNSIGNED8
Access	R/O
Default value	
PDO mapping	No
Access name	Enc1DigitalInterfaceBitSize

SSI / ENDAT: Encoder resolution as per the data sheet

0x2111, 0x2911 Enc<n> Digital Interface Baud Rate

Object Code	Variable
-------------	----------

Sub	0x00
Name	Enc1 digital interface baud rate
Data type	UNSIGNED16
Access	R/W
Default value	0x03E8
PDO mapping	No
Access name	Enc1DigitalInterfaceBaudRate

SSI / ENDAT: Clock frequency, in kHz, as per encoder data sheet

0x2120, 0x2920 Enc<n> Index Capture Value

Object Code	Variable
-------------	----------

Sub	0x00
Name	Enc1 index capture value
Data type	UNSIGNED32
Access	R/O
Default value	
PDO mapping	Optional, TPDO only
Access name	Enc1IndexCaptureValue

0x2121, 0x2921 Enc<n> Capture Input Value

Object Code	Variable
-------------	----------

Sub	0x00
Name	Enc1 capture input value
Data type	UNKNOWN
Access	R/O
Default value	
PDO mapping	Optional, TPDO only
Access name	Enc1CaptureInputValue

0x2122, 0x2922 Enc<n> Encoder Track ABRef

Object Code	Variable
-------------	----------

Sub	0x00
Name	Enc1 encoder track ABRef
Data type	UNSIGNED8
Access	R/O
Default value	
PDO mapping	Optional, TPDO only
Access name	Enc1EncoderTrackABRef



Level of encoder track signal

0x2123, 0x2923 Enc<n> Continuous Position Value

Object Code	Variable
-------------	----------

Sub	0x00
Name	Enc1 Continuous position value
Data type	UNKNOWN
Access	R/O
Default value	
PDO mapping	Optional, TPDO only
Access name	Enc1CaptureInputValue

Counter reading without index in single-turn mode

0x213f, 0x293f Enc<n> ErrorCode

Object Code	Variable
-------------	----------

Sub	0x00
Name	Enc1 ErrorCode
Data type	UNSIGNED16
Access	R/O
Default value	
PDO mapping	No
Access name	Enc1ErrorCode

See table for object "0x1003 Pre-defined error field"

0x2408 Event Counter Count

Object Code	Record
-------------	--------

Sub	0x00
Name	Highest sub-index supported
Data type	UNSIGNED8
Access	R/O
Default value	6
PDO mapping	No

Sub	0x01
Name	Event counter channel 1
Data type	UNSIGNED32
Access	R/O
Default value	
PDO mapping	Optional, TPDO only
Access name	EventCounterCount.EventCounterChannel1

Sub	0x02
Name	Event counter channel 2
Data type	UNSIGNED32
Access	R/O
Default value	
PDO mapping	Optional, TPDO only
Access name	EventCounterCount.EventCounterChannel2

Sub	0x03
Name	Event counter channel 3
Data type	UNSIGNED32
Access	R/O
Default value	
PDO mapping	Optional, TPDO only
Access name	EventCounterCount.EventCounterChannel3

Sub	0x04
Name	Event counter channel 4
Data type	UNSIGNED32
Access	R/O
Default value	
PDO mapping	Optional, TPDO only
Access name	EventCounterCount.EventCounterChannel4

Sub	0x05
Name	Event counter channel 5
Data type	UNSIGNED32
Access	R/O
Default value	
PDO mapping	Optional, TPDO only
Access name	EventCounterCount.EventCounterChannel5

Sub	0x06
Name	Event counter channel 6
Data type	UNSIGNED32
Access	R/O
Default value	
PDO mapping	Optional, TPDO only
Access name	EventCounterCount.EventCounterChannel6

0x3000 Digital Input Function Select

Object Code	Record
-------------	--------

Sub	0x00
Name	Highest sub-index supported
Data type	UNSIGNED8
Access	R/O
Default value	4
PDO mapping	No

Sub	0x01
Name	DI01 input function select
Data type	UNKNOWN
Access	R/O
Default value	0
PDO mapping	No
Access name	DigitalInputFunctionSelect.DI01InputFunctionSelect

Sub	0x02
Name	DI02 input function select
Data type	UNKNOWN
Access	R/O
Default value	0
PDO mapping	No
Access name	DigitalInputFunctionSelect.DI02InputFunctionSelect

Sub	0x03
Name	DI03 input function select
Data type	UNKNOWN
Access	R/O
Default value	0
PDO mapping	No
Access name	DigitalInputFunctionSelect.DI03InputFunctionSelect

Sub	0x04
Name	DI04 input function select
Data type	UNKNOWN
Access	R/O
Default value	0
PDO mapping	No
Access name	DigitalInputFunctionSelect.DI04InputFunctionSelect

Object for configuring the input function

0 digital input (default)

1 special function enable

2 timestamp function (subs 0x01 and 0x02)

0x3001 Digital Input Edge Sensitivity Select

Object Code	Record
-------------	--------

Sub	0x00
Name	Highest sub-index supported
Data type	UNSIGNED8
Access	R/O
Default value	4
PDO mapping	No

Sub	0x01
Name	DI01 edge sensitivity select
Data type	UNKNOWN
Access	R/O
Default value	1
PDO mapping	No
Access name	DigitalInputEdgeSensitivitySelect.DI01EdgeSensitivitySelect

Sub	0x02
Name	DI02 edge sensitivity select
Data type	UNKNOWN
Access	R/O
Default value	1
PDO mapping	No
Access name	DigitalInputEdgeSensitivitySelect.DI02EdgeSensitivitySelect

Sub	0x03
Name	DI03 edge sensitivity select
Data type	UNKNOWN
Access	R/O
Default value	1
PDO mapping	No
Access name	DigitalInputEdgeSensitivitySelect.DI03EdgeSensitivitySelect

Sub	0x04
Name	DI04 edge sensitivity select
Data type	UNKNOWN
Access	R/O
Default value	1
PDO mapping	No
Access name	DigitalInputEdgeSensitivitySelect.DI04EdgeSensitivitySelect

Object for configuring the input edges

1 rising edge (default)

2 falling edge

3 both edges

0x3002 Digital Input Filter Select

Object Code	Record
-------------	--------

Sub	0x00
Name	Highest sub-index supported
Data type	UNSIGNED8
Access	R/O
Default value	4
PDO mapping	No

Sub	0x01
Name	DI01 input filter select
Data type	UNKNOWN
Access	R/O
Default value	2
PDO mapping	No
Access name	DigitalInputFilterSelect.DI01InputFilterSelect

Sub	0x02
Name	DI02 input filter select
Data type	UNKNOWN
Access	R/O
Default value	2
PDO mapping	No
Access name	DigitalInputFilterSelect.DI02InputFilterSelect

Sub	0x03
Name	DI03 input filter select
Data type	UNKNOWN
Access	R/O
Default value	2
PDO mapping	No
Access name	DigitalInputFilterSelect.DI03InputFilterSelect

Sub	0x04
Name	DI04 input filter select
Data type	UNKNOWN
Access	R/O
Default value	2
PDO mapping	No
Access name	DigitalInputFilterSelect.DI04InputFilterSelect

Object for selecting the input filter

0 no filter / special function is edge triggered

1 0.3ms filter

2 1.0ms filter (default)

3 3.0ms filter

4 5.0ms filter

5 10ms filter

6 20ms filter

0x3060 DI01 Timestamp Period, 0x0361 DI02 Timestamp Period

Object Code	Variable
-------------	----------

Sub	0x00
Name	DI01 timestamp period, DI02 timestamp period
Data type	UNSIGNED32
Access	R/O
Default value	
PDO mapping	Optional, TPDO only
Access name	DI01TimestampPeriod, DI02TimestampPeriod

Actual time between 2 subsequent input pulses, if the Timestamp input function has been set in 0x3000.

0x3070 DI01 Timestamp Event Count, 0x3071 DI02 Timestamp Event Count

Object Code	Variable
-------------	----------

Sub	0x00
Name	DI01 timestamp event count, DI02 timestamp event count
Data type	UNSIGNED32
Access	R/O
Default value	
PDO mapping	Optional, TPDO only
Access name	DI01TimestampEventCount, DI02TimestampEventCount

Actual counter reading of inputs DI01 and DI02, if the Timestamp input function has been set in 0x3000.

0x3100, 0x3900 Enc<n> DI Capture Value SD

Object Code	Variable
-------------	----------

Sub	0x00
Name	Enc01 DI capture value SD
Data type	INTEGER32
Access	R/O
Default value	
PDO mapping	Optional, TPDO only
Access name	Enc01DICaptureValueSD

0x3101, 0x3901 Enc<n> DI Capture Value HD

Object Code	Variable
-------------	----------

Sub	0x00
Name	Enc01 DI capture value HD
Data type	INTEGER64
Access	R/O
Default value	
PDO mapping	Optional, TPDO only
Access name	Enc01DICaptureValueHD

0x3200, 0x3a00 Enc<n> DI Homeoffset Value SD

Object Code	Variable
-------------	----------

Sub	0x00
Name	Enc01 DI homeoffset value SD
Data type	INTEGER32
Access	R/W
Default value	
PDO mapping	Optional, RPDO only
Access name	Enc01DIHomeoffsetValueSD

0x3201, 0x3a01 Enc<n> DI Homeoffset Value HD

Object Code	Variable
-------------	----------

Sub	0x00
Name	Enc01 DI homeoffset value HD
Data type	INTEGER64
Access	R/W
Default value	
PDO mapping	Optional, RPDO only
Access name	Enc01DIHomeoffsetValueHD

0x6000, 0x6800 Enc<n> Operating Parameters

Object Code	Variable
-------------	----------

Sub	0x00
Name	Enc1 operating parameters
Data type	UNSIGNED16
Access	R/W
Default value	
PDO mapping	No
Access name	Enc1OperatingParameters

15 14 13 12 11 10 9 8 7 6 5 4 3 2 1 0
DIR

Bit 3 DIR

0 = clockwise

1 = counterclockwise

0x6002, 0x6802 Enc<n> Total Measuring Range

Object Code	Variable
-------------	----------

Sub	0x00
Name	Enc1 total measuring range
Data type	UNSIGNED32
Access	R/W
Default value	4000
PDO mapping	No
Access name	Enc1TotalMeasuringRange

Encoder resolution. Relevant for overflow in single-turn mode

0x6003, 0x6803 Enc<n> Preset Value

Object Code	Variable
-------------	----------

Sub	0x00
Name	Enc1 preset value
Data type	UNSIGNED32
Access	R/W
Default value	
PDO mapping	No
Access name	Enc1PresetValue

0x6004, 0x6804 Enc<n> Position Value

Object Code	Variable
-------------	----------

Sub	0x00
Name	Enc1 position value
Data type	UNSIGNED32
Access	R/O
Default value	
PDO mapping	Optional, TPDO only
Access name	Enc1PositionValue

0x6005, 0x6805 Enc<n> Linear Encoder Measuring Step Settings

Object Code	Record
-------------	--------

Sub	0x00
Name	SubIndex 000
Data type	UNSIGNED8
Access	R/O
Default value	1
PDO mapping	No

Sub	0x01
Name	Position step setting
Data type	UNSIGNED32
Access	R/W
Default value	
PDO mapping	No
Access name	Enc1LinearEncoderMeasuringStepSettings.PositionStepSetting

0x6008, 0x6808 Enc<n> High Resolution Position Value

Object Code	Variable
-------------	----------

Sub	0x00
Name	Enc1 high resolution position value
Data type	UNSIGNED64
Access	R/O
Default value	
PDO mapping	Optional, TPDO only
Access name	Enc1HighResolutionPositionValue

0x6009, 0x6809 Enc<n> High Resolution Preset Value

Object Code	Variable
-------------	----------

Sub	0x00
Name	Enc1 high resolution preset value
Data type	UNSIGNED64
Access	R/W
Default value	
PDO mapping	No
Access name	Enc1HighResolutionPresetValue

0x600b, 0x680b Enc<n> High Resolution Raw Value

Object Code	Variable
-------------	----------

Sub	0x00
Name	Enc1 high resolution raw value
Data type	UNSIGNED64
Access	R/O
Default value	
PDO mapping	Optional, TPDO only
Access name	Enc1HighResolutionRawValue

64-bit raw encoder value without any offsets, homing and index

0x600c, 0x680c Enc<n> Position Raw Value

Object Code	Variable
-------------	----------

Sub	0x00
Name	Enc1 position raw value
Data type	UNSIGNED32
Access	R/O
Default value	
PDO mapping	Optional, TPDO only
Access name	Enc1PositionRawValue

32-bit raw encoder value without any offsets, homing and index

0x6030, 0x6830 Enc<n> Speed Value

Object Code	Record
-------------	--------

Sub	0x00
Name	SubIndex 000
Data type	UNSIGNED8
Access	R/O
Default value	1
PDO mapping	No

Sub	0x01
Name	Enc1 speed value channel 1
Data type	INTEGER16
Access	R/O
Default value	
PDO mapping	Optional, TPDO only
Access name	Enc1SpeedValue.Enc1SpeedValueChannel1

0x6031, 0x6831 Enc<n> Speed Parameters

Object Code	Record
-------------	--------

Sub	0x00
Name	SubIndex 000
Data type	UNSIGNED8
Access	R/O
Default value	4
PDO mapping	No

Sub	0x01
Name	Enc1 speed source selector
Data type	UNKNOWN
Access	R/W
Default value	4
PDO mapping	No
Access name	Enc1SpeedParameters.Enc1SpeedSourceSelector

Sub	0x02
Name	Enc1 speed integration time
Data type	UNSIGNED16
Access	R/O
Default value	100
PDO mapping	No
Access name	Enc1SpeedParameters.Enc1SpeedIntegrationTime

Sub	0x03
Name	Enc1 multiplier value
Data type	UNSIGNED16
Access	R/O
Default value	1
Low limit	1
High limit	65535
PDO mapping	No
Access name	Enc1SpeedParameters.Enc1Multiplervalue

Sub	0x04
Name	Enc1 divider value
Data type	UNSIGNED16
Access	R/W
Default value	1
Low limit	1
High limit	65535
PDO mapping	No
Access name	Enc1SpeedParameters.Enc1Dividervalue

Sub 01:

0x04 = use object 0x600B

0xF0 = use object 0x2123

Sub 02:

Integration time in [ms]

Sub 03:

Conversion factor for calculating the speed; result output to 0x6030

Sub 04:

Conversion divider for calculating the speed; result output to 0x6030

0x6500, 0x6d00 Enc<n> Operating Status

Object Code	Variable
-------------	----------

Sub	0x00
Name	Enc1 operating status
Data type	UNSIGNED16
Access	R/O
Default value	
PDO mapping	No
Access name	Enc1OperatingStatus

2.2.9 Technical Data

General

Channels.....	2 (counters/encoders) or 6 (event counters)
EtherCAT Slave Controller	ASIC ET1200
E-bus connector	10-pole system plug in side wall
E-bus load.....	150 mA
I/O / power connection.....	36-pin male
Power supply	24 VDC (-15% ... +20%)
Electrical insulation	500V E-Bus / power supply
Part no.	694.441.51 (CoE)

Counter/encoder

RS422.....	32-bit, 5 MHz
5/24V SE.....	32-bit, 1.6 MHz
Six-step encoder.....	32-bit, 8 kHz
SSI 18-32 bit, 80-1000 Kbit/s	
EnDAT 2.1	100 kHz – 2 MHz
Event counter	2 x HTL/TTL 32-bit, 400 kHz (channels 0, 3) 4 x HTL/TTL 32-bit, 5 kHz (channels 1, 2, 4, 5)

Encoder/counter power supply..... 5 V/150 mA / encoder/counter

Line length

< 30 m, shielded cable

Digital inputs (hardware rev. 2)

Quantity	4
Function	Digital input or Encoder capture / encoder reference or Event counter, 32-bit, 4kHz with timestamp function
Signal level	Off: < 8.0V (EN61131-3 type 3)

3 Appendix

3.1 Order Data

3.1.1 Modules

Kuhnke FIO Counter/Encoder DI (CoE)694.454.53 / 198320

3.1.2 Accessories

Kuhnke FIO Shield Terminal 2x8mm694 412 03 / 196445

Kuhnke FIO Shield Terminal 1x14mm694 412 04 / 196446

Kuhnke FIO Shield Terminal 4x8mm694 412 05 / 196448

Kuhnke FIO Shield Terminal 2x14mm694 412 06 / 197524

Kendrion Kuhnke Automation GmbH
Industrial Control Systems

Lütjenburger Str. 101
D-23714 Malente

Tel.: +49 4523 402 0
Fax: +49 4523 402 201