



CANopen®

EtherCAT®

User Guide

Scout 706, Scout 1006, Scout 1206

Scout 726, Scout 1026, Scout 1226

Panel PLC

E 862 GB

25/01/2022

Table of Contents

1 Preface	5
1.1 Legal Notice.....	5
1.1.1 Version Details	5
1.2 About this Manual	5
1.2.1 Limitation of Liability	5
1.2.2 Terms of Delivery	5
1.2.3 Copyright	6
1.2.4 Software licences	6
1.2.5 Warranty	6
1.3 Reliability, Safety	7
1.3.1 Applicability	7
1.3.2 Target Group of the Instruction Manual	7
1.3.3 Intended Use	7
1.3.4 Reliability	7
1.3.5 Hazard and Other Warnings	8
1.3.6 Other Notices	8
1.3.7 Safety	8
1.3.8 Electromagnetic Compatibility	9
2 System Description.....	12
2.1 Scout Properties	12
2.2 CODESYS V3.....	12
2.2.1 Fieldbus technology	12
2.2.2 CODESYS Control	13
2.2.3 Visualisation	13
2.2.4 Software Releases	13
2.3 Linux Yocto plus RT Patch	14
3 Description of the Apparatus	15
3.1 Application	16
3.1.1 Intended Use	16
3.2 Technical Data.....	17
3.2.1 Scout	17
3.2.2 Scout Quad Core.....	18
3.2.3 Dimensions.....	18
4 Construction and Functionality	19
4.1 Brief Description	19
4.2 General view.....	19
4.3 Labelling and Identification	19
4.3.1 Name Plate.....	19
4.3.2 Serial Number	20
4.3.3 Software Licence Identification	20
4.4 Contents of Package	20
4.5 Transport and Storage.....	21
4.6 Interfaces of Scout 06/26.....	22
4.6.1 Marking on the device	22
4.6.2 Graphics Adapter	23
4.6.3 Ethernet "LAN1" (X2)	23
4.6.4 EtherCAT "LAN2 / ECAT" (X3)	24
4.6.5 "USB" 2.0 host (X4), (X5).....	25

4.6.6	Serial Communication "RS-485 / CAN2" (X7)	26
4.6.7	Serial Communication "RS-232 / CAN1" (X8)	27
4.6.8	Integrated Digital "I/Os" (X10) (Optional)	29
4.6.9	Power Supply "24VDC" (X9)	30
4.6.10	Operative Earth (X11)	30
4.6.11	SD Card (SD)	31
4.7	Indicators and Controls	32
4.7.1	Status LEDs	32
4.7.2	Ethernet "LAN1" (X2), "LAN2" (X3)	32
4.7.3	Stop/Reset Button "S/R"	33
4.8	Accessories and Tools	33
5	Installation and Operation	34
5.1	Mechanical Installation	34
5.1.1	Mounting Position	34
5.1.2	Front Panel Opening	36
5.2	Electrical Installation	37
5.2.1	Operative Earth	37
5.2.2	System Power Supply	37
5.2.3	EtherCAT (X3)	38
5.2.4	CAN / CANopen Station (X7), (X8)	39
5.2.5	Digital Signals and Actuators (X10)	40
5.2.6	Modbus RTU	40
5.2.7	Modbus TCP	40
5.3	Putting into Service	41
5.3.1	General Start-up Information	41
5.3.2	Start-up Prerequisites	41
5.3.3	Turning on the Unit	42
5.3.4	Turning off the Unit	42
5.4	Configuration	43
5.5	Web Interface	43
5.5.1	IP Address	43
5.5.2	Web Interface – Login	44
5.5.3	Web Interface – System	45
5.5.4	Web Interface – Network	46
5.5.5	Web Interface – Downloads	47
5.6	Diagnosis	48
5.6.1	General	48
5.6.2	Indicators	48
5.6.3	Table of Faults	48
5.7	Maintenance / Servicing	49
5.7.1	General	49
5.7.2	Servicing	49
5.7.3	Preventive Maintenance	49
5.8	Durability	51
5.8.1	Repairs / Customer Service	51
5.8.2	Warranty	51
5.8.3	Taking out of Service / Disposal	51
6	Specific Device Functions	52
6.1	System Information	52
6.2	Temperature Sensor	53

6.3	IT Security.....	54
6.4	Splash Screen	54
6.5	Fonts.....	54
6.6	Kernel Update.....	54
6.7	FTP Service.....	55
6.8	System Functions	55
6.8.1	SSH Link	55
6.8.2	Autostart	55
6.8.3	USB update functions	55
7	Operating System.....	56
7.1	Linux	56
8	CODESYS V3 Development Environment.....	57
8.1	Installing CODESYS on the Project Engineering PC	57
8.2	Preparing CODESYS	57
8.2.1	Device Description in CODESYS V3	57
9	Appendix.....	60
9.1	Software Copyrights	60
9.2	Software References	60
9.3	Wiring Example.....	60
9.4	Dimensions	61
9.5	Chemical Resistance	65
9.6	Applicable Standards and Limits	66
9.6.1	Safety Standards and Directives.....	66
9.6.2	EMC Standards	66
9.6.3	Admissible Ambient Conditions.....	66
9.7	Regulations and Declarations.....	67
9.7.1	Mark of Conformity	67
9.8	Approvals.....	67
9.9	Order Specifications	68
9.9.1	Basic Units	68
9.9.2	Order code	69
9.9.3	Accessories	70

1 Preface

1.1 Legal Notice

Contact Details

Kendrion Kuhnke Automation GmbH
Industrial Control Systems
Lütjenburger Straße 101
D-23714 Malente, Germany

Tel. +49 4523 402-0

Fax +49 4523 402-201

Email sales-ics@kendrion.com

E-Mail Support controltechnology-ics@kendrion.com

Web www.kuhnke.kendrion.com

1.1.1 Version Details

Modification History

Date	Comments / Modifications
11.05.2021	Preliminary version
15.06.2021	Original version
25.01.2022	CODESYS Version information

1.2 About this Manual

This technical information is primarily directed to system designers, project engineers and device developers. It does not contain any availability information. We reserve the rights for errors, omissions and modifications. Pictures are similar.

1.2.1 Limitation of Liability

Specifications are for description only and are not to be understood as guaranteed product properties in a legal sense. Exact properties and characteristics shall be agreed in the specific contract. Claims for damages against us - on whatever grounds - are excluded, except in instances of deliberate intent or gross negligence on our part.

1.2.2 Terms of Delivery

The general conditions of sales and service of Kendrion Kuhnke Automation GmbH shall apply.

1.2.3 Copyright

© Kendrion Kuhnke Automation GmbH

This instruction manual is proprietary and protected by copyright.

No part of this document may be reproduced or copied in any way or by any means except expressly permitted in writing by Kendrion Kuhnke Automation GmbH.

Microsoft®, Windows® and the Windows® logo are registered trademarks of Microsoft Corp. in the USA and other countries.

EtherCAT® is a registered trademark and patented technology, licenced by Beckhoff Automation GmbH, Germany.

Further information about the PLCopen organisation is available at www.plcopen.org. CiA® and CANopen® are registered Community trademarks of CAN in Automation e.V.

CODESYS® is a product of CODESYS GmbH.

i.MX6 is a registered trademark of Freescale

ARM ® and Cortex ® are registered trademarks of ARM Limited.

Modbus® is a registered trademark of the Modbus-IDA Organisation.

The companies mentioned herein own the property rights in their company, product and trade names.

1.2.4 Software licences

Firmware

The units' firmware contains open source software. Some of this software is subject to the following and other open source licences:

- GNU General Public License (GPL)
- MIT License
- BSD Zero Clause License
- GNU Lesser General Public License (LGPL)

CODESYS

Like all other CODESYS products, the CODESYS runtime version installed in this system is subject to CODESYS GmbH's end user licence agreement (EULA) as published on the CODESYS website.

1.2.5 Warranty

Warranty is subject to the provisions of the conditions of sale of Kendrion Kuhnke Automation GmbH or any contractual agreements between the parties.

1.3 Reliability, Safety

This chapter just summarises the most important safety instructions and notices, which you will find again in the applicable chapters. Carefully read and respect the safety guidelines as they will provide protection against personal injury and prevent material damage to the units.

1.3.1 Applicability

For reasons of personal safety and to avoid material damages when working with or handling this Kuhnke product, you are advised to take heed of the notes and information contained in this instruction manual.

1.3.2 Target Group of the Instruction Manual

This instruction manual contains all information necessary for the use of the described product (control unit, control terminal, software, etc.) according to instructions. It is written for design, project planning, servicing and commissioning experts. For proper understanding and error-free application of technical descriptions, instructions for use and particularly of notes of danger and warning, extensive knowledge of automation technology is compulsory.

1.3.3 Intended Use

Kendrion's products are designed, developed and manufactured for standard industrial use. They must not be used for any other purposes than the ones specified in the catalogue or the associated technical documentation. Proper and safe operation depends on the products being transported, stored, lined up, mounted, installed, put into service, operated, and serviced correctly. Ambient conditions must be within the admissible limits. Notes and information in the associated documentation apply at all times. For details on how to use this product as intended, refer to chapter Description of the Apparatus, section 3.1 Application, Intended Use.

1.3.4 Reliability

Reliability of products is brought to the highest possible standards by extensive and cost-effective means in their design and manufacture.

These include:

- selecting high-quality components,
- quality agreements with our suppliers,
- actions to avoid static charges when handling MOS circuits,
- worst case planning and design of all circuits,
- visual inspections at various stages of fabrication,
- computer-aided tests of all assemblies and their interaction in the circuit,
- statistical assessment of the quality of fabrication and of all returned goods for the immediate taking of appropriate corrective actions.

1.3.5 Hazard and Other Warnings

Despite the actions described hereunder, the occurrence of faults or errors in electronic control units - even if most highly improbable - must be taken into consideration.





Please pay particular attention to the additional notices which we have marked by symbols throughout this instruction manual. While some of these notices make you aware of possible dangers, others are intended as a means of orientation. They are described further down below in descending order of importance.

Every alert and hazard warning is made up as follows:

Type and source of risk

Potential consequences of non-observance

⇒ Preventive measures

	<p>DANGER</p> <p><i>A DANGER warning makes you aware of an immediately hazardous situation which WILL cause a serious or fatal accident if not observed.</i></p>
	<p>WARNING</p> <p><i>A WARNING makes you aware of a potentially hazardous situation which MAY cause a serious or fatal accident or damage to this or other devices if not observed.</i></p>
	<p>CAUTION</p> <p><i>A CAUTION alert makes you aware of a potentially hazardous situation which MAY cause an accident or damage to this or other devices if not observed.</i></p>
	<p>NOTE</p> <p><i>A NOTE makes you aware of a potentially hazardous situation which MAY cause damage to this or other devices if not observed.</i></p>

1.3.6 Other Notices

	<p>Information</p> <p><i>This symbol draws your attention to additional information concerning the use of the described product. This may include cross references to information found elsewhere (e.g. in other manuals).</i></p>
---	---

1.3.7 Safety

Our products normally become part of larger systems or installations. The information below is intended to help you integrate the product into its environment without dangers to humans or material/equipment.

	<p>DANGER</p> <p>Non-observance of the instruction manual</p> <p><i>Measures for the prevention of dangerous faults or errors may be rendered ineffective or new hazard sources created.</i></p>
---	--

	<ul style="list-style-type: none"> ⇒ <i>Thoroughly read the instruction manual</i> ⇒ <i>Take particular heed of the hazard warnings</i>
--	---

	<p>Information</p> <p><i>To achieve a high degree of conceptual safety in planning and installing an electronic controller, it is essential to exactly follow the instructions given in the manual because wrong handling could lead to rendering measures against dangers ineffective or to creating additional dangers.</i></p>
---	--

Project Planning

- 24 VDC power supply: generate as electrically safely separated low voltage. Suitable devices include split-winding transformers built in compliance with European Standard EN 60742 (corresponds to VDE 0551).
- Power breakdowns or power fades: the program structure is to ensure that a defined state at restart excludes all dangerous states.
- Emergency-off installations must comply with EN 60204/IEC 204 (VDE 0113). They must be operative at any time.
- Safety and precautions regulations for qualified applications have to be complied with.
- Please pay particular attention to the notices of warning which, at relevant places, will make you aware of possible sources of dangerous mistakes or faults.
- Relevant standards and VDE regulations are to be complied with in every case.
- Control elements are to be installed in such a way as to exclude unintended operation.
- Lay control cables such that interference (inductive or capacitive) is excluded if this interference could influence controller operation or its functionality.

Maintenance and Servicing

- Precautions regulation BGV A3 (Elektrische Anlagen und Betriebsmittel) to be observed when measuring or checking a controller after power-up. This applies to section 8 (Admissible deviations when working on parts) in particular.
- Spare parts: Only use parts approved of by Kendrion KUHNIKE. Only genuine Kendrion KUHNIKE modules may be used in modular controllers.
- Modular systems: always plug or unplug modules in a power-down state. You may otherwise damage the modules or (possibly not immediately recognisably!) inhibit their functionality.
- Always dispose of (rechargeable) batteries as hazardous waste.

1.3.8 Electromagnetic Compatibility

Definition

Electromagnetic compatibility is the ability of a device to function satisfactorily in its electromagnetic environment without itself causing any electromagnetic interference that would be intolerable to other devices in this environment.

Of all known phenomena of electromagnetic noise, only a certain range occurs at the location of a given device. It is defined in the relevant product standards.

The design and immunity to interference of programmable logic controllers are internationally governed by standard

IEC 61131-2 which, in Europe, has been the basis for European Standard EN 61131-2.

	Information
	<i>Refer to IEC 61131-4, User's Guideline, for general installation instructions to be complied with to ensure that hardware interface factors and the ensuing noise voltages are limited to tolerable levels.</i>

Interference emission

Interfering emission of electromagnetic fields, HF
compliant to EN 55011, limiting value class A, Group 1

	Information
	<i>If the controller is designed for use in residential areas, high-frequency emissions must comply with limiting value class B as described in EN 55011. Fitting the controller into earthed metal cabinets and installing filters in the supply lines may produce a shielding compliant to the above standard.</i>

General notes on installation

As component parts of machines, facilities and systems, electronic control systems must comply with valid rules and regulations, depending on their field of application.

General requirements concerning the electrical equipment of machines and aiming at the safety of these machines are contained in Part 1 of European Standard EN 60204 (same as VDE 0113).

Electrical immission safeguard

To eliminate electromagnetic interference, connect the control system to the protective earth conductor. Practice best cable routing.

Cable routing and wiring

Keep power circuits separate from control circuits:

- DC voltages 60 V ... 400 V
- AC voltages 25 V ... 400 V

Joint laying of control circuits is allowed for:

- shielded data signals
- shielded analogue signals
- unshielded digital I/O lines
- unshielded DC voltages < 60 V
- unshielded AC voltages < 25 V

Location of installation

Ensure that temperatures, contaminations, impact, vibration or electromagnetic interference are no impediment to the installation.

Temperature

Consider heat sources such as general heating of rooms, sunlight, heat accumulation in assembly rooms or control cabinets.

Contamination

Use suitable casings to avoid possible negative influences due to humidity, corrosive gas, liquid or conducting dust.

Impact and vibration

Consider possible influences caused by motors, compressors, transfer lines, presses, ramming machines and vehicles.

Electromagnetic interference

Consider electromagnetic interference from various local sources: motors, switching devices, switching thyristors, radio-controlled devices, welding equipment, arcing, switched-mode power supplies, converters / inverters.

Particular sources of interference

Inductive actuators

Switching off inductances (such as from relays, contactors, solenoids or switching magnets) produces surge voltages. It is necessary to reduce these extra voltages to a minimum.

Reducing elements may be diodes, Z-diodes, varistors or RC elements. Their rating should conform to the specifications provided by the manufacturer or supplier of the actuators.

2 System Description

2.1 Scout Properties

Its EtherCAT master and two extra CANopen interfaces make Kuhnke Scout, Kendrion's CODESYS control unit, an easy-to-handle touch operating and control panel. CODESYS V3 supports easy programming and efficient engineering. Kuhnke Scout also features 4 optional digital inputs and 4 digital outputs. The fully equipped embedded system is built around a scalable single core or multicore i.MX6 processor complemented by a 7" to 15.6" TFT touch panel display. All its components are very sturdy and available for a long time. Be it a standard or tailored configuration - this "all-in-one" solution will prove to be the better alternative in many units and compact machinery.

- Seamless protection against dust, dirt and spray water (at front)
- Fanless processor technology does not require any maintenance
- Various software packages for variability
- Modbus, EtherCAT® and CAN/CANopen®, OPC UA interfaces for network connectivity

2.2 CODESYS V3

CODESYS is a software platform designed to handle many tasks of industrial automation technology. It is based on the IEC 61131-3 programming system. The tool benefits users with integrated solutions tailored to their practical work and aimed at providing hands-on support with whatever job needs to be done.

CODESYS supports all five languages specified in IEC 61131-3 (International Electrotechnical Commission):

- IL (Instruction List)
- ST (Structured Text), based on PASCAL for structured programming
- LD (Ladder Diagram)
- FBD (Function Block Diagram)
- SFC (Sequential Function Chart)

Apart from the standard IEC languages, CODESYS also supports:

- CFC (Continuous Function Chart) is a FD (function diagram) editor with a fully configurable graphical layout: whereas FD editors are network-based and automatically arrange the function blocks, CFC lets users place the blocks anywhere such that feedback effects can be created without any temporary variables. This feature makes the language the perfect choice for creating an overview of the application.

2.2.1 Fieldbus technology

The CODESYS programming system allows the direct configuration of the EtherCAT, Modbus TCP, CANopen, OPC UA and Modbus TCP/RTU fieldbuses. Protocol stacks can be separately installed as CODESYS libraries for some systems.

2.2.2 CODESYS Control

CODESYS Control is a soft PLC runtime system installed in Scout and adapted to its hardware. It turns Scout into an industrial controller in conformity with IEC 61131-3. This runtime system also features some extra functions that let the controller communicate with other components in its automation environment.

2.2.3 Visualisation

An editor integrated in the CODESYS programming system allows users to create complex visualisation screens and to animate them by means of the application variables. The appropriate visualisation elements are provided by the software. Once created, the screens may help to test an application or to start it up in the programming system's online mode, for example. Running the optional visualisation clients **CODESYS TargetVisu**, **CODESYS HMI** and **CODESYS WebVisu** makes the screens a means of operating the machine or system.

2.2.4 Software Releases

Various software options or combined software options are available for installation in the devices. Please ask product management for the combination that best fits your needs.

Software Options		
Option	Identification	Function
CODESYS TargetVisu	TV	CODESYS control unit extension for outputting visualisation screens to the control unit display. Generates the TargetVisualization immediately in the CODESYS Development System
CODESYS WebVisu	WV	A control unit running CODESYS WebVisu lets you display your own screens created in CODESYS in any web browser environment anywhere in the world.
CODESYS SoftMotion	SM	Use your standard IEC 61131-3 development interface to plan single or multi-axis movements up to and including the plotting of curves - together with the logic application. A Motion Controller running CODESYS SoftMotion provides the PLC programming system with a kit of motion functions. Motion Controllers running CODESYS SoftMotion support many user project planning variants for the given motion tasks by providing PLCopen-certified motion modules, the entire functionality of the IEC 61131-3 programming interface and other tools.
CODESYS SoftMotion CNC+Robotics	CNC	3D-CNC motion control for Motion Controllers with a complete set of 3D-CNC and/or robotics functions including interpolator and kinematic transformations. CODESYS SoftMotion CNC+Robotics provides you with an editor as a convenient way of configuring complex groups of robot axes. Run the editor, choose the appropriate kinematics, set its parameters and link them to the physical robot axes. Standardised function blocks process the robot functions in conformity with PLCopen MotionControl Part 4.

For further information, refer to the product pages of CODESYS GmbH (<https://de.CODESYS.com>).

2.3 Linux Yocto plus RT Patch

Windows Embedded Compact is the new name of Windows CE. It has been developed separately and designed for being tailored to every piece of hardware.

Advantages:

- Real-time capability
- Low memory requirements
- Large selection of drivers
- Multi-core compatibility
- Long-term availability

3 Description of the Apparatus

The panel's powerful processor board with integrated touch screen allows users to run all display and operating functions in a single unit.

It sells with various screen fronts.

Front view of Scout 706/726



Front view of Scout 1006/1026



Front view of Scout 1206/1226



3.1 Application

3.1.1 Intended Use

The panel is designed for on-site use in industrial environments immediately at the machine. It installs in switching cabinets, switching or control panels.

With this range of products, you get a combined control and visualisation or visualisation-only system for a wide range of practical applications, specifically in the fields of mechanical engineering and equipment design:

- all-in-one controller for small machines
- motion controller plus visualisation
- operation and visualisation of automatic equipment
- a single unit for the visualisation and real-time control of general-purpose machine systems

Place of installation

If installed in an enclosed space, the unit's front is protected against dust and water. Ingress protection at the back is IP 20 where it should be protected against humidity and dirt separately.

Waste heat develops in the rear part of the unit. Verify that the place of installation is ventilated properly.

	NOTE
	<p><i>Damage to the unit</i></p> <p><i>Choosing the wrong place of installation may cause damage to the unit.</i></p> <p>⇒ Check section Technical Data for the admissible ambient conditions and the unit's mounting position.</p>

Design constraints for high-risk use cases



It is neither designed nor intended for use in customer systems or together with third-party materials which have been shown to potentially cause fatal or serious personal injury or material or environmental damage if the product fails or produces a fault ("High Risk Use").

High-risk use applications are strictly prohibited.

	DANGER
	<p><i>Danger caused by malfunctions</i></p> <p><i>Fatality, serious personal injury or serious material or environmental damage</i></p> <p>High-risk use applications are strictly prohibited.</p>



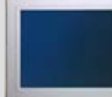

3.2 Technical Data

3.2.1 Scout

General Specifications				
Product name	Scout 706	Scout ET 706	Scout 1006	Scout 1206
Screen size / resolution	7" / 800x480 (WVGA)	7" / 800x480 (WVGA)	10.4" 800x600 (SVGA)	12.1" / 800x600 (SVGA)
				
	220 cd/m ²	220 cd/m ²	350 cd/m ²	400 cd/m ²
Touch screen	4-wire analogue resistive foil touch			
Backlight	White LED, life > 50000h (@ 50% brightness)			
Processor	Freescale i.MX6 Solo, 800 MHz, floating point unit			
Clock	Battery-buffered real-time clock			
Software	Operating system: Linux Yocto plus RT Patch			
RAM / remanent memory	512 MB (DDR3) / 128 kB of remanent data			
Drives	256 MB flash, 1x SD card slot (bootable)			
Networks	1x Ethernet 1 Gbit – RJ45, 1x Ethernet 10/100 Mbit – RJ45			
Ports	1x RS-232, 1x RS-485 (electrically insulated), 2x USB 2.0 host			
Fieldbus interfaces	1x CAN (electrically insulated), Modbus RTU/TCP, EtherCAT® via Ethernet			
2. Graphics adapter	UXGA resolution display port (1600 x 1200), optional DVI adapter			
Integrated I/Os (optional)	4 DI: Delay: 1 ms (interrupt-ready) 4 DO: load: 0.1 A, semiconductor (high side)			
Power supply	24 VDC (+25% /- 20%), (power supply unit rated for control tasks)			
Power consumption				
Service conditions				
Mounting position	Vertical; please contact product management for other mounting positions			
Storage temperature	-25 °C...+70 °C			
Operating temperature	0°C...+50°C, if installed vertically only			
Rel. humidity	Front: 100% / installation space: 5...95% (@ 25° C)			
Front durability	Dilute acids and alkalis, oils and greases, foodstuff, household cleaners → 8.7 Chemical Resistance			
Mechanical properties				
Housing	IP 20, galvanised steel;			
Front panel	IP 65, aluminium front panel, seamless film cover, sealed against dust, dirt and splash water			
Installation	Fitted and screwed into front panel opening			
Weight	850 g	850 g		
Dimensions (WxHxD)	194 x 151 x 56	194 x 192 x 56	280 x 232 x 48	320 x 265 x 49

3.2.2 Scout Quad Core

All units are available with a quad core processor. They differ from the base units above in their processor capacity and memory configuration. Refer to the base units' technical data for all details not listed in this section

General Specifications				
Product name	Scout 726	Scout ET 726	Scout 1026	Scout 1226
Screen size / resolution	7" / 800x480 (WVGA)	7" / 800x480 (WVGA)	10.4" 800x600 (SVGA)	12.1" / 800x600 (SVGA)
				
	220 cd/m ²	220 cd/m ²	350 cd/m ²	400 cd/m ²
Processor	Freescale i.MX6 QuadCore, 800 MHz, floating point unit			
Software	Linux Yocto plus RT Patch			
RAM / remanent memory	1 GB (DDR3) / 128 kB of remanent data			
Drives	256 MB flash, 1x SD card slot (bootable)			
Operating temperature	0°C...+50°C, if installed vertically only			

3.2.3 Dimensions

Refer to section 0 for exact dimensions

4 Construction and Functionality

4.1 Brief Description

The panel's powerful processor board with integrated touch screen allows users to run all display and operating functions in a single unit.

It is designed for on-site use immediately at the machine. Mechanical, system and cabinet engineers benefit from Scout's flexibility when designing powerful applications with a small footprint.

4.2 General view

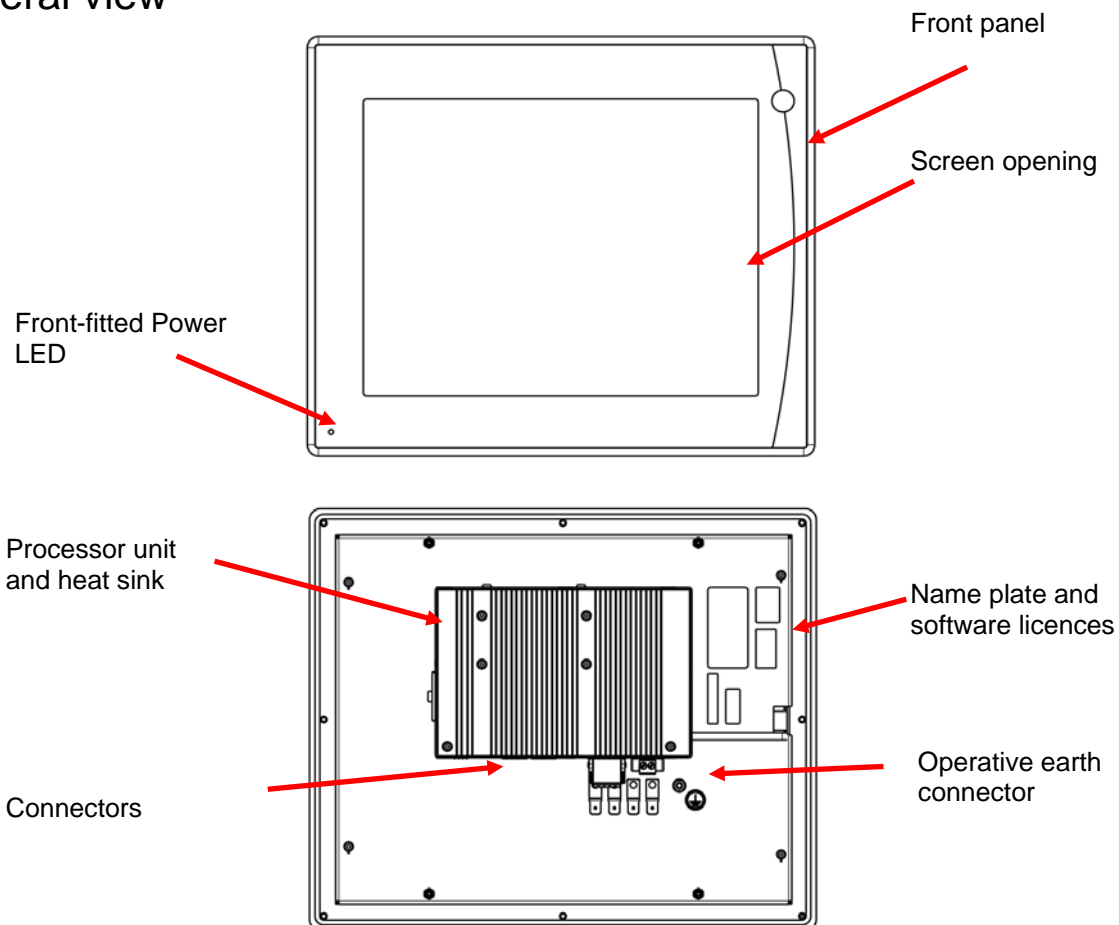

4.3 Labelling and Identification

4.3.1 Name Plate

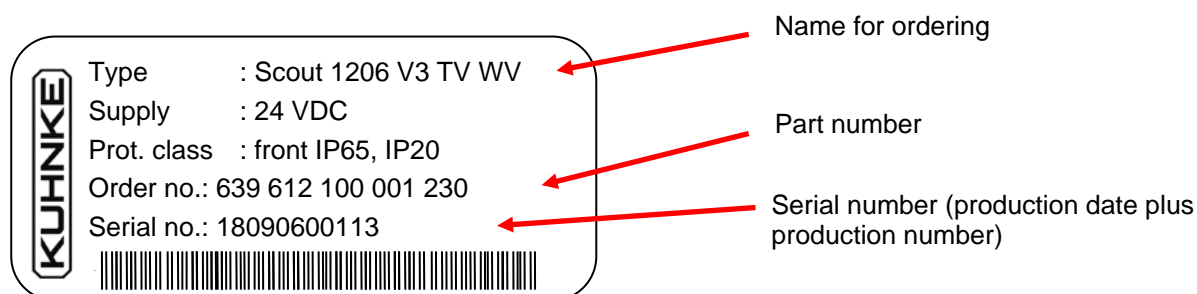

4.3.2 Serial Number

The numerical code incorporates the production date and a serial number. Kendrion Kuhnke can use the numerical code to distinctly identify the model, software and hardware release date. It is a means of traceability.

Make-up of serial number:

YY MM DD NNNNN

Example:

The unit shown above was manufactured on 06th September 2018 and has the serial number 00113.

18 09 06 00113

five-digit number of nth unit built on that day

production date as year month day

4.3.3 Software Licence Identification

Depending on your model variant, different licence labels will be affixed to the back of the device to identify the operating system and the application software.

Version at time of delivery

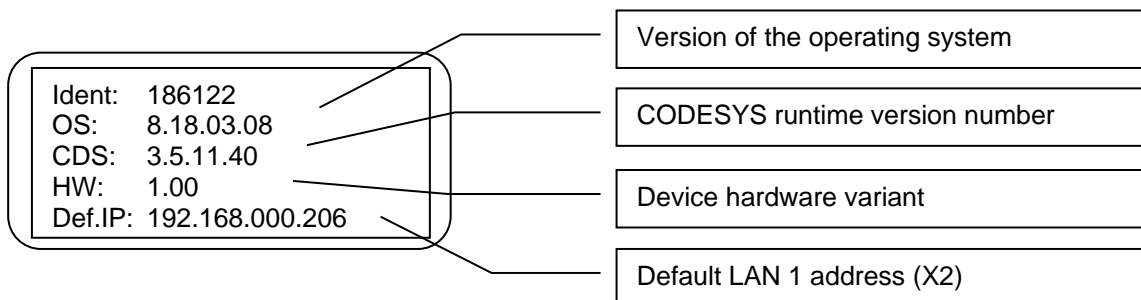

4.4 Contents of Package

The Scout package contains:

Basic unit, supplement, set of connectors, mounting element



4.5 Transport and Storage

Despite the unit's rugged construction, its components inside are still sensitive to impact and vibration. Transport and keep Scout in its original packaging and ensure that the ambient conditions are as specified at all times during transport and storage. Refer to manual section → 8.8.3 Admissible Ambient Conditions for admissible ambient and transport condition details.

The unit contains a permanently installed lithium/metal button cell. None of the package items has to be labelled on any transport route (as of 11/2018).

	NOTE
	<p>Humidity <i>Damage to the unit</i></p> <p>⇒ Verify that no moisture (condensation) is able to collect on the unit when transporting it in cold temperatures or if it is exposed to extremely varying temperatures. Allow the unit to slowly warm up to room temperature before putting it into operation.</p>

4.6 Interfaces of Scout 06/26

All external connectors are located on the back of Scout. All connectors are of the plug-in type.

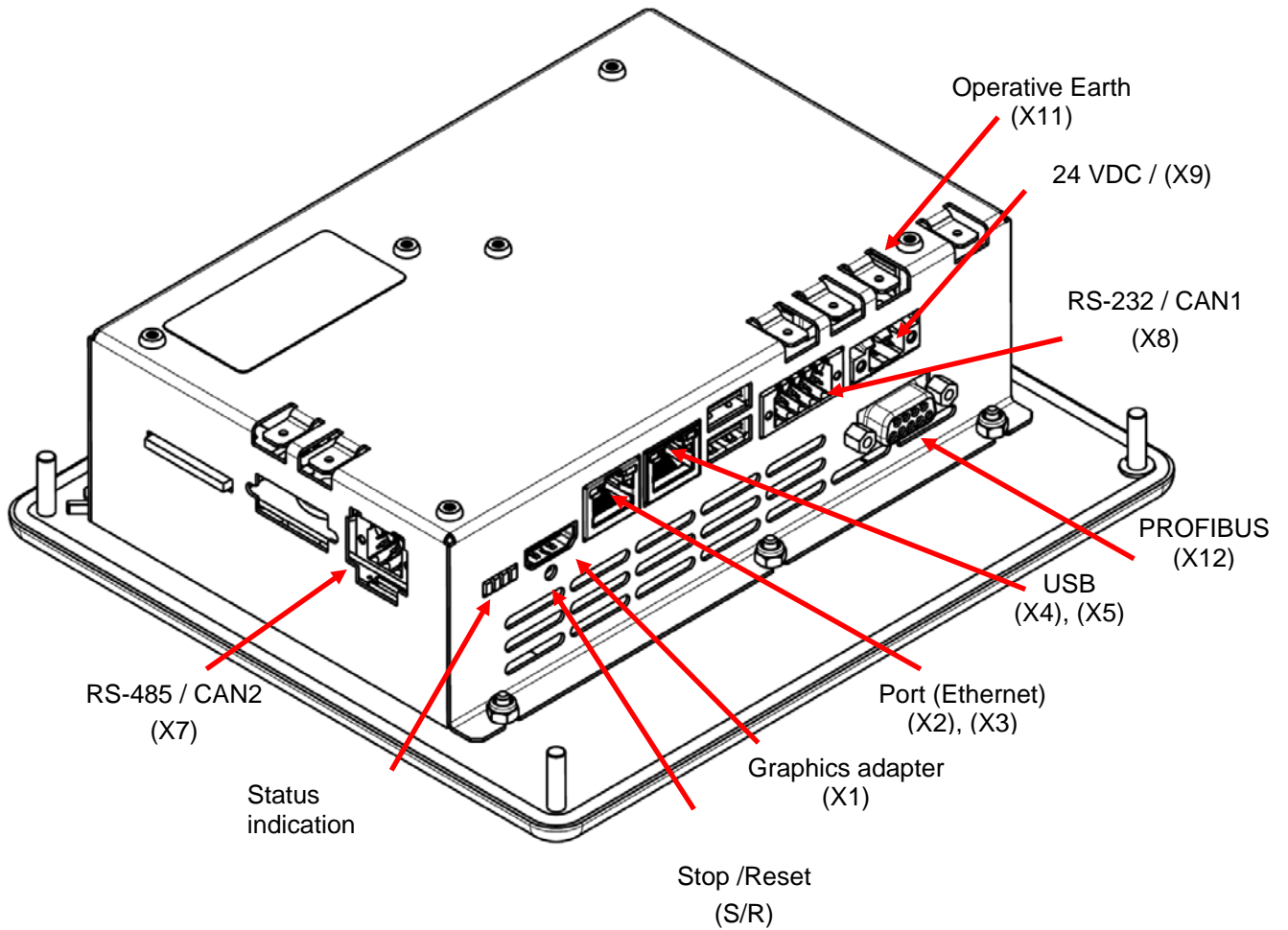

4.6.1 Marking on the device

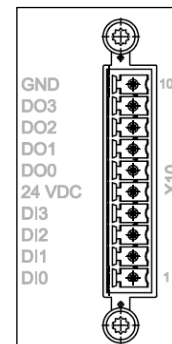
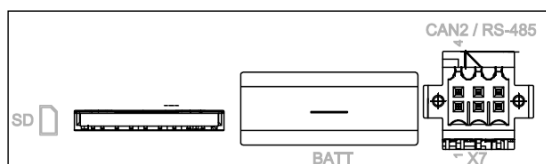
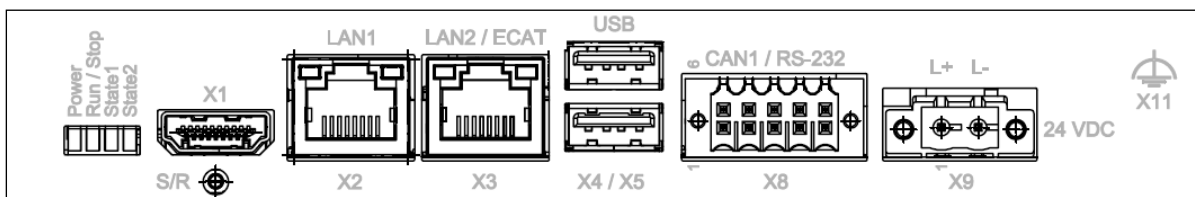

4.6.2 Graphics Adapter

The HDMI graphics adapter is intended for production and is not fit for use in automation environments.

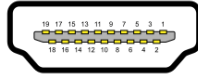

4.6.3 Ethernet "LAN1" (X2)

The on-board 10/100 Mbit base-T Ethernet adapter attaches the unit to a network through its RJ-45 connector. In the runtime system, the LAN1 connection is managed with eth1.

The LEDs labelled "LNK" and "RCV" tell you whether the unit is properly connected to the network.

Pin wiring:

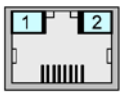

LAN1
X2

X2, X3		LAN1	
Connector	Pin	Function	
 RJ45	1	TX+	
	2	TX-	
	3	RX+	
	4	75 Ohm	
	5	75 Ohm	
	6	RX-	
	7	75 Ohm	
	8	75 Ohm	
LED "LNK"	green / orange	Data link	
LED "RCV"	orange	Activity	

	Information
	Connector (X3) is provided for use as EtherCAT fieldbus interface. The LAN configuration is eth0.

	NOTE
	<p>Unauthorised access to the computer <i>Controller failure and data loss</i></p> <p>⇒ Integration in networks granting public access requires the user to take appropriate measures aimed at preventing unauthorised access.</p>

4.6.4 EtherCAT "LAN2 / ECAT" (X3)

The on-board 10/100/1000 Mbit base-T Ethernet adapter attaches the unit to a network through its RJ-45 connector. In the runtime system, the LAN2 connection is managed with eth0.

Use Ethernet adapter LAN2 / ECAT to link in any other Ethernet-based fieldbus system such as EtherCAT or Profinet. Use your CODESYS project to configure both the interface and the network.

The LEDs labelled "LNK" and "RCV" tell you whether the unit is properly connected to the network.

Pin wiring:

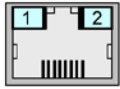

LAN2 / ECAT
X3

X2, X3		LAN1 / LAN2	
Connector	Pin	Function	
 RJ45	1	TX+	
	2	TX-	
	3	RX+	
	4	75 Ohm	
	5	75 Ohm	
	6	RX-	
	7	75 Ohm	
	8	75 Ohm	
LED "LNK"	green / orange	Data link	
LED "RCV"	orange	Activity	



NOTE

Unauthorised access to the computer

Controller failure and data loss

- ⇒ Integration in networks granting public access requires the user to take appropriate measures aimed at preventing unauthorised access.

4.6.5 "USB" 2.0 host (X4), (X5)

The two USB host ports are made for attaching USB peripherals. They provide a max. total current of 0.5 A.

Pin wiring



X4 / X5 USB		
Connector	Pin	Function
USB	B1	VCC
	B2	D-
	B3	D+
	B4	GND



NOTE

USB port overload by excessive power consumption

Machine failure and/or data loss

- ⇒ Only attach USB peripherals whose total power needs do not exceed 0.5 A or supply external power to the USB peripherals by adding an active hub to the line, for example.



NOTE

Electromagnetic interference in industrial environments

Machine failure and/or data loss

- ⇒ Mind that the USB interface is not designed for use in industrial environments but just as a service interface for loading software updates or data up into or down from the control unit.

USB sticks

USB stick users should consider the following points:

- The USB port is mechanically designed to support up to 1,000 plug/unplug operations.
- Pulling off a USB stick during operation is allowed only when no more file operations are being performed. Failure to comply may render the USB stick useless!
If a program still has a file open when the USB stick is pulled, you will find it impossible to close the directory that the file belongs to. In this situation, the system will not respond to any file or directory operation requests because it would be expected to read from a device that is no longer available. Therefore, before pulling off the USB stick, you should always ensure that no program still has an open file loaded from the stick.

4.6.6 Serial Communication "RS-485 / CAN2" (X7)

The **CAN port** complies with standard ISO 11898 and supports baud rates of up to 1 Mbps. The interfaces connecting to X7 are not electrically insulated. Both interfaces are terminated internally. The system uses COM1 for access to the **RS-485** port.

RS 485

CANopen

Connector Wiring:

X7 CAN interface	
Pin	Function
1	RS-485_L
2	RS485_H
3	RS-485_GND
4	CAN_H
5	CAN_L
6	CAN_GND

Connection data



X9 Mating connector (example)	
Type	female PUSH-IN spring connector released by push-buttons
Poles	6, two rows
Order data	e.g. Weidmüller: 2446490000
Wire cross section	min. 0.14 mm ² max. 1.5 mm ² (Core sleeves with collar max. 1 mm ²)
Screw flange	tightening torque 0.25 Nm, screwdriver 0.4 x 2.5

Technical data

RS 485	
Signal	RS 485
Baud rate	max. 115,200 baud, (57.600, 19.200, 9600)
Electrical insulation	no galvanic isolation
Termination	integrated, hard-wired

CAN 2	
Signal	RS 485
Baud rate	max. 1 Mbps, (500, 250, 125 kbps)
Electrical insulation	galvanic isolation
Termination	integrated, hard-wired

4.6.7 Serial Communication "RS-232 / CAN1" (X8)

The system uses COM3 for access to the **RS-232** port. The **RS-232** port is not electrically insulated.

Pin wiring

RS 232

X8 RS 232 interface	
Pin	Function
1	RxD
2	TxD
3	GND
4	Shield
5	Shield

The **CAN port** complies with standard ISO 11898 and supports baud rates of up to 1 Mbps. This port is electrically insulated.

Pin wiring

CANopen

X8 CAN interface	
Pin	Function
6	CAN_H
7	CAN_L
8	CAN_GND
9	CAN_H
10	CAN_L

Technical data

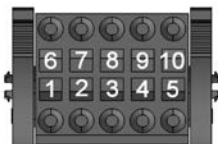

RS 232	
Quantity	1
Signal	RS 232
Baud rate	max. 115,200 baud, (57.600, 19.200, 9600)
Electrical insulation	no galvanic isolation

CAN 1	
Signal	RS 485
Baud rate	max. 1 Mbps, (500, 250, 125 kbps)
Electrical insulation	galvanic isolation
Termination	attached to the connector

Connection data



X8 Mating connector (example)	
Type	female PUSH-IN spring connector released by push-buttons
Poles	10, two rows
Order data	Weidmüller: 2446500000
Wire cross section	min. 0.14 mm ² max. 1.5 mm ² (Core sleeves with collar max. 1 mm ²)
Screw flange	tightening torque 0.25 Nm, screwdriver 0.4 x 2.5



Information

	<p><i>You may connect the CAN termination (wired 120 Ω resistor) directly to the pins.</i></p>
--	--

4.6.8 Integrated Digital "I/Os" (X10) (Optional)

Scout features 4 optional digital inputs and 4 digital outputs which can be used to directly feed signals to or output them from the device. For example, you may directly connect command buttons for operating the device. The outputs may be used for signal lamps.

Pin wiring



X10 I/O connector	
Pin	Function
1	DI0
2	DI1
3	DI2
4	DI3
5	24 VDC (external)
6	DO0
7	DO1
8	DO2
9	DO3
10	0V GND (external)

Technical data

Digital outputs	
Quantity	4
Output current	0.5 A
Load type	resistive, inductive, bulb load
Reverse polarity safeguard	yes
Short-circuit-proof	yes
Electrical insulation	yes
Cable	up to 3 m, please contact the Project Management for longer cable lengths..

24 V sensor power supply	
Quantity	1
Signal	24 VDC
Current rating	100 mA
Functions	short-circuit-proof, reverse current-proof

Digital inputs	
Quantity	4
Signal	24 VDC
Electrical insulation	yes
Input delay	1 ms, interrupt-ready, configured under CODESYS
Signal voltage (0)	DC -3 V ... +5 V
Signal voltage (1)	DC 15 V ... 30 V
Input current	2 mA (typ.)
Electrical insulation	no galvanic isolation
Cable	up to 3 m, please contact the Project Management for longer cable lengths..

Connection data

X9 Mating connector	
Type	male PUSH-IN spring connector released by push-buttons
Poles	10, single row
Order data	Phoenix: 1703955, FMC 1.5/10
Wire cross section	min. 0.2 mm ² max. 1.5 mm ²

4.6.9 Power Supply "24VDC" (X9)

On-board power supply unit (PSU)

Scout features an on-board PSU designed for an input voltage of 24 VDC (+25% / - 20%). The PSU is electrically insulated and protected against reverse polarity.

Both the cord and the power supply unit must have external protection against short circuit and overload triggering at max. 10 A.

Pin wiring



L+ L-

X9 24 VDC power supply	
Pin / symbol	Function
1 / L+	External power supply 24 VDC (18 V ... 32 V)
2 / L-	External power supply, GND

Connection data

X9 Mating connector	
Type	screwed connection with spring bushing
Poles	2, single row
Order data	Phoenix MSTB 2.5/2-G-5.08 Part number: 1777989
Wire cross section	flexible min 0.2 mm ² flexible max. 2.5 mm ²

4.6.10 Operative Earth (X11)

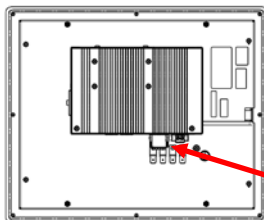

Connect operative earth to the protective earth conductor of the switching cabinet or the system that the PC is installed in. Use the flat plug (6.3 mm x 0.8 mm) or the earth bolt at the back of the unit.

Verify that the cross section is not less than 2.5 mm². Try to keep the lead to the cabinet terminal as short as possible.

**Information**

A low-impedance earth conductor improves the dissipation of interference received via external power supply cables, signal cables or cables of peripheral units.

4.6.11 SD Card (SD)

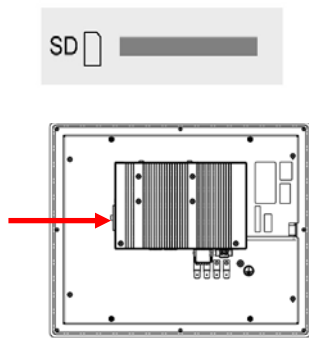

Scout features an SD card slot located on the left side next to the battery compartment. A SD icon marks the slot.

It accepts SD (SD 1.0 or SD 1.1) and SDHC (SD 2) cards at up to 32 Gb capacity run at maximum transfer speed (Class 10).

The file system is FAT32.

Gold-plated contacts ensure that contact resistance is low and that the drive lasts for up to 10,000 plug/unplug action cycles.

The SD card slot has a push-in/push-out plug & eject mechanism. You may have to use a flat object to help you plug in or eject the card.

Industrial vs. commercial products

To operate the unit in industrial environments, you should preferably use industry-grade SD cards instead of commercial ones.

Features of industry-grade SD cards:

- SLC or iMLC memory
- Secure write and clear cycles
- Longer period of availability and early discontinuation announcement

	NOTE
	<p>Soft PLC fails to start <i>Control unit / machine failure</i></p> <p>⇒ To operate the unit in industrial environments, you should preferably use industry-grade SD cards instead of commercial ones. Using other than the above SD cards may jeopardise operational safety.</p>

	NOTE
	<p>Electrostatic discharge (ESD) <i>Inappropriate handling will destroy the memory card</i></p> <p>⇒ SD cards are susceptible to electrostatic discharge (ESD). Please take account of the instructions on how to handle memory cards.</p>

4.7 Indicators and Controls

4.7.1 Status LEDs

The status LEDs indicate the state of the panel PC's modules. RUN / STOP is reserved for indicating the status of the soft PLC, if installed.

Indicators:



LED Description		
Designation	LED	Explanation
Power	off	No 24 VDC power supply
	blue	24 VDC power supplied
Run/Stop	off	
	yellow	Device is booting
	green	PLC status is "run"
	red	PLC status is "stop"
Status1	off	No function
	flashing yellow	No function
Status2	off	No function
	flashing yellow	No function

4.7.2 Ethernet "LAN1" (X2), "LAN2" (X3)

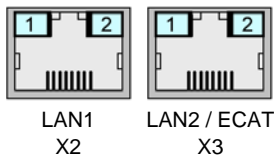

LED Both LAN1 and LAN2		
Designation	LED	Explanation
1	off	10 Mbps
	green	100 Mbps
	orange	1000 Mbps
2	off	
	orange	connected
	flashing orange	activity

4.7.3 Stop/Reset Button "S/R"

The Reset/Stop button is located beneath the status LEDs at the bottom side of the unit.



To avoid it being pushed unintentionally, the Stop/Reset button can be operated using a pointed object (pen, screwdriver) only.

The first push for less than 2 seconds "Stops" the CODESYS PLC program. Run/Stop changes from green to red. Pushing the button again for less than 2 seconds "Starts" the CODESYS PLC program again, Run/Stop changes from red to green ... etc.

Pushing the Stop/Reset button for longer than 3 seconds resets the unit. The Run/Stop LED changes from red to orange. You can now release the Stop/Reset button. The unit will boot.



NOTE

Hardware reset

Data loss

- ⇒ A hardware reset stops the PLC processor. This affects both the PLC program and all the ports. Briefly press the Reset button again to quit this status. This will restart the hardware and re-initialise (default="0") all the variables with the exception of the RETAIN variables.

4.8 Accessories and Tools

Info will be provided later

5 Installation and Operation

	Information
	<p><i>Before installing, servicing or putting Scout into operation, please also read the safety information at the beginning of this document.</i></p>

5.1 Mechanical Installation

Scout is a modern electronic assembly. Handle - specifically mount, operate and service - with care. The unit is operated by means of a touch screen or, more specifically, a resistive touch screen.

Touch screens consist of multiple circuit layers made of different materials. Each of these layers will therefore respond differently to changing climatic or mechanical conditions.

Whereas resistive touch screens are generally very tough, you should still take account of a couple of basic facts when installing them.

Check that the front of the housing is always flat and that the material is not warped, irrespective of which material is used. Do not expose the front panel to any mechanical pressure (bending stress). Non-conformity may cause the touch screen layers to come apart and/or the electrical feed-throughs to be stretched.

Even though this may not lead to a complete touch screen failure, you may still experience an immediate or later loss of touch screen calibration.

In extreme case, the touch sensor may lose its electrical operability.

5.1.1 Mounting Position

The drawings below illustrate the mounting positions specified for Scout. Only install the units as shown or described below. Data sheet information assumes vertical installation in a metal mounting panel such as a cabinet door. Please check the tables below for restrictions regarding other mounting positions.

	CAUTION
	<p><i>Risk of overheating and fire!</i></p> <p><i>Even if operated at admissible ambient temperature, the unit may be destroyed if the way of installation stops the convection cooling from working.</i></p> <p>⇒ Please note the installation instructions and drawings.</p>

Restrictions Regarding other Mounting Positions

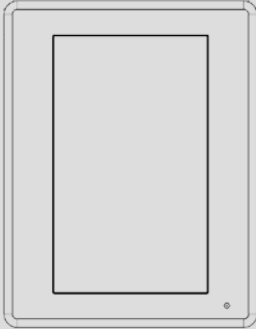
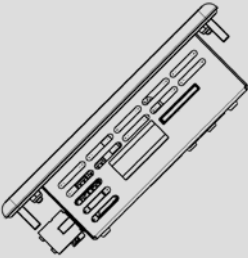
Restrictions regarding other mounting positions		
Mounting position	Restriction	Max. Ambient Temperature
0°		55 °C
90° (upright)		55 °C
- 45°		55 °C

Leave some free space above, beneath, at the sides and back of the unit to allow enough air to circulate. Be sure to leave at least 50 mm of free space on all sides. This specification applies to all variants.

5.1.2 Front Panel Opening

- ⇒ Cut an opening into the control panel area where you wish to install the unit. Refer to the drawing to find the correct dimensions.
- ⇒ Again look at the drawing to know where the holes for the screws should be drilled.
- ⇒ Place the monitor in the opening and alternately screw the nuts from the package onto the screws. To obtain the specified degree of protection and to avoid twisting, the sealing around the monitor should be evenly pressed against the panel all the way around.

	NOTE
	<p><i>Twisting of unit or ingress of moisture</i> <i>Incipient or complete touch screen damage or leakiness</i></p> <ul style="list-style-type: none"> ⇒ Verify that the material around the installation opening is hard enough to ensure that the panel PC is mounted correctly at all times. In order to achieve the specified ingress protection, the material must not warp under the load of the mounting bolts or operation.

	Information
	<p><i>Check the package for the nuts, washers and tooth lock washers needed to mount the unit.</i></p>

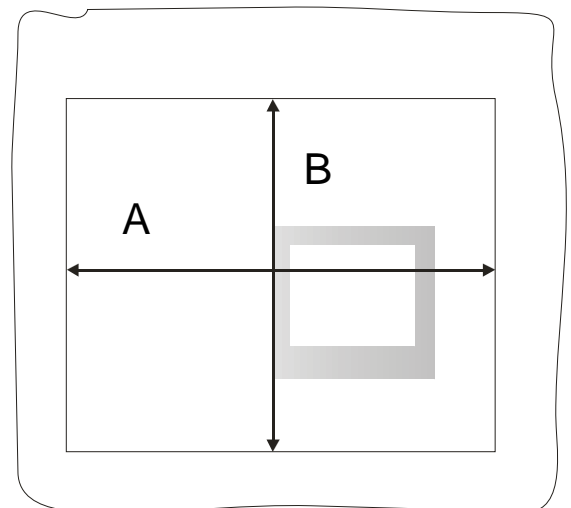

Front panel opening

Model	Width A	Height B
Scout ET 706*/ET 726	184* mm	172* mm
Vico / Scout 706/726	190 mm	118 mm
Vico / Scout 1006/1026	250 mm	202 mm
Vico / Scout 1206/1226	296 mm	240 mm

* Please note the drawing

5.2 Electrical Installation

The connectors are located on the back of Scout or as described in section → 4.6 Interfaces of Scout 06.

Proceed in the order below to wire up the unit:

- ⇒ turn off the unit,
- ⇒ unplug the unit from the mains/power supply,
- ⇒ attach all cables to the unit and any peripherals,
- ⇒ check that all cables are firmly attached at both (female and male) ends,
- ⇒ reconnect all units with the mains/power supply.

5.2.1 Operative Earth

Operative earth is not a safeguard but a means of improving the immunity to noise. It is solely intended to dissipate noise current but not to protect persons from contact.

It connects either to one of the 6.3 mm x 0.8 mm blade connectors or an earth bolt at the back of the unit.

Take heed of the following points to ensure that noise currents are safely dissipated:

- Try to keep a very short distance between the unit and the central earth bonding point on the control cabinet.
- Check that the cable/earth conductor diameter is 2.5 mm² or greater.

Take heed of the specified conductor shielding; check that all data link cables attached to the unit have shielded wires and attach to the unit's earthing terminals.

	Information
	<i>Earth wires should be short and have a large surface (copper mesh). Refer to http://de.wikipedia.org/wiki/ground_(electronics) or a similar source for further details.</i>

5.2.2 System Power Supply

Terminals L+ and L- of connector X9 are used to supply power to Scout. The wires should have a cross section of 0.75 mm² to 2.5 mm² and a connector sleeve. Attach the connector sleeves to the wires, then insert the wires in the terminal chamber and tighten the screw terminals using a suitable screwdriver.

Check the pin wiring specified for the unit's power supply connector when wiring up the unit.

	CAUTION
	<i>Damage to the unit due to supplying excessive or the wrong power</i> <i>Wrong voltage or wrong polarity of the connectors may destroy the unit.</i>
	⇒ Please refer to the pin wiring shown on the unit → 4.6.8 Power Supply "24VDC" (X9)

Power supply fusing

The cord must have external protection against short circuit and overload triggering at max. 10 A, min. 60 V.

Power supply wiring example

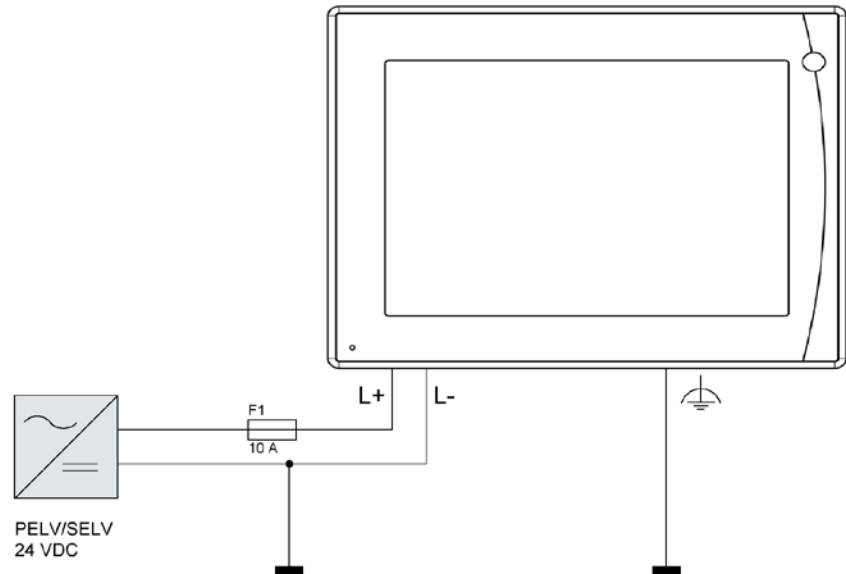

5.2.3 EtherCAT (X3)

EtherCAT is an industry-grade real-time Ethernet fit for use for both hard and soft real-time requirements of automation technology. Please take heed of the notices below to ensure safe operation of your EtherCAT fieldbus system.

- To connect your EtherCAT devices, only use category 5 (CAT5) Ethernet cables pursuant to EN 50173 or ISO/IEC 11801.
- Owing to the automatic cable detection feature (auto crossing) you can interconnect EtherCAT devices by both symmetrical (1:1) and crossover cables.
- Up to 100 metres length of cable are allowed between any two EtherCAT devices.

**Information**

Torsional and permanent tensile stress near the Ethernet cable connector strain the plug connections. An Ethernet connector with too much play and insufficient guidance in its socket will provoke tipping in the plug connections which often causes contact and, thus, fieldbus interruptions.

Vibration tests show that the robustness of a connection increases with the depth of plugging the connector into the socket. Mechanical requirements of vibration and impact resistance are commonly known to be stricter in industrial environments than in IT environments.

Depending on the manufacturer and system, the plugging depths of commercially available connectors vary from about 8 mm to almost 12 mm and are rated at about 9 mm for standard connectors. According to manufacturer specifications, connectors designed for industrial environments have a plugging depth of up to 11.8 mm.

5.2.4 CAN / CANopen Station (X7), (X8)

CAN is a 2-wire bus that all stations are connected to in parallel. To avoid voltage reflection, verify that the bus is terminated by a 120 ohm (or 121 ohm) termination resistor at either end. You will need these resistors even if cables are very short.

Connector CAN1 (X8) has double CAN terminals. If your unit is a bus end point, you may connect a termination to one of them. The easiest way to do so is to directly attach a wired 120 Ω resistor to the plug contacts. If your unit is located somewhere along the bus, the spare contacts are used to attach the next station.

The CAN2 (X7) interface is not electrically insulated. In this case, the next station or the termination must therefore connect to some other point.

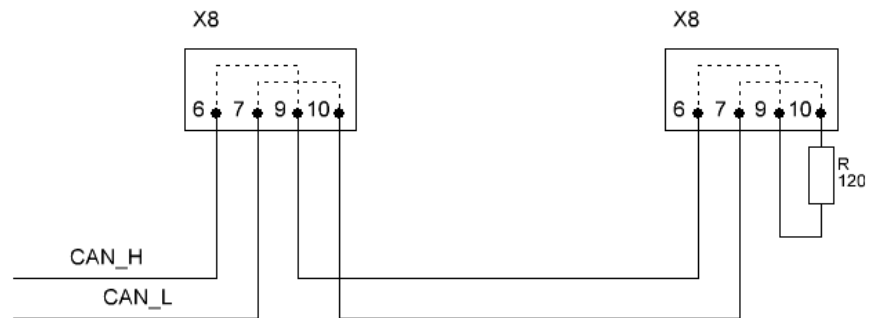

Length of CAN bus

The maximum length of a CAN bus is limited by the signal transit time. Mind to adapt the baud rate to the actual line length.

Length of CAN bus	
Length	Max. Baud Rate
< 20 m*	1 Mbps
< 100 m	500 kbps
< 250 m	250 kbps
< 500 m	125 kbps
< 1000 m	50 kbps

5.2.5 Digital Signals and Actuators (X10)

Connector X10 allows you to output 4 control signals to signal transmitters or actuators such as relays or other electrical loads. Its switching voltage is rated at 24 VDC. Since pin 1 of connector X10 carries the earth potential, signal lamps can be actuated directly at the terminal. Every output can carry up to 0.5 A.

Connector X10 houses the control unit's digital inputs. The control unit can supply power to the sensors / switches (X10, pin 6). The power supply to switch contacts and sensors is short-circuit-proof and protected against polarity reversal. The power supply can carry up to max. 100 mA.

Sensor and actuator connection example:

Application example:

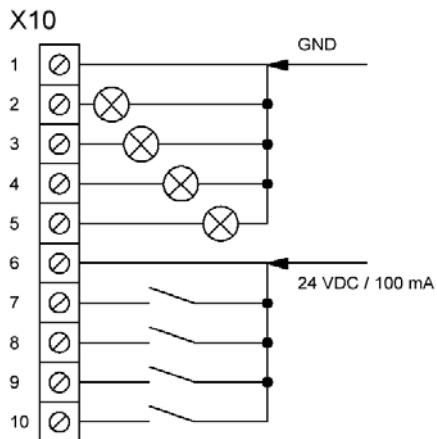

5.2.6 Modbus RTU

The Modbus protocol transfers via the RS-485 interface (X7). The RS-485 interface is a 2-wire bus that all stations are connected to in parallel. To avoid voltage reflection, verify that the bus is terminated by a 120 ohm (or 121 ohm) termination resistor at either end. You will need these resistors even if cables are very short.

5.2.7 Modbus TCP

Ethernet-TCP/IP networks use the "Transport Control Protocol" (TCP) to transfer the Modbus TCP application protocol for Modbus. The target device can use interfaces LAN 1 or LAN 2 for protocol implementation. It is then selected in the master configuration of the CODESYS Development System.

5.3 Putting into Service

5.3.1 General Start-up Information

	CAUTION
	<p>Risk of burns</p> <p><i>The surface of the device may become very hot. Unprotected contact causes a risk of burning yourself.</i></p> <p>⇒ Avoid direct contact with the unit in operation. Put on suitable safety gloves before touching the unit.</p>

Have the following tools at hand for starting the unit for the first time:

- USB keyboard
- USB mouse

Touch screen operation

Control objects on the touch screen are operated by applying a slight but noticeable pressure on them with your finger or the touch stylus.

	NOTE
	<p>Damage to the touch screen by pointed or sharp objects</p> <p>Destruction of front</p> <p><i>Do not use pointed or sharp objects to operate the touch screen.</i></p> <p>⇒ Avoid sudden or impact-like touch screen contact by hard objects. This may significantly reduce touch screen life or provoke its complete failure. Touch the screen of Touch with your finger or the stylus only.</p>

	Information
	<p><i>Always touch a single on-screen control object at a time. You may otherwise start unintended actions.</i></p>

5.3.2 Start-up Prerequisites

- Functional earth is connected.
- All cables are attached properly.
- Power is supplied to the unit.

5.3.3 Turning on the Unit

Connect the unit to the power supply.

The user interface of the operating system displays after the boot-up routine. Remember that the display resolution is set in the Image. In case a soft PLC is installed, it starts automatically and displays its status on the welcome screen.

5.3.4 Turning off the Unit

You may directly unplug the unit from the power supply. Remanent data will be save automatically.

5.4 Configuration

A web interface is used to configure Scout 06-series units → 5.5

5.5 Web Interface

5.5.1 IP Address

Scout 06 units are set to a permanent IP address and subnet mask in the factory.

IP address LAN 1 (X2): 192.168.0.216

Subnet mask: 255.255.255.0

To connect to the unit for the first time, mind that your PC's IP address must be in the same range as that of the unit.

This may involve changing your PC's IP address.



NOTE

Duplicate IP addresses

Assigning the same IP address to two different devices may cause serious network problems.

- ⇒ Check your network for duplicate IP addresses.
- ⇒ To put the unit into operation, we recommend using a direct network connection between the unit and your programming PC and assign set IP addresses to both. You may have to use a cross-over network cable.

5.5.2 Web Interface – Login

First of all, run a browser application on your PC to launch the web interface of Scout/Econo 06-series units. Internet Explorer, Chrome and Firefox are the current choice of browsers.

Type the following IP address into your browser's address bar:

LAN 1 connection (X2)

http://192.168.0.216

The following web site displays:

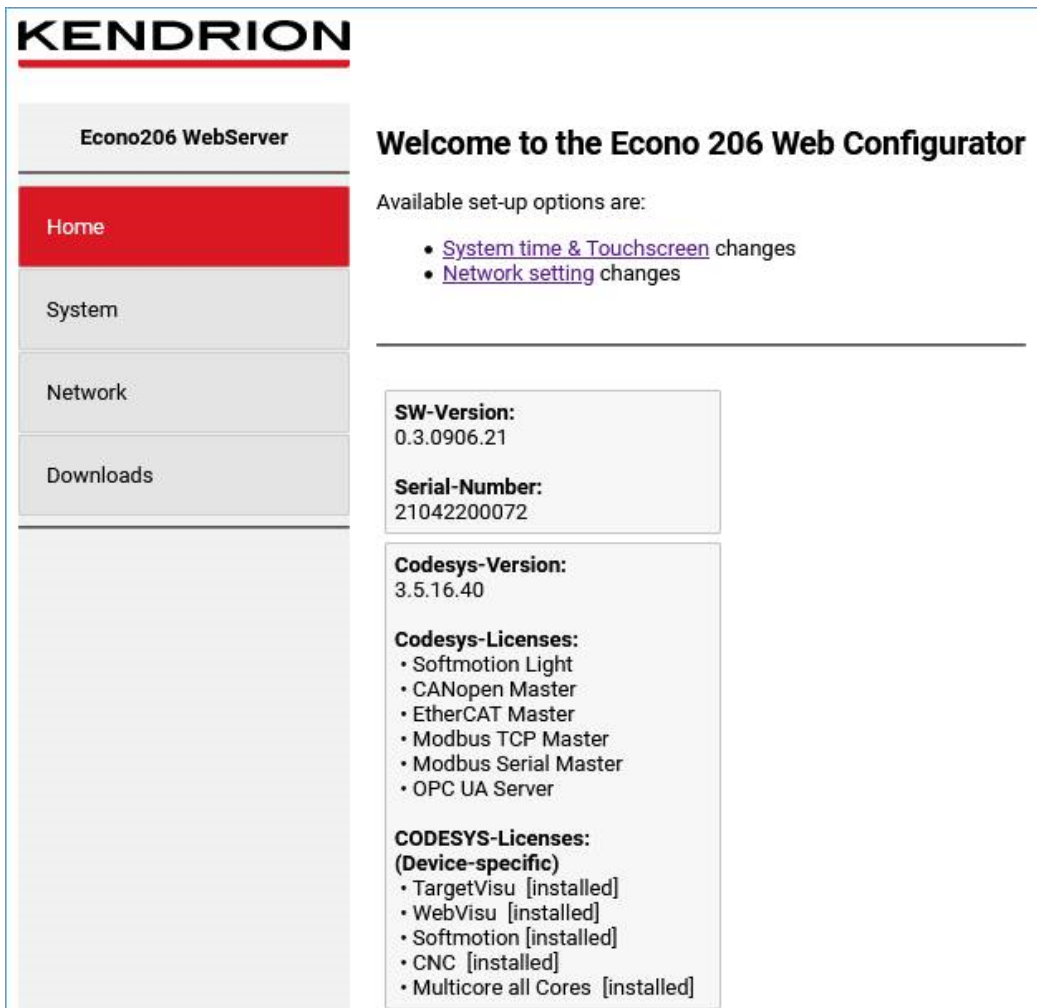

KENDRION

Econo206 WebServer

Welcome to the Econo 206 Web Configurator

Available set-up options are:

- [System time & Touchscreen](#) changes
- [Network setting](#) changes

SW-Version:
0.3.0906.21

Serial-Number:
21042200072

Codesys-Version:
3.5.16.40

Codesys-Licenses:

- Softmotion Light
- CANopen Master
- EtherCAT Master
- Modbus TCP Master
- Modbus Serial Master
- OPC UA Server

CODESYS-Licenses:
(Device-specific)

- TargetVisu [installed]
- WebVisu [installed]
- Softmotion [installed]
- CNC [installed]
- Multicore all Cores [installed]

*The actual web interface view depends on the options available to you

Information

- Version of the software installed
- Serial number of the device
- CODESYS runtime version
- Default interfaces and fieldbuses supported
- Optional licences for interface and fieldbus support

5.5.3 Web Interface – System

KENDRION

The screenshot displays the 'System' configuration page of the Kendrion web interface. On the left is a navigation menu with 'System' highlighted in red. The main content area is divided into four sections:

- System Time:** Features a 'Timezone Settings' dropdown menu set to '(UTC) Coordinated Universal Time'. Below it are 'Date/Time Local' (21.06.2021 15:12:48) and 'Date/Time Econo206' (07.06.2021 07:56:50) fields, with an 'Edit' checkbox. A large 'Adopt local Date/Time' button is at the bottom.
- Touchscreen Calibration:** Includes a warning that calibration stops Codesys Control and requires a restart, followed by a 'Touchscreen Calibration' button.
- Display brightness:** Shows a control with '+' and '-' buttons and a central display of '65%'.
- Temperature:** Displays 'SoC's internal temperature' and a large box showing 'Temperature: 38°C'.

Settings:

- Date and time
- Start Touch Calibration
- Display brightness
- Temperature of processor core

Your settings will be saved when quitting the page

5.5.4 Web Interface – Network

KENDRION

Web configuration	eth0 (IPv4 link down)	eth1
Home	DHCP <input type="checkbox"/> IP Address 192 . 169 . 0 . 216 Subnet Mask 255 . 255 . 255 . 0 Default Gateway 192 . 169 . 0 . 1 MAC Address: 00 : 05 : 51 : 07 : 55 : 83 <input type="button" value="Change Settings"/>	DHCP <input type="checkbox"/> IP Address 192 . 168 . 0 . 216 Subnet Mask 255 . 255 . 255 . 0 Default Gateway 192 . 168 . 0 . 1 MAC Address: CA : B4 : DD : 4D : DD : 4E <input type="button" value="Change Settings"/>
System		
Network		
Downloads		

*The actual web interface view depends on the options available to you

Settings

- LAN1 & LAN2 network configuration

5.5.5 Web Interface – Downloads

KENDRION

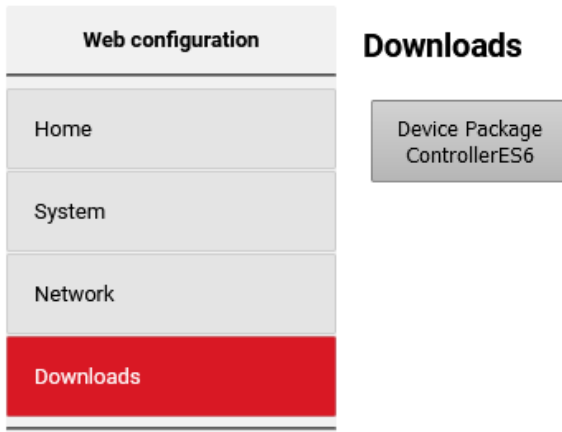

*The actual web interface view depends on the options available to you

Settings

- Download of Device Package ControllerES6
 - CODESYS Device Description ControllerES6
 - Device Description ControllerES6IO
 - Device Description KICS_ModbusComPort
 - System Library ControllerES6

5.6 Diagnosis

5.6.1 General

	Information
	<i>Under extreme ambient conditions such as high humidity and temperature, the touch screen surface may sometimes develop some undulation. This is a purely optical effect and no functional constraint.</i>

5.6.2 Indicators

	Information
	<i>Refer to sections 4.7.1 Status LEDs and 4.7.2 Ethernet "LAN1" (X2), "LAN2" (X3) to find details of the unit's indicators.</i>

5.6.3 Table of Faults

Table of Faults		
Description	Possible Cause	Recommended Action
Date and time are not stored permanently	The battery buffering the real-time clock is low.	Replace battery → Replacing the battery
Second monitor stays blank	The screen resolution is detected and the PC set to it automatically. You may see a blank screen if a display fails to transmit a (recognisable) identification.	Replace the monitor or the DisplayPort adapter

5.7 Maintenance / Servicing

5.7.1 General

Only qualified persons are allowed to work on Scout.

	CAUTION
	<p><i>Wrong or excessive supply voltage</i> <i>Electric shock hazard</i></p> <p>⇒ Do not plug, mount, unplug or touch the connectors during operation! You may otherwise provoke destruction or malfunction. Turn off all power sources before working on the unit. This also applies to any peripherals connected such as encoders, programming devices with external power source, etc.</p>

5.7.2 Servicing

Scout requires neither servicing for the specified service life nor any action if it is kept and operated at the admissible ambient conditions specified in section Technical Data.

5.7.3 Preventive Maintenance

Cleaning the front panel

To prevent other persons from unintentionally operating the system, be sure to turn off Scout before you clean the front panel.

	CAUTION
	<p><i>Unintentional start of functions</i> <i>Movements of machine parts</i></p> <p>⇒ In order to avoid unintentionally starting a function by touching the screen or pressing controls when cleaning the unit, verify that the unit is properly turned off.</p>

Use a damp cloth to clean the unit. To moisten the cloth, only use water with washing liquid, screen cleaner or alcohol (ethanol) in it. Do not spray the cleaning agent straight on the unit but always on the cloth first. Do not use aggressive solvents, chemicals, scouring agents, compressed air or steam jets.

To avoid damaging the front panel by cleaning, please take heed of the following:

- Do not use pressure washers or steam jet ejectors.
- Do not use corrosive cleaning agents, diluted acids, scouring cleaners or hard objects for cleaning.
- Do not put too much pressure on the front when cleaning it.

Prevent inadmissible contamination while operating and storing the unit.

	Information
	<i>For chemical resistance information, please read ch. → Chemical Resistance.</i>

Replacing the battery

Under the plastic cover of the unit, there is a 3 V lithium battery for buffering the power supply to the real-time clock. The battery lasts for about 4 to 6 years. To ensure uninterrupted operation, we recommend replacing the battery after not later than 3 years.

To retain the date and time settings, you should replace the battery while the unit is running. Please use the pull strip to remove the old battery and remember to put the strip back in for ease of later replacement.

Replace the lithium battery (type CR2032) with a battery of the same type.

Procedure

Remove the black plastic cover from the battery compartment and carefully pull at the pull strip to remove the battery.

Insert the new battery and pull strip. Check the type and polarity of the battery.

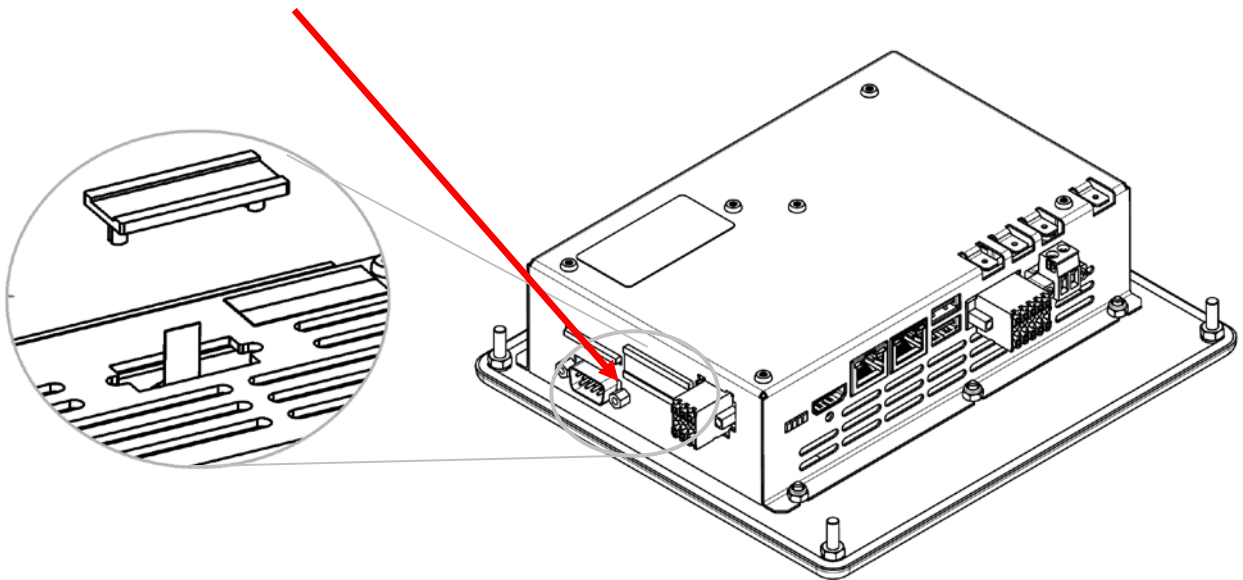

Information

Date and time settings cannot be saved if the battery is discharged.



Information

Do not throw the old lithium battery into the domestic waste.

Dispose of the battery compliant to local regulations concerning the disposal of hazardous waste (e.g. by taking it to the special collecting points).

5.8 Durability

5.8.1 Repairs / Customer Service

	Information
<i>Only the manufacturer or customer service providers authorised by the manufacturer are allowed to do repairs and perform corrective maintenance.</i>	

5.8.2 Warranty

The statutory period and conditions of warranty apply. Warranty expires if unauthorised attempts are made to repair the unit / product or any other intervention is performed.

5.8.3 Taking out of Service / Disposal

Disposal requires Scout to be disassembled and entirely taken apart. All metal components can be given to metal recycling.

Electronic scrap

Sort and dispose of electronic components by type. For details on proper disposal please check your national laws and regulations making sure that your method of disposal complies with them.

Treat the packaging as recyclable paper and cardboard.

6 Specific Device Functions

6.1 System Information

CODESYS library "kics_sysinfo" contains the hardware-specific device information. Run the Library Manager to add the library to your project.

The Library Manager hosts short a documentation of every available function blocks and functions. Please contact Kendrion Kuhnke's Product Management if you need further information.

6.2 Temperature Sensor

Run the web interface to take a reading of the temperature sensor in the CPU. The reading allows you to judge the capacity load usage of the unit and the ventilation. The table below relates the CPU temperature to the ambient temperature at about 80% CPU load.

The CPU's rated maximum working temperature is 105 °C.

CPU working temperature after thermal compensation		
Conditions	Ambient temperature	CPU temp.
Power supplied: 28.8V 80% CPU load	20 °C	62 °C
	30 °C	72 °C
	40 °C	82 °C
	50 °C	92 °C

The graph below illustrates how the CPU life depends on the CPU temperature. To prevent the CPU from wearing down prematurely, try not to exceed max. 100 °C under continuous duty. Ensure sufficient ventilation when the unit is operating.

In extended commercial mode, both Scout and Vico run at 792 MHz (green borderline).

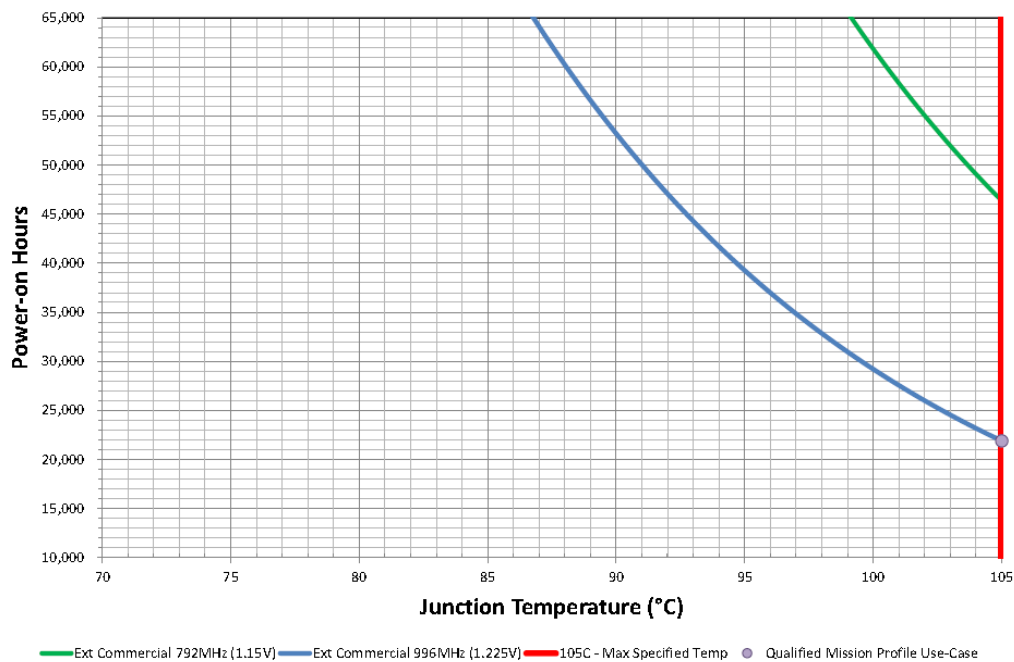

Temperature monitoring

Use the following hands-on limits should your project require that the unit's temperature be monitored:

- Alert at CPU temperature ≥ 95 °C for longer than 10 minutes (machine keeps running).
- Alert at CPU temperature ≥ 99 °C for longer than 15 minutes (machine stops).
- Alert at CPU temperature ≥ 102 °C for longer than 15 seconds (machine stops).
- Alert at CPU temperature ≥ 104 °C for longer than 1 second (machine stops).

6.3 IT Security

Automation devices contain functional units that should be protected. These include the conventional control and regulation functions and algorithms but also the facility users' production and other data. Since there is no automation solution without faults, some potential weak points and causes of risks remain.

Whereas the main threat is from LAN networks, attackers may also use local interfaces.

Consider the following routes of attack:

- Interfaces (USB, LAN, WLAN, Bluetooth,.....)
- Services, drivers, protocols (RPC, HTTP(S),.....)
- Authentication, encoding (compulsory registration, encrypted password)
- Physical access (closed rooms, cabinets)
- Third-party systems or personnel

Take every effort to avoid exposing the PLC and controller networks to open networks or the Internet. Safeguarding should include extra data link layers such as remote access via VPN as well as sophisticated firewalls. As a basic rule, you should disable or restrict the access to all interfaces you do not need. Segmentation (e.g. by a router with a firewall) may be another effective means of protection.

	NOTE
	<p><i>Unauthorised access to the computer</i> <i>Controller failure and data loss</i></p> <p>⇒ Integration in networks granting public access requires the user to take appropriate measures aimed at preventing unauthorised access.</p>

6.4 Splash Screen

You may display a picture while the unit is booting. Factory defaults are set to showing a Kendrion tile. Run the update tool to change the picture, as appropriate. Please contact our product management.

6.5 Fonts

The following fonts are installed in the factory:

LiberationSans-Italic.ttf
 LiberationMono-Regular.ttf
 LiberationSans-Bold.ttf
 LiberationMono-BoldItalic.ttf
 LiberationSans-Regular.ttf
 LiberationSerif-Bold.ttf
 LiberationMono-Italic.ttf
 LiberationSerif-Italic.ttf
 LiberationSans-BoldItalic.ttf
 LiberationSerif-BoldItalic.ttf
 LiberationSerif-Regular.ttf
 LiberationMono-Bold.ttf

Please contact Kendrion Kuhnke's product management to add other/your own fonts to the ones installed.

6.6 Kernel Update

The kernel updates from a USB stick. A status LED tells you how the update process is progressing. Please contact our product management for details of how to update the kernel and what it entails.

6.7 FTP Service

A vsftpd server is installed in the unit.

The vsftpd server supports the File Transfer Protocol. Its acronymic name dissolves into Very Secure File Transfer Protocol Daemon.

It takes a single configuration file (/etc/vsftpd.conf) to set up vsftpd. It is initially set to supporting anonymous FTP only.

6.8 System Functions

6.8.1 SSH Link

SSH is a network protocol, which lets you establish a safe and encrypted network connection to the unit.

To do so under Windows, you will need an SSH client such as Putty.

You will need the following details to log in using SSH:

Server address:	192.168.0.216
User name:	root
Password:	root
Port	22 (Default)

6.8.2 Autostart

Run background application "systemd" to configure any other applications you may wish to run on Scout. It takes some experience to actually configure this feature. Our product management is there to help you.

6.8.3 USB update functions

You can use the USB update functions to load customized system configurations, play the CODESYS boot application on the device or perform a complete system update. A template for the system configuration and for loading a CODESYS boot application can be found on the Internet in our product finder.

7 Operating System

7.1 Linux

Linux Yocto plus RT extension

8 CODESYS V3 Development Environment

8.1 Installing CODESYS on the Project Engineering PC

	HINWEIS
<i>For development, only use the CODESYS version that matches the released runtime version of the controller. The version is located on the device housing and in the web interface.</i>	

CODESYS is a device-independent system for programming control units. It conforms to standard IEC 61131-3 and supports all standardised IEC programming languages plus the integration of C code routines and object-orientated programming.

In conjunction with runtime system CODESYS Control Win V3 it also allows the use of "multi-device" and "multi-application" programs. Owing to its component-based architecture, it supports customer-specific configurations of and extensions to the user interface.

Before installing CODESYS, please read and take note of the system requirements.

System requirements

Operating system

Windows 8 / 10 (32/64 Bit)

The versions maintained by Microsoft are supported.

Recommended system properties

2.5 GHz processor

8 GB RAM

12 GB free hard disk space

Additional requirements

Microsoft Internet Explorer 11, or higher

Note

No license needed

Please note the license agreement with CODESYS Group

The development environment can be downloaded in different versions from the CODESYS Store.



8.2 Preparing CODESYS

8.2.1 Device Description in CODESYS V3

Before the IEC 61131-3 development tool can be used to operate a device, CODESYS V3 is to be made known to the device as the runtime system.

A separate plug-in, the Device Repository, provides the local system and your projects with the device definition management functions. Among other features, it contains commands of category Devices which you will normally find in the Tools menu.

- Open the Tools menu and pick Device Repository...
- Screen Device Repository is displayed.
- Expand the tree at node Control Units (PLC).

The Device Repository hosts the descriptions of all devices currently installed on the local system and makes the devices available for CODESYS programming. Devices are installed in and uninstalled directly from the Device Repository.

Screen Device Descriptions Installed displays the Name, Vendor and Version of every device that is currently installed. Click on the plus and minus signs to expand or collapse the branches.

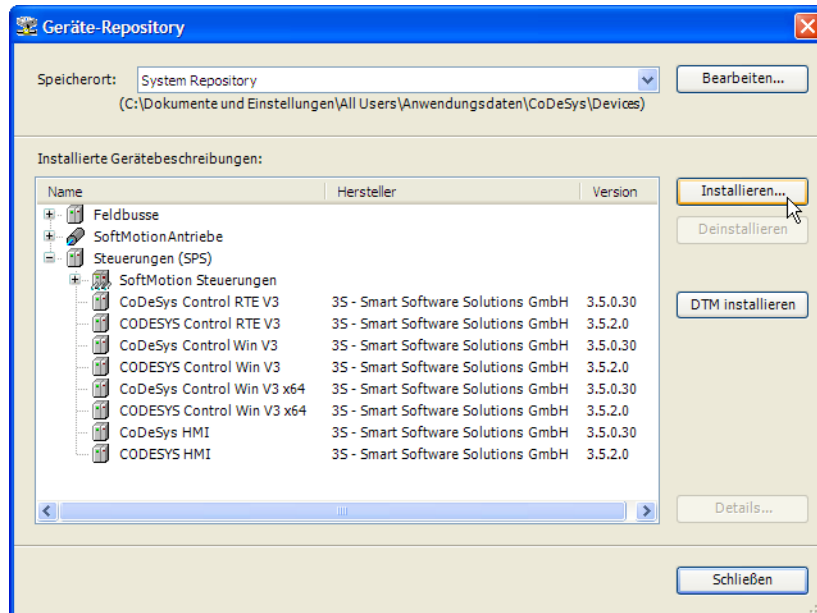

Device description

All Scout variants equipped with an iMX6 processor system use Device Description "ContollerES6". Run the Web Configurator and open its Download menu to load this Device Description and the one for the integrated optional 4DI/4DO from the unit.

Variant	Device Id	Device Name
Scout XX6	64	ControllerES6
Optional internal 4DI/4DO	1064	ControllerES6IO

To install a device description

Click on Install... to install a new device on the local system and make it available for use in the programming system.

Screen Install Device Description is displayed to let you search the system for the associated device description file. If you are looking for a standard device, set the file type filter to "*.devdesc.xml" (device description). Another option is to find vendor-specific description files such as *gsd files of Profibus DP modules or *.eds and *.dcf files of CAN devices.

Clicking on OK confirms your settings, closes the screen and adds the device to the tree shown on screen Device Repository. Look at the bottom of screen Device Repository to find messages on any installation error (e.g. missing files referenced by the device description).

To download a Device Description

The matching Device Description is stored on the device. Display the web configuration page and open the Downloads menu to load it.

On the web configuration screen, go to tab Download and tap on Download DevDescr.

EtherCAT Konfiguration

General Autoconfig master/slaves **EtherCAT** 

EtherCAT NIC Settings

Destination address (MAC) Broadcast Redundancy

Source address (MAC)

Network name

Select network by MAC Select network by name

Select Network Adapter

MAC address	Name	Description
0005510D1760	eth0	
F2BA509184B5	eth1	

9 Appendix

9.1 Software Copyrights

The unit's software contains product components of third-party software makers. This section summarises the copyright details regarding the software resources concerned.

CODESYS Control runtime system

Equipment manufacturers installing the CODESYS runtime system on their devices are sent a licence file when they purchase the [CODESYS Control Runtime Toolkit](#). Licence fees have to be paid for every CODESYS-programmable device ("Runtime Royalties"). To show that a device is licensed, the equipment manufacturer is given a certificate for the toolkit and any optional add-ons.

9.2 Software References

9.3 Wiring Example

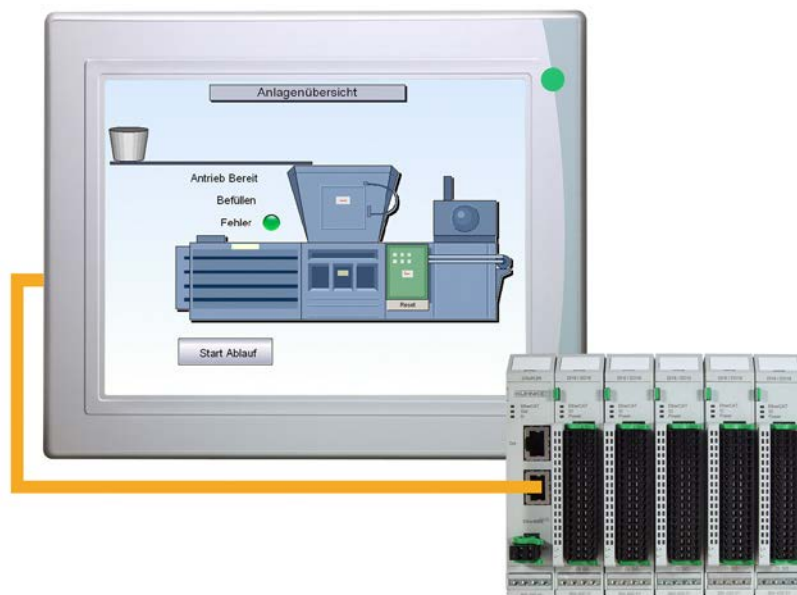

9.4 Dimensions

Scout 706/726

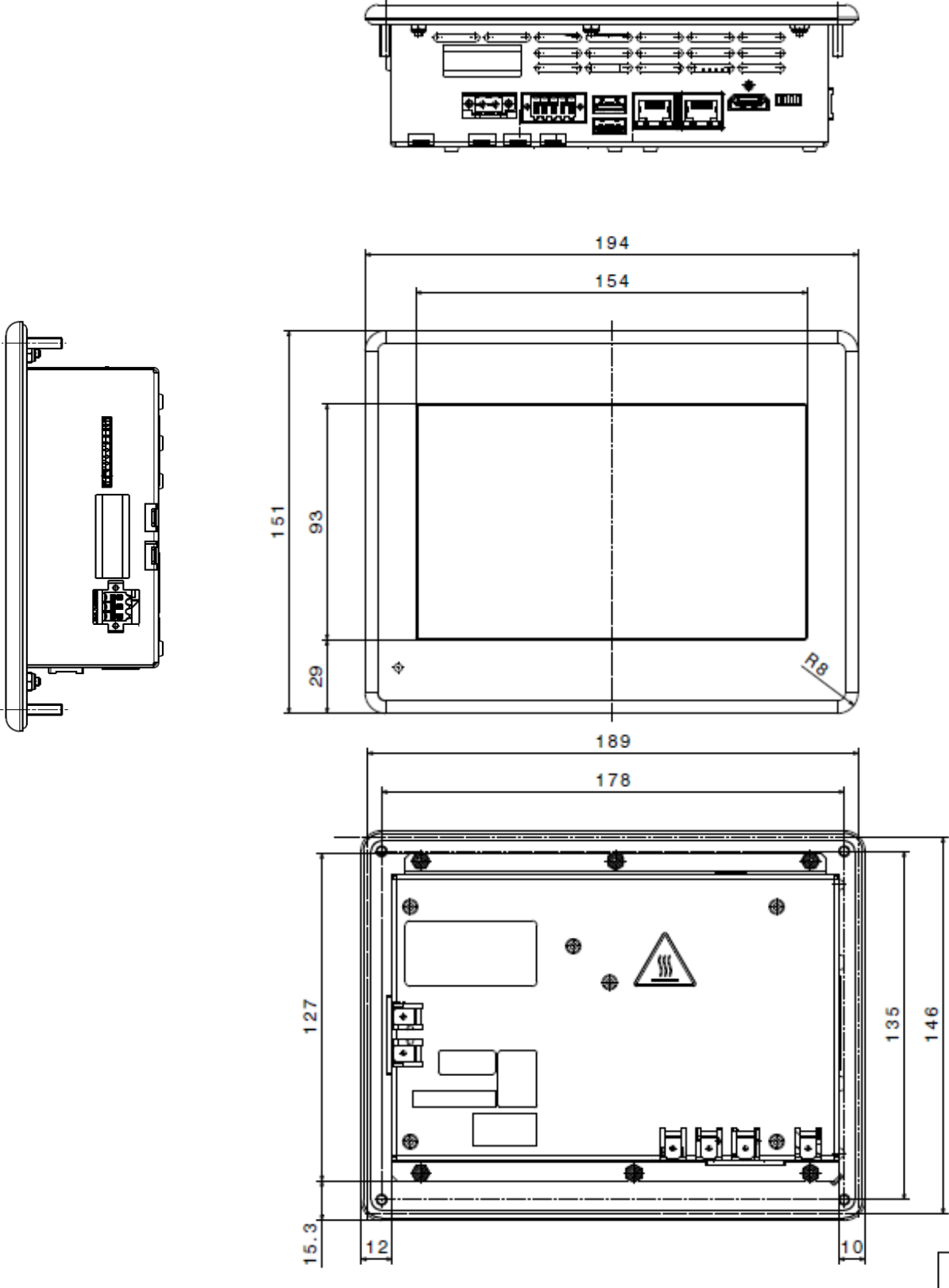

Scout 706 ET / 726 ET

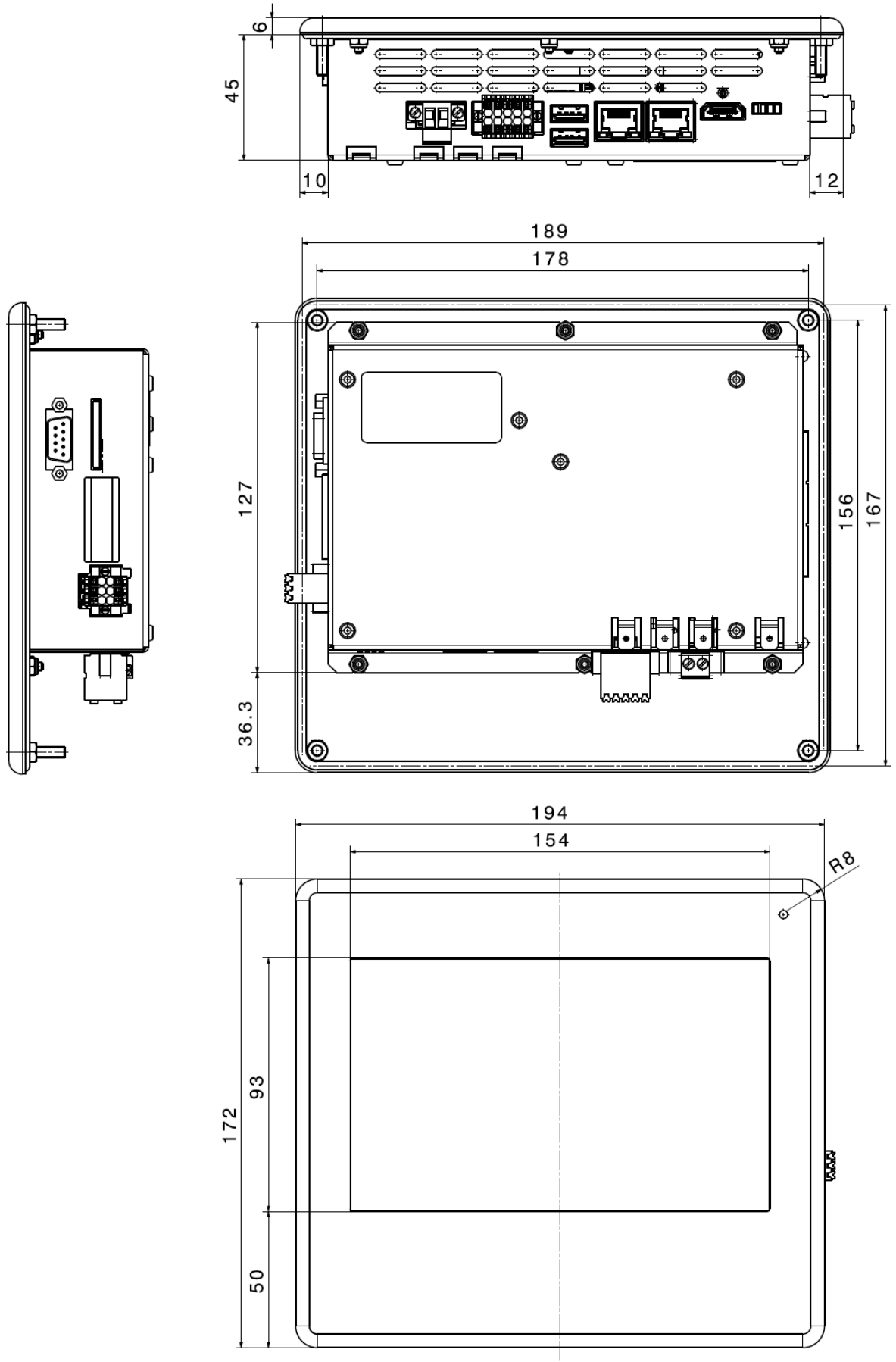

Scout 1006 / 1026

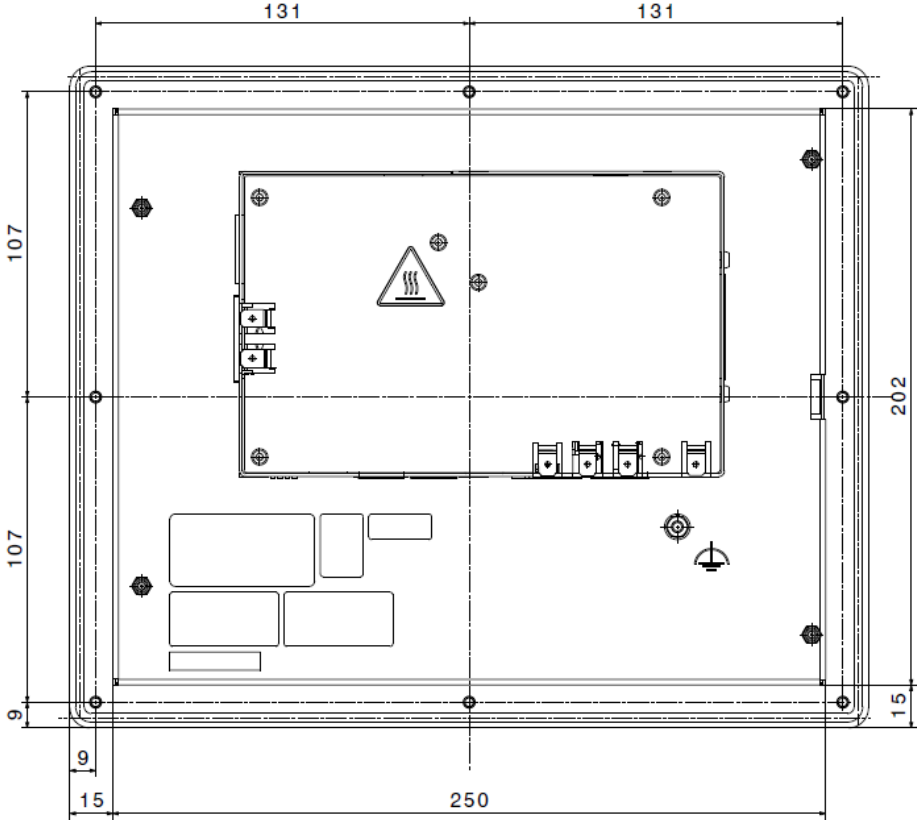
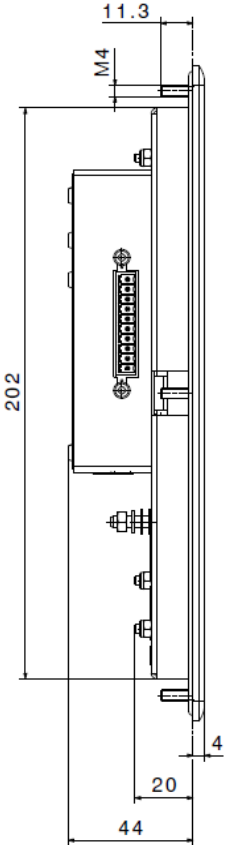
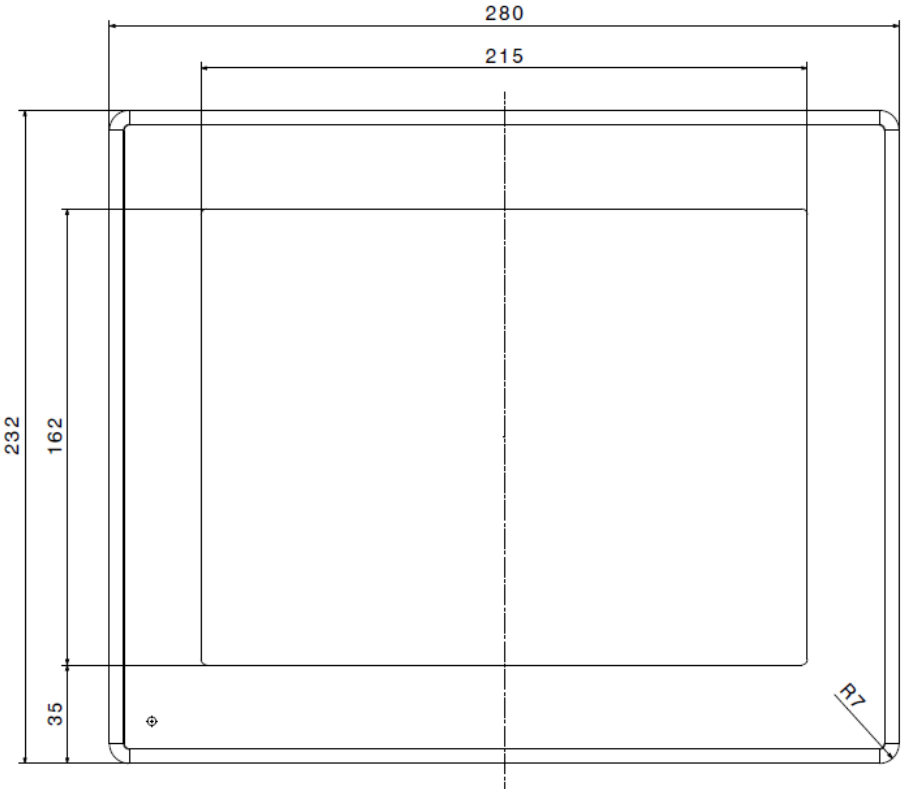

Scout 1206 / 1226

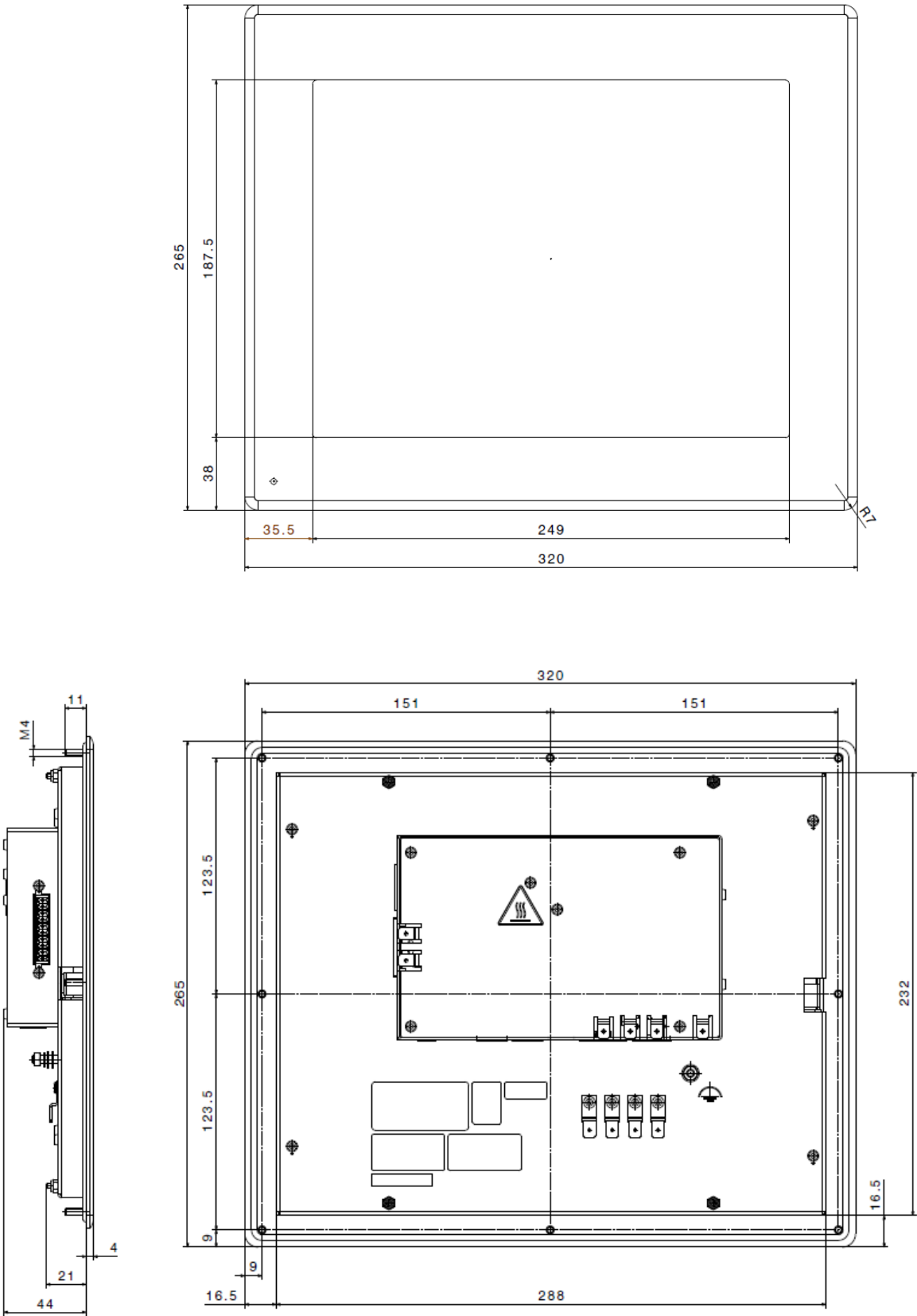

9.5 Chemical Resistance

Resistive Touch Screen

The uninterrupted layer of front polyester film is highly resistant to abrasion and provides excellent chemical resistance to cleaning agents and solvents.

The front film complies with DIN 42 115 Part 2 and withstands the following chemicals

- Ketones
- Esters
- Alcohols
- Aromatic hydrocarbons
- Chlorinated hydrocarbons
- Organic acids
- Mineral acids (dilution)
- Bases (diluted)
- Oils and greases
- Food products
- Household cleaners

	Information
	<p><i>The front film will not resist the following chemicals and influences:</i></p> <ul style="list-style-type: none">▪ Benzoyl alcohol▪ Concentrated bases▪ Concentrated mineral acids▪ Methylene chloride <p><i>For details please contact the product management of Kendrion Kuhnke Automation GmbH.</i></p>

9.6 Applicable Standards and Limits

9.6.1 Safety Standards and Directives

- EN 61131-2:2008
Programmable logic controllers – Part 2: Equipment requirements and tests

9.6.2 EMC Standards

EMC immunity to:

- Generic standard DIN EN 61000-6-2:2011-06
Electromagnetic Compatibility (EMC) - Part 6-2: Generic standards - Immunity for industrial environments
- Product standard DIN EN 61131-2:2008-04
Programmable logic controllers – Part 2: Equipment requirements and tests

EMC noise emission to:

- Generic standard DIN EN 61000-6-4:2007
Electromagnetic Compatibility (EMC) - Part 6-4: Generic standards - Emission standard for industrial environments
- Product standard DIN EN 61131-2:2008-04
Programmable logic controllers – Part 2: Equipment requirements and tests

9.6.3 Admissible Ambient Conditions

Storage and transport

Temperature	-25°C to +70°C
Relative humidity	5% to 95% at 25°C (non-condensing)
Vibration	5 Hz to 9 Hz: +/-3.5 mm, 9 to 150 Hz: 9.8 m/ s ² (1g)
Shock.....	150 m/s ² , 11 ms (15g)

Operation

Location of use	For indoor use only; front panel withstands wet environments
Altitude	max. 2000m
Ambient temperature.....	Vertical installation: 0°C to 55°C
Relative humidity	5% to 95% at 25°C (non-condensing)
Vibration	5 Hz to 9 Hz: +/-3.5 mm, 9 to 150 Hz: 9.8 m/ s ² (1g)
Shock.....	150 m/s ² , 11 ms (15g)

9.7 Regulations and Declarations

9.7.1 Mark of Conformity

The EC-Declarations of Conformity and the associated documentation can be made available to the competent authorities pursuant to the above EU Directive. Please contact the Project Management, as necessary.



9.8 Approvals

The Scout 06-series of units has been granted the following approvals:

RoHS ✓

Conforms to RoHS Directive 2011/65/EU and Directive 2015/863/EU derived from it limiting the use of certain hazardous substances in electrical and electronic equipment

Applicable exceptions pursuant to EU Directive 2011/65/EU Annex III, 6 a – c

9.9 Order Specifications

9.9.1 Basic Units

Technical Data

Scout 706 V3 TV WV

HMI Panel PLC
 7" display, resolution 800x480 (WVGA)
 CPU Freescale i.MX6X Solo, 800 MHz
 Operating system: Windows Embedded Compact 2013
 CODESYS V3 Soft SPS, CODESYS TargetVisu, CODESYS WebVisu
 EtherCAT, CANopen, remanent buffer memory
 Power supply unit rated for control purposes, 24 V DC (-20%...+25%)



Scout 1006 V3 TV WV

HMI Panel PLC
 10.4" display, resolution 600x480 (VGA)
 CPU Freescale i.MX6X Solo, 800 MHz
 Operating system: Windows Embedded Compact 2013
 CODESYS V3 Soft SPS, CODESYS TargetVisu, CODESYS WebVisu
 EtherCAT, CANopen, remanent buffer memory
 Power supply unit rated for control purposes, 24 V DC (-20%...+25%)



Scout 1206 V3 TV WV

HMI Panel PLC
 12.1" display, resolution 800x600 (SVGA)
 CPU Freescale i.MX6X Solo, 800 MHz
 Operating system: Windows Embedded Compact 2013
 CODESYS V3 Soft SPS, CODESYS TargetVisu, CODESYS WebVisu
 EtherCAT, CANopen
 Remanent buffer
 Power supply unit rated for control purposes, 24 V DC (-20%...+25%)



Econo 206 V3 WV

Compact PLC
 CPU Freescale i.MX6X Solo, 800 MHz
 Operating system: Windows Embedded Compact 2013
 CODESYS V3 Soft SPS, CODESYS TargetVisu, CODESYS WebVisu
 EtherCAT, CANopen, remanent buffer memory
 Power supply unit rated for control purposes, 24 V DC (-20%...+25%)



9.9.2 Order code

640 Series																
.																
2 = PLC Baseboard																
nn = 00 Econo without display nn = 07 Scout 7" nn = 10 Scout 10" nn = 12 Scout 12"																
.																
a = 0 Compact PLC Econo a = 1 Panel PLC Scout a = 2 Compact PLC Econo DIN rail mount																
b = 0																
c = 7 Single Core CPU c = 9 Quad Core CPU																
.																
d = 0 without IO Extension d = 1 with IO Extension 4DI / 4DO																
e = 0 without Softmotion e = 1 with Softmotion e = 2 with Softmotion CNC & Robotics																
f = 0 without visualization f = 1 with target visualization f = 2 with web visualization f = 3 with target- and web visualization																
.																
g = 1 Single Core License g = 4 Quad Core License																
h = 0																
i = 0																
640	.	2	nn	.	a	b	c	.	d	e	f	.	g	h	i	
640	.	2		.		0		.				.		0	0	

9.9.3 Accessories

Kendrion Kuhnke Automation GmbH
Industrial Control Systems

Lütjenburger Str. 101
D-23714 Malente

Tel.: +49 4523 402 0
Fax: +49 4523 402 201

sales-ics@kendrion.com
www.kendrion.com