

Kuhnke Electronics Instruction Manual Ventura FIO IP20 EtherCAT I/O Modules

E 747 GB 17/03/2021 101.008.59 - 16/03



This technical information is directed primarily to specialists involved in the conception, design and construction of machines. It does not indicate any information about availability of products. The technical specifications stated herein are only of descriptive nature and do not represent a guarantee as to the ability or usability of a product in a legal sense. Such specific assurances are subject to individual contractual agreements. We do not accept any claims for compensation of damages for whatever reason, unless substantial proof of intention or gross negligence is provided. Complete or partial reproduction of this document requires the written consent of the author. All rights concerning changes, omissions and misconceptions are reserved. Illustrations similar.

Microsoft® Windows® and the Windows logo are registered trademarks of Microsoft Corporation in the USA and other countries.

EtherCAT® is a registered trademark and patented technology, licensed from Beckhoff Automation GmbH, Germany.

Additional information on the PLCopen organization can be found at www.plcopen.org.

CiA® and CANopen® are registered community trade marks of CAN in Automation e.V. All rights reserved by the individual copyright holders.

Reproduction even of extracts only with the editor's express and written prior consent.

Table of Contents

1	Introduction	7
1.1	EtherCAT® — Ethernet Control Automation Technology	7
1.2	Ventura — the automation platform	7
1.3	Ventura FIO — Ventura Fast Input Output	7
2	Reliability, Safety	9
2.1	Intended Use	9
2.2	Target Group	9
2.3	Reliability	9
2.4	Symbols	9
2.4.1	Danger	9
2.4.2	Attention	10
2.4.3	Note	10
2.4.4	Under Construction	10
2.4.5	Instruction	10
2.5	Safety	11
2.5.1	Project Planning and Installation	11
2.5.2	Maintenance and Servicing	11
2.6	Electromagnetic Compatibility	12
2.6.1	Definition	12
2.6.2	Interference Emission	12
2.6.3	General Notes on Installation	12
2.6.4	Electrical Immission Safeguard	12
2.6.5	Cable Routing and Wiring	13
2.6.6	Location of Installation	13
2.6.7	Particular Sources of Interference	13
3	System Description	14
3.1	Mechanical Design	14
3.1.1	Earth	15
3.1.2	Installation	16
3.2	System power supply	17
3.2.1	General	17
3.2.2	Bus coupler	17
3.2.3	I/O modules	17
3.3	Status LEDs	19
3.3.1	"EtherCAT Run" LED	19
3.3.2	"In L/A" LED, "Out L/A" LED	19
3.3.3	"IO" LED	19
3.3.4	"Power" LED	19
4	Modules	20
4.1	Bus Coupler	20
4.1.1	Terminals	20
4.1.2	Status LEDs	20
4.1.3	Function	21
4.1.4	Technical data	21
4.2	D8/DO8	22
4.2.1	Terminals	22
4.2.2	Status LEDs	22
4.2.3	Function	23
4.2.4	Technical data	23
E	747 GB	3

Table of Contents

4.3	DI16/DO16	24
4.3.1	Terminals.....	24
4.3.2	Status LEDs	24
4.3.3	Function.....	25
4.3.4	Technical data	25
4.4	DI16/DO8	26
4.4.1	Terminals.....	26
4.4.2	Status LEDs	26
4.4.3	Function.....	27
4.4.4	Technical data	27
4.5	DI16/DO16 LS (Low-side).....	28
4.5.1	Terminals.....	28
4.5.2	Status LEDs	28
4.5.3	Function.....	29
4.5.4	Technical data	29
4.6	DI32.....	30
4.6.1	Terminals.....	30
4.6.2	Status LEDs	30
4.6.3	Function.....	31
4.6.4	Technical data	31
4.7	DI16.....	32
4.7.1	Terminals.....	32
4.7.2	Status LEDs	32
4.7.3	Function.....	33
4.7.4	Technical data	33
4.8	DO16.....	34
4.8.1	Terminals.....	34
4.8.2	Status LEDs	34
4.8.3	Function.....	35
4.8.4	Technical data	35
4.9	DO8.....	36
4.9.1	Terminals.....	36
4.9.2	Status LEDs	36
4.9.3	Function.....	37
4.9.4	Technical data	37
4.10	AI4-I.....	38
4.10.1	Terminals.....	38
4.10.2	Status LEDs	38
4.10.3	Function.....	39
4.10.4	Technical data	43
4.11	AI8-I.....	44
4.11.1	Terminals.....	44
4.11.2	Status LEDs	44
4.11.3	Function.....	45
4.11.4	Technical data	49
4.12	AI4/8-U	50
4.12.1	Terminals.....	50
4.12.2	Status LEDs	50
4.12.3	Function.....	51
4.12.4	Technical data	54

4.13	AI8/16-U	55
4.13.1	Terminals.....	55
4.13.2	Status LEDs	55
4.13.3	Function.....	56
4.13.4	Technical data	59
4.14	AO4-U/I.....	60
4.14.1	Terminals.....	60
4.14.2	Status LEDs	60
4.14.3	Function.....	61
4.14.4	Technical data	63
4.15	AI4-Pt/Ni100, AI4-Pt/Ni1000.....	64
4.15.1	Terminals.....	64
4.15.2	Status LEDs	65
4.15.3	Function.....	66
4.15.4	Technical data	69
4.16	AI8-Pt/Ni100, AI8-Pt/Ni1000.....	70
4.16.1	Terminals.....	70
4.16.2	Status LEDs	71
4.16.3	Function.....	72
4.16.4	Technical data	75
4.17	AI4-Thermo element.....	76
4.17.1	Terminals.....	76
4.17.2	Status LEDs	76
4.17.3	Function.....	77
4.17.4	Technical data	80
4.18	AI8-Thermo element.....	81
4.18.1	Terminals.....	81
4.18.2	Status LEDs	81
4.18.3	Function.....	82
4.18.4	Technical data	85
4.19	RS232 1 Port	86
4.19.1	Terminals.....	86
4.19.2	Status LEDs	86
4.19.3	Function.....	87
4.19.4	Technical Data	94
4.20	PROFIBUS-DP-Slave.....	95
4.20.1	Terminals.....	95
4.20.2	Status LEDs	95
4.20.3	Function.....	96
4.20.4	Technical Data	102
4.21	CounterPosi2 5V, Counter2 5V	103
4.21.1	Terminals.....	103
4.21.2	Status LEDs	104
4.21.3	Function.....	105
4.21.4	Examples.....	114
4.21.5	Technical Data	119
4.22	Extender 2 Port.....	120
4.22.1	Terminals.....	120
4.22.2	Status LEDs	121
4.22.3	Function.....	121

Table of Contents

4.22.4 Configuration example	122
4.22.5 Technical Data	125
4.23 MIX 02	126
4.23.1 Terminals.....	126
4.23.2 Status LED	127
4.23.3 Function (CoE-variant)	128
4.23.4 Technical Data	135
5 Supplement	136
5.1 Potential Distributor 2 x 16.....	136
5.1.1 Terminals.....	136
5.1.2 Status LEDs	136
5.1.3 Function.....	136
5.1.4 . Technical Data	136
5.2 Shield connection terminal block	137
5.2.1 Terminals.....	137
5.2.2 Function.....	137
5.2.3 . Technical Data	137
6 Configuration	138
6.1 Offline configuration	138
6.2 Online configuration	141
7 Appendix.....	142
7.1 Technical data.....	142
7.1.1 Ventura FIO system properties	142
7.1.2 Ventura FIO bus coupler	142
7.1.3 Ventura FIO I/O modules	142
7.2 Order specifications	147
7.2.1 Ventura FIO Modules	147
7.2.2 Ventura FIO Supplement	148
7.3 References.....	150
7.4 Sales & Service.....	151
7.4.1 Main factory in Malente	151
7.4.2 Customer service	151
7.5 Index	152

1 Introduction

1.1 EtherCAT®¹ — Ethernet Control Automation Technology

EtherCAT is the most powerful Ethernet-based fieldbus system currently available on the market. EtherCAT puts up the top speed mark, and its flexible topology and simple configuration make it the perfect means of controlling extremely fast processes. To give you a clue: 1000 I/Os can be addressed in 30 μ s.

Because of its high performance, the simple wiring and its open protocol support, EtherCAT is often used as a fast motion control and I/O bus driven by an industrial PC or in conjunction with control technology on a smaller scale. EtherCAT moves beyond the limits of conventional fieldbus systems. Its interconnections between the controller at one end and both the I/O modules and drives at the other are as fast as those of a backplane bus. EtherCAT controllers thus nearly act like centralised control systems, overcoming the issue of bus transfer times that conventional fieldbus systems are burdened with.

1.2 Ventura — the automation platform

The Ventura automation platform has been specifically engineered with applications near to the machine in mind. Ventura provides flexible automation solutions including hardware and software PLCs based around industrial PCs, remote I/Os, remote PLCs and decentralised drives. EtherCAT, PRO-FIBUS-DP, CANopen and AS interface are supported for networking.

Ventura industrial PCs used as EtherCAT masters feature hard-coded realtime response and a CoDeSys PLC.

1.3 Ventura FIO — Ventura Fast Input Output

Ventura FIO is a system of I/O modules for connecting the process signals to an EtherCAT network.

Ventura FIO consists of the Ventura FIO bus coupler and a range of Ventura FIO I/O modules.

The Ventura FIO bus coupler converts the physical transfer technology (twisted pair) to LVDS (E-bus) and generates the system voltages required by the LVDS modules. The standard 100 Base Tx lines used for office network communications connect to the one side, the Ventura FIO I/O modules for the process signals connect to the other. This is how the Ethernet EtherCAT protocol is retained right through to the last I/O module. At the end of the modular device, the connection between the forward and return lines is automatically closed, the effect being that another 100 Base Tx line can be plugged in to connect the next EtherCAT unit to the second bus coupler port.

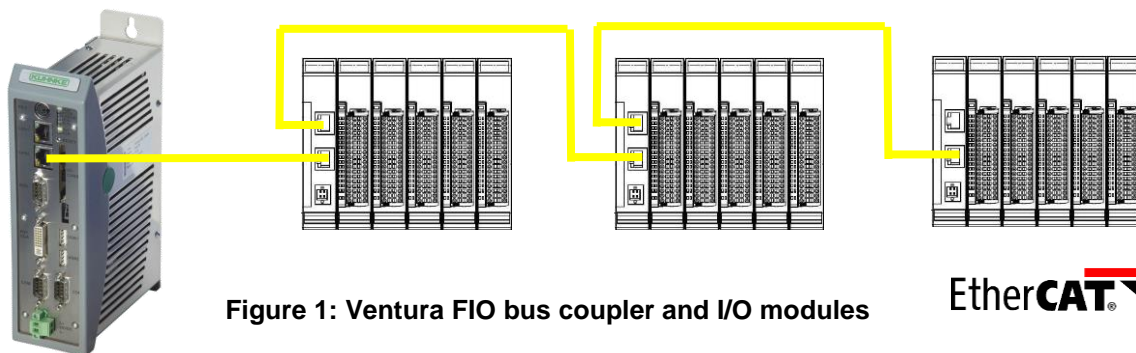

Figure 1: Ventura FIO bus coupler and I/O modules

¹ EtherCAT® is a registered trade mark and a patented technology of Beckhoff Automation GmbH, Germany.

2 Reliability, Safety

2.1 Intended Use

Kuhnke products are designed as resources for use in industrial environments.

All other applications need to be discussed with the factory first. The manufacturer shall neither be liable for any other than the intended use of our products nor for any ensuing damages. The risk shall be borne by the operator alone. The use as intended includes that you read and apply all information and instructions contained in this manual.

2.2 Target Group

This instruction manual contains all information necessary for the use of the described product (control device, control terminal, software, etc.) according to instructions. It is written for design, project planning, servicing and commissioning experts. For proper understanding and error-free application of technical descriptions, instructions for use and particularly of notes of danger and warning, extensive knowledge of automation technology is compulsory.

2.3 Reliability

Reliability of Kuhnke products is brought to the highest possible standards by extensive and cost-effective means in their design and manufacture. These include:

- selecting high-quality components,
- quality agreements with our suppliers,
- actions to avoid static charges when handling MOS circuits,
- worst case planning and design of all circuits,
- inspections at various stages of fabrication,
- computer-aided tests of all assemblies and their interaction in the circuit,
- statistical assessment of the quality of fabrication and of all returned goods for the immediate taking of appropriate corrective actions.

2.4 Symbols

Despite the actions described in section 2.3, the occurrence of faults or errors in electronic control units - even if most highly improbable - must be taken into consideration.

Please pay particular attention to the additional notices which we have marked by symbols throughout this instruction manual. While some of these notices make you aware of possible dangers, others are intended as a means of orientation. They are described further down below in descending order of importance.

2.4.1 Danger



This symbol warns you of dangers which may cause death or grievous bodily harm if operators fail to implement the precautions described.

2.4.2 Attention



This symbol draws your attention to information you must take a look at to avoid malfunctions, possible material damage or dangerous states.

2.4.3 Note



This symbol draws your attention to additional information concerning the use of the described product. It may also cross-reference you to information to be found elsewhere (e.g. in other manuals).

2.4.4 Under Construction



This symbol tells you that the function described was not or not fully available at the time this document went to press.

2.4.5 Instruction



Wherever you see these symbols in the left margin, you will find a list of steps instructing you to take the appropriate computer or hardware actions. They are intended as a means of orientation wherever working steps and background information alternate (e.g. in tutorials).



2.5 Safety

Our products normally become part of larger systems or installations. The information below is intended to help you integrate the product into its environment without dangers to humans or material/equipment.



To achieve a high degree of conceptual safety in planning and installing an electronic controller, it is essential to exactly follow the instructions given in the manual because wrong handling could lead to rendering measures against dangers ineffective or to creating additional dangers.

2.5.1 Project Planning and Installation

- 24 VDC power supply: generate as electrically safely separated low voltage. Suitable devices are, for example, split transformers constructed in compliance with European Standard EN 60742 (corresponds to VDE 0551).
- Power breakdowns or power fades: the program structure is to ensure that a defined state at restart excludes all dangerous states.
- Emergency switch-off installations must comply with EN 60204/IEC 204 (VDE 0113). They must be effective at any time.
- Safety and precautions regulations for qualified applications have to be complied with.
- Please pay particular attention to the notices of warning which, at relevant places, will make you aware of possible sources of dangerous mistakes or faults.
- Relevant standards and VDE regulations are to be complied with in every case.
- Control elements are to be installed in such a way as to exclude unintended operation.
- Lay control cables such that interference (inductive or capacitive) is excluded if this interference could influence controller operation or its functionality.

2.5.2 Maintenance and Servicing

- Precautions regulation BGV A3 must be observed when measuring or checking a controller in a power-up condition. This applies to section 8 (Admissible deviations when working on parts) in particular.
- Repairs must be carried out by specially trained Kuhnke staff only (usually in the main factory in Malente). Warranty expires in every other case.
- Spare parts:
- Only use parts approved of by Kuhnke. Only genuine Kuhnke modules must be used in modular controllers.
- Modular systems: always plug or unplug modules in a power-down state. You might otherwise damage the modules or (possibly not immediately recognisably!) inhibit their functionality.
- Always dispose of any batteries and accumulators as hazardous waste.

2.6 Electromagnetic Compatibility

2.6.1 Definition

Electromagnetic compatibility is the ability of a device to function satisfactorily in its electromagnetic environment without itself causing any electromagnetic interference that would be intolerable to other devices in this environment.

Of all known phenomena of electromagnetic noise, only a certain range occurs at the location of a given device. It is defined in the relevant product standards.

The design and immunity to interference of programmable logic controllers are internationally governed by standard IEC 61131-2 which, in Europe, has been the basis for European Standard EN 61131-2.



Refer to IEC 61131-4, User's Guideline, for general installation instructions to be complied with to ensure that hardware interface factors and the ensuing noise voltages are limited to tolerable levels.

2.6.2 Interference Emission

Interfering emission of electromagnetic fields, HF compliant to EN 55011, limiting value class A, Group 1



If the controller is designed for use in residential areas, high-frequency emissions must comply with limiting value class B as described in EN 55011. Fitting the controller into earthed metal cabinets and installing filters in the supply lines may produce a shielding compliant to the above standard.

2.6.3 General Notes on Installation

As component parts of machines, facilities and systems, electronic control systems must comply with valid rules and regulations, depending on their field of application.

General requirements concerning the electrical equipment of machines and aiming at the safety of these machines are contained in Part 1 of European Standard EN 60204 (same as VDE 0113).



For safe installation of our control system please observe the information contained in the next chapters (→ 2.6.4 ff).

2.6.4 Electrical Immission Safeguard

Connect the control system to the protective earth conductor to eliminate electromagnetic interference. Practice best cable routing.

2.6.5 Cable Routing and Wiring

Keep power circuits separate from control circuits:

- DC voltages 60 V ... 400 V
- AC voltages 25 V ... 400 V

Joint laying of control circuits is allowed for:

- shielded data signals
- shielded analogue signals
- unshielded digital I/O lines
- unshielded DC voltages < 60 V
- unshielded AC voltages < 25 V

2.6.6 Location of Installation

Exclude any and all impediments due to temperature, dirt, impact, vibration or electromagnetic interference.

2.6.6.1 Temperature

Consider heat sources such as general heating of rooms, sunlight, heat accumulation in assembly rooms or control cabinets..

2.6.6.2 Contamination

Use suitable casings to avoid possible negative influences due to humidity, corrosive gas, liquid or conducting dust.

2.6.6.3 Impact and Vibration

Consider possible influences caused by motors, compressors, transfer lines, presses, ramming machines and vehicles.

2.6.6.4 Electromagnetic Interference

Consider electromagnetic interference from various local sources: motors, switching devices, switching thyristors, radio-controlled devices, welding equipment, arcing, switched-mode power supplies, converters / inverters.

2.6.7 Particular Sources of Interference

2.6.7.1 Inductive Actuators

Switching off inductances (such as from relays, contactors, solenoids or switching magnets) produces surge voltages. It is necessary to reduce these extra voltages to a minimum.

Reducing elements may be diodes, Z-diodes, varistors or RC elements. To find the best adapted elements, we recommend that you contact the manufacturer or supplier of the corresponding actuators for the relevant information.

3 System Description

Ventura FIO is a system of I/O modules for connecting the process signals to any EtherCAT network station.

Ventura FIO consists of the Ventura FIO bus coupler and a range of Ventura FIO I/O modules.

The Ventura FIO bus coupler converts the physical transfer technology (twisted pair) to LVDS (E-bus) and generates the system voltages required by the LVDS modules. The standard 100 Base Tx lines used for office network communications connect to the one side, the Ventura FIO I/O modules for the process signals connect to the other. This is how the Ethernet EtherCAT protocol is retained right through to the last I/O module. At the end of the modular device, the connection between the forward and return lines is automatically closed, the effect being that another 100 Base Tx line can be plugged in to connect the next EtherCAT unit to the second bus coupler port. If the bus coupler is the last station of the EtherCAT network, i.e. if its RJ45 "Out" socket remains unplugged, the connection between the forward and return lines is automatically closed,

3.1 Mechanical Design

For the basic layout of the Ventura FIO modules see Figure 2.

The bus coupler and the I/O modules differ in their connectors and indicators, however.

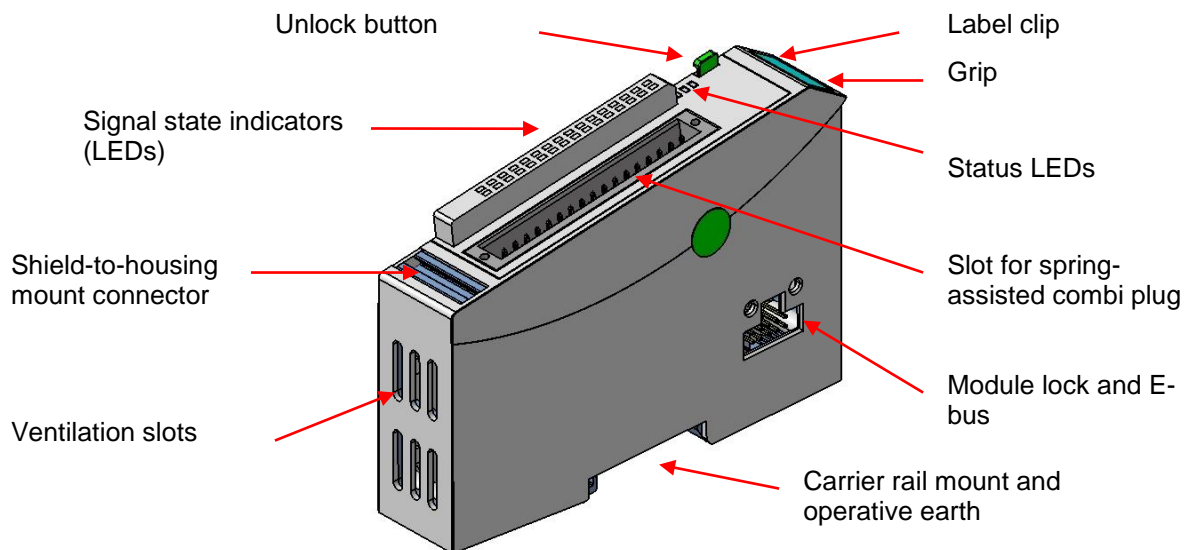

Figure 2: Module layout

The housing mount consists of an aluminium profile with an integral snap-on device used to snap the module to a 35mm DIN rail. The housing trough including the optical fibres for the status indicators, the side face and the front is made of plastic and contains the module. The optical fibres for the signal state indicators (LEDs) are located next to the spring-assisted combi plug. They slightly protrude from the housing and allow a clear diagnosis at a glance.

3.1.1 Earth

Connect the Ventura FIO modules to earth by attaching the metal housing to operative earth.

Since the operative earth connectors dissipates HF currents, it is of utmost importance for the module's noise immunity.

HF interference is dissipated from the electronics board to the metal housing. The metal housing therefore needs to be suitably connected to an operative earth connector.

You will normally have to ensure that

- the connection between module housing and DIN rail conducts well,
- the connection between DIN rail and switching cabinet conducts well,
- the switching cabinet is safely connected to earth.

In special cases you may attach the earth wire straight to the module.

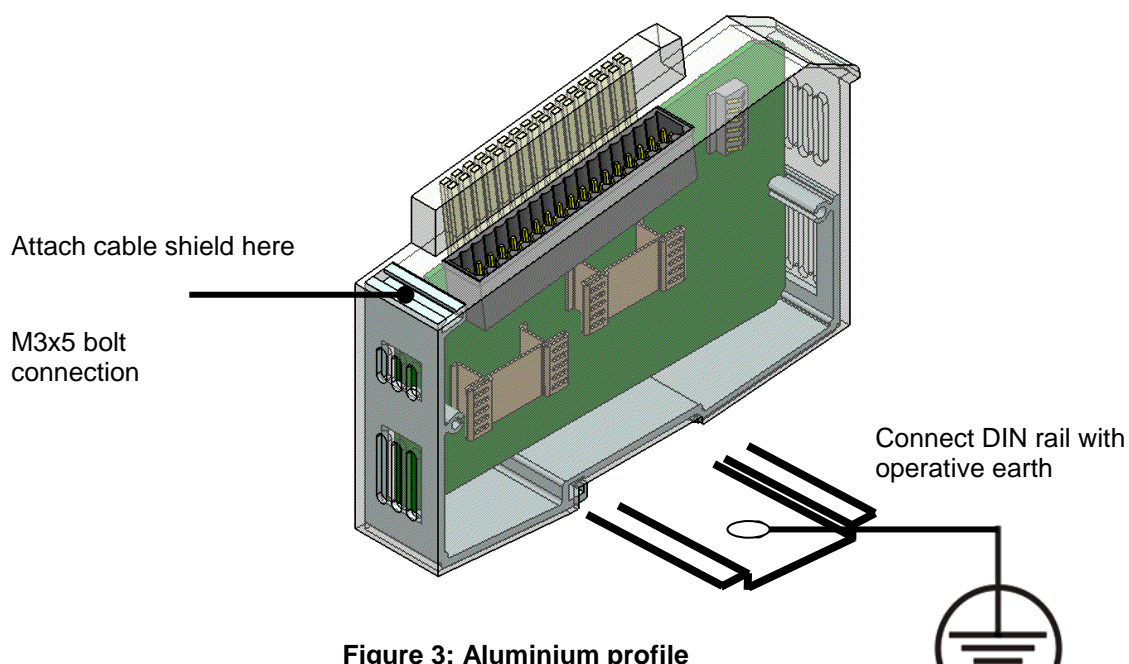

Figure 3: Aluminium profile



Earth wires should be short and have a large surface (copper mesh). Further details has site [http://en.wikipedia.org/wiki/Ground_\(electricity\)](http://en.wikipedia.org/wiki/Ground_(electricity))

3.1.2 Installation

The Ventura FIO modules are intended for mounting rail installation (DIN EN 50022, 35 x 7.5 mm).

3.1.2.1 To snap on a single module

1. Push up the module against the mounting rail from below, allowing the metal spring to snap in between mounting rail and mounting area as illustrated.
2. Push the module against the mounting wall until it snaps in.

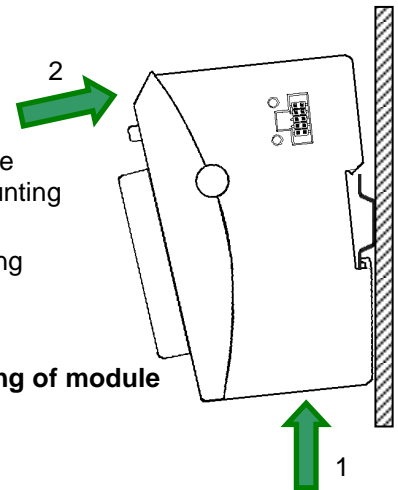

Figure 4: Rail mounting of module

3.1.2.2 To interconnect two modules

- After snapping on the first module to the rail, snap on the second module about 1cm away towards the right of the first module.
- Push the second module along the rail towards the first module until you hear the locking device snap in.

3.1.2.3 To disconnect two modules

- Push down the unlock button (see Figure 5) of the module that you wish to disconnect from the module to the left of it.
- Push both module away from one another until they are about 1 cm apart.

3.1.2.4 To take down a single module

1. Push the module up and against the metal spring located on the underside of the rail guide.
2. Tip the module away from the rail as shown in the illustration.
3. Pull the module down and out of the mounting rail.

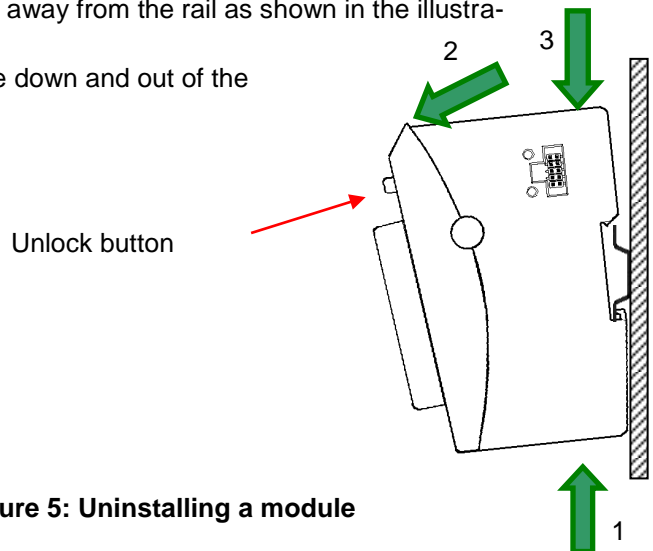

Figure 5: Uninstaling a module

3.2 System power supply

3.2.1 General

General Spring-assisted blocks of sockets allow fast and simple wiring. A multiple socket connector densely packs the wires on a small footprint. Use the release latch to easily disconnect the wires where there is little space.

Tool: 0.4 x 2.5 blade screwdriver

Cores: 0.20 - 1.0 mm² (IEC) / 28 - 18 ENC (UL)

Rated current: 5 A (CSA) / 10 A (UL)



Do not connect the power supply lines through from one Ventura Remote I/O power supply port to the next. To ensure that there is as little interference as possible, install a central power supply point and establish a star topology of as short wires as possible between the central point and Ventura Remote I/O.

3.2.2 Bus coupler

The system power supply connects to the bus coupler through a 2-pole plug-type terminal block. Since the bus coupler supplies power to both the E-bus and the logic circuits of the I/O modules, its power consumption depends on the number of I/O modules connected.

Power to the I/O module outputs is supplied separately.



Figure 6: Spring-assisted connector and bus coupler release latch

3.2.3 I/O modules

The I/O supply connects to the I/O module, normally together with the I/Os, using plug-type terminal blocks with different numbers of poles.

Power to the I/O module logic circuits is supplied by the bus coupler.

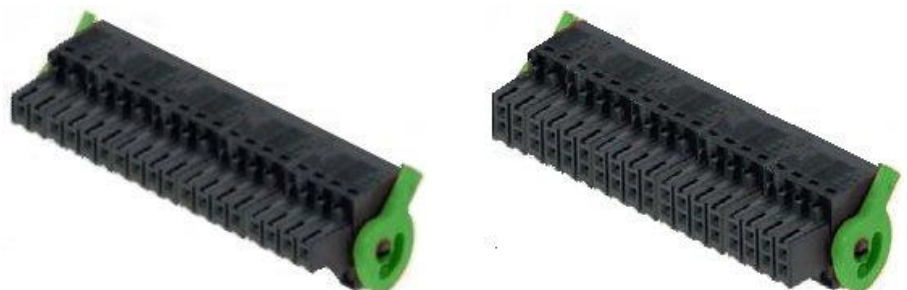

Figure 7: Spring-assisted connector with I/O module release latch



A rapid shut-down of all outputs can be performed by external switch-off of the I/O supply voltage L+. The missing supply voltage is indicated by the power LED. However, not all modules have an undervoltage monitoring, which can report this status to the control unit. If you need the monitoring of the I/O power supply in the control program, connect L+ with a digital input and use it representative for the IO power supply.

Here however, note the following:



Outputs must not be supplied reverse, when the power supply of the outputs is switched.

This is the case if the system continues to be supplied with power.

Outputs that are set forth by the program can be supplied via the protection diode of a reverse supplied output and in this way set the switch off function for these outputs overridden. In addition, the protection diode of the feeding output can be destroyed at high load.

3.3 Status LEDs ¹

3.3.1 "EtherCAT Run" LED

An LED labeled "EtherCAT Run" is located on both the bus coupler and the I/O modules. It indicates the state of the EtherCAT ASIC.

State	LED flash code	Explanation
Init	Off	Initialization, no data exchange
Pre-Op	Off/green, 1:1	Pre-operational, no data exchange
Safe-Op	Off/green, 5:1	Safe operation, inputs readable
Op	Green, on	Operational, unrestricted data exchange

3.3.2 "In L/A" LED, "Out L/A" LED

The "In L/A" and "Out L/A" LEDs are located on the bus coupler. They indicate the physical state of the Ethernets (Link/Activity).

State	LED flash code	Explanation
Not connected	Off	No Ethernet connection
Connected	Green, on	Connected to Ethernet
Traffic	Green, flashing	Exchanging telegrams

3.3.3 "IO" LED

Every I/O module has an LED labeled "IO". It indicates the state of the module's I/Os. Refer to the I/O module sections in this manual to know which states of a module are monitored and indicated.

3.3.4 "Power" LED

An LED labeled "Power" is located on every module that has a power supply connector (e.g. for digital outputs). It indicates the state of the I/O module's I/O power supply.

State	LED flash code	Explanation
On	Green, on	24 VDC supply ok
Off	Off	24 VDC supply not ok

¹ Because of the specification ETG.1300 Indicator and Labeling the following changes have been done beginning at october 2012:

Label old	Label new	LED old	LED new
EtherCAT	EtherCAT Run	Red/Green	Off/Green
In, Out	In L/A, Out L/A		

4 Modules

4.1 Bus Coupler

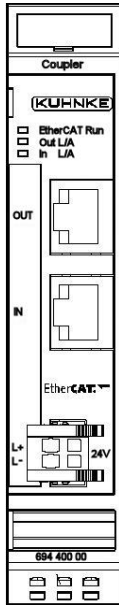

The Ventura FIO bus coupler converts the physical transfer technology (twisted pair) to LVDS (E-bus) and generates the system voltages required by the LVDS modules. The standard 100 Base Tx lines used for office network communications connect to the one side, the Ventura FIO I/O modules for the process signals connect to the other. This is how the Ethernet EtherCAT protocol is retained right through to the last I/O module. At the end of the modular device, the connection between the forward and return lines is automatically closed, the effect being that another 100 Base Tx line can be plugged in to connect the next EtherCAT unit to the second bus coupler port.

Figure 8: Bus coupler front view



*You will get the best results concerning disturbing emission, if you put the shielding of the EtherCAT cable on the function earth.
Use for it e.g. Shield connection terminal block (see chapter 5.2)*

4.1.1 Terminals

Module power supply

L+ 24 VDC
L- 0 V

EtherCAT

IN RJ45 socket input (from previous EtherCAT station)
OUT RJ45 socket output (to next EtherCAT station)

4.1.2 Status LEDs

4.1.2.1 "EtherCAT Run" LED

The LED labeled "EtherCAT Run" indicates the state of the EtherCAT ASIC.

State	LED flash code	Explanation
Init	Off	Initialization, no data exchange
Pre-Op	Off/green, 1:1	Pre-operational, no data exchange
Safe-Op	Off/green, 5:1	Safe operation, inputs readable
Op	Green, on	Operational, unrestricted data exchange

4.1.2.2 "In L/A" LED, "Out L/A" LED

The "In" and "Out" LEDs indicate the physical state of the Ethernet port they are allocated to.

State	LED flash code	Explanation
Not connected	Off	No Ethernet connection
Connected	Green, on	Connected to Ethernet
Traffic	Green, flashing	Exchanging telegrams

4.1.3 Function

See page 20

4.1.3.1 Module state

Variable	Data type	Explanation
Undervoltage	BOOL	Low voltage (supplied power < 19.2V)

4.1.4 Technical data

Function	Connects a 100 Base-TX EtherCAT with the Ventura FIO I/O modules Generates the LVDS system voltages
Controller	ASIC ET1100
Baud rate	100 Mbit/s
Cable.....	CAT5
Length of cable	max. 100m between 2 bus couplers
Ports.....	2x RJ45
Power supply	24 VDC -20% +25%
Connector Power	Plug 2-pole (part of the module)
Input current.....	50mA & E-bus power supply
E-bus power supply	max. 3A (approx. 20 modules)
E-bus load.....	195 mA
Part no.	694.400.00

4.2 D8/DO8

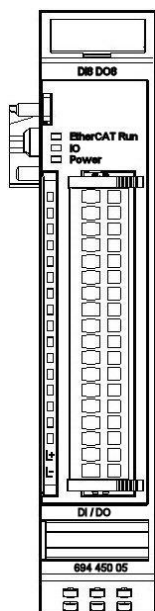

Figure 10: Front view of DI8/DO8 I/O module

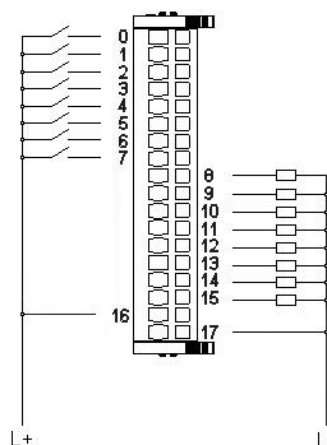

Figure 9: I/O connection

4.2.1 Terminals

Power supply to module I/Os

L+ 24 VDC
L- 0 V

4.2.2 Status LEDs

4.2.2.1 "EtherCAT Run" LED

The LED labeled "EtherCAT Run" indicates the state of the EtherCAT ASIC.

State	LED flash code	Explanation
Init	Off	Initialization, no data exchange
Pre-Op	Off/green, 1:1	Pre-operational, no data exchange
Safe-Op	Off/green, 5:1	Safe operation, inputs readable
Op	Green, on	Operational, unrestricted data exchange

4.2.2.2 "IO" LED

The LED labeled "IO" indicates the state of the module's I/Os.

State	LED flash code	Explanation
Ok	Off	No error
SC	Red, on	Short-circuited digital output



The output drivers have a thermal fuse to automatically turn off any short-circuited outputs. In case the short circuit prevails, the outputs are allowed to cool down to be turned back on until the thermal fuse blows again.

4.2.2.3 "Power" LED

The LED labeled "Power" indicates the state of the I/O module's I/O power supply.

State	LED flash code	Explanation
On	Green, on	24 VDC supply ok
Off	Off	24 VDC supply not ok



The module is not monitored for low voltage states.

4.2.2.4 "Channel" LEDs

State	LED	Explanation
On	Green, on	Input signal TRUE / output enabled
Off	Off	Input signal FALSE / output disabled

4.2.3 Function

The DI16/DO16 module features 16 digital inputs and 16 digital outputs.

4.2.3.1 Variable

Variable	Data type	Explanation
DigitalInputn	BOOL	Digital input (n=0...7)
DigitalOutputn	BOOL	Digital output (n=0...7)

4.2.4 Technical data

Digital inputs	8
Input delay	1 ms / 5 ms typically
Signal level.....	Off: -3V ... 5V (EN 61131-3, type 1) On: 15V ... 30V
Digital outputs	8
Max. current	0.5A per output
Total current.....	max. 8A
Connector IO/Power	Plug 18-pole (not part of the module)
Controller	ASIC ET1200
Baud rate	100 Mbit/s
Connector	10-pin system plug in side wall
Term. module.....	not required
Power supply	24 VDC -20% +25%
E-bus load.....	135mA
Part no.	694.450.04 5ms/0,5A 694.450.05 1ms/0,5A

4.3 DI16/DO16

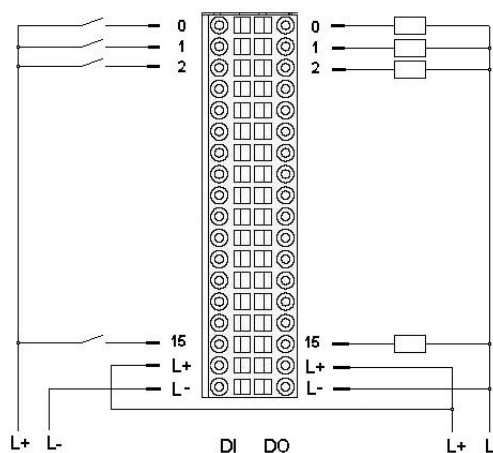
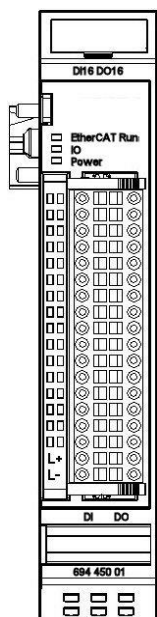

Figure 11: I/O connection

Figure 12: Front view of DI16/DO16 I/O module

4.3.1 Terminals

Power supply to module I/Os

- L+ 24 VDC
- L- 0 V



Connect L+ to both L+ terminals if the total current exceeds the 6A limit.

4.3.2 Status LEDs

4.3.2.1 "EtherCAT Run" LED

The LED labeled "EtherCAT Run" indicates the state of the EtherCAT ASIC.

State	LED flash code	Explanation
Init	Off	Initialization, no data exchange
Pre-Op	Off/green, 1:1	Pre-operational, no data exchange
Safe-Op	Off/green, 5:1	Safe operation, inputs readable
Op	Green, on	Operational, unrestricted data exchange

4.3.2.2 "IO" LED

The LED labeled "IO" indicates the state of the module's I/Os.

State	LED flash code	Explanation
Ok	Off	No error
SC	Red, on	Short-circuited digital output



The output drivers have a thermal fuse to automatically turn off any short-circuited outputs. In case the short circuit prevails, the outputs are allowed to cool down to be turned back on until the thermal fuse blows again.

4.3.2.3 "Power" LED

The LED labeled "Power" indicates the state of the I/O module's I/O power supply.

State	LED flash code	Explanation
On	Green, on	24 VDC supply ok
Off	Off	24 VDC supply not ok



The module is not monitored for low voltage states.

4.3.2.4 "Channel" LEDs

State	LED	Explanation
On	Green, on	Input signal TRUE / output enabled
Off	Off	Input signal FALSE / output disabled

4.3.3 Function

The DI16/DO16 module features 16 digital inputs and 16 digital outputs.

4.3.3.1 Variable

Variable	Data type	Explanation
DigitalInputn	BOOL	Digital input (n=0...15)
DigitalOutputn	BOOL	Digital output (n=0...15)

4.3.4 Technical data

Digital inputs	16
Input delay	1 ms / 5 ms typically
Input delay	Off: -3V ... 5V (EN 61131-3, type 1) On: 15V ... 30V
Digital outputs	16
Max. current	0.5A per output
Total current.....	max. 8A
Connector IO/Power	Plug 36-pole (not part of the module)
Controller	ASIC ET1200
Baud rate	100 Mbit/s
Connector	10-pin system plug in side wall
Term. module.....	not required
Power supply	24 VDC -20% +25%
E-bus load.....	135mA
Part no.	694.450.01 5ms/0,5A 694.450.03 1ms/0,5A

4.4 DI16/DO8

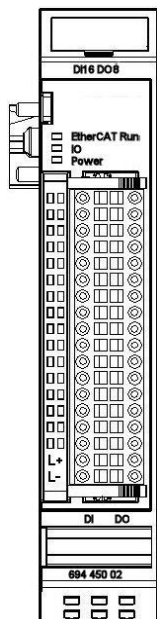

Figure 13: Front view of DI16/DO16 I/O module

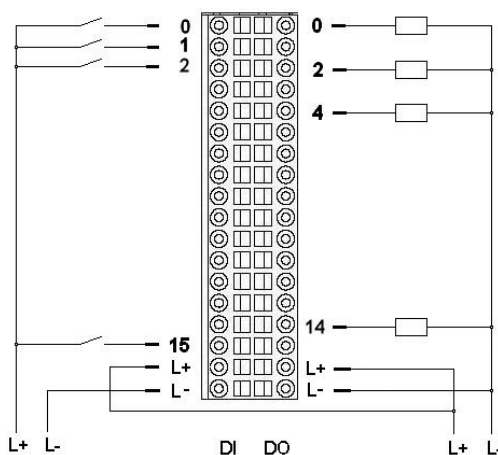

Figure 14: I/O connection

Out	Pin
0	0
1	2
2	4
3	6
4	8
5	10
6	12
7	14

4.4.1 Terminals

Power supply to module I/Os

L+ 24 VDC

L- 0 V



Connect L+ to both L+ terminals if the total current exceeds the 6A limit.

4.4.2 Status LEDs

4.4.2.1 "EtherCAT Run" LED

The LED labeled "EtherCAT Run" indicates the state of the EtherCAT ASIC.

State	LED flash code	Explanation
Init	Off	Initialization, no data exchange
Pre-Op	Off/green, 1:1	Pre-operational, no data exchange
Safe-Op	Off/green, 5:1	Safe operation, inputs readable
Op	Green, on	Operational, unrestricted data exchange

4.4.2.2 "IO" LED

The LED labeled "IO" indicates the state of the module's I/Os.

State	LED flash code	Explanation
Ok	Off	No error
SC	Red, on	Short-circuited digital output



The output drivers have a thermal fuse to automatically turn off any short-circuited outputs. In case the short circuit prevails, the outputs are allowed to cool down to be turned back on until the thermal fuse blows again.

4.4.2.3 "Power" LED

The LED labeled "Power" indicates the state of the I/O module's I/O power supply.

State	LED flash code	Explanation
On	Green, on	24 VDC supply ok
Off	Off	24 VDC supply not ok



The module is not monitored for low voltage states.

4.4.2.4 "Channel" LEDs

State	LED	Explanation
On	Green, on	Input signal TRUE / output enabled
Off	Off	Input signal FALSE / output disabled

4.4.3 Function

The DI16/DO8 module features 16 digital inputs and 8 digital outputs.

4.4.3.1 Variable

Variable	Data type	Explanation
DigitalInputn	BOOL	Digital input (n=0...15)
DigitalOutputn	BOOL	Digital output (n=0...7)
reserved	BOOL	Unused output addresses

4.4.4 Technical data

Digital inputs	16
Input delay	1 ms / 5 ms typically
Signal level.....	Off: -3V ... 5V (EN 61131-3, type 1) On: 15V ... 30V
Digital outputs	8
Max. current	1A per output
Total current.....	max. 8A
Connector IO/Power	Plug 36-pole (not part of the module)
Controller	ASIC ET1200
Baud rate	100 Mbit/s
Connector	10-pin system plug in side wall
Term. module.....	not required
Power supply	24 VDC -20% +25%
E-bus load.....	135mA
Part no.	694.450.02

4.5 DI16/DO16 LS (Low-side)

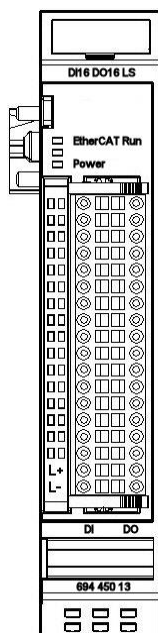

Figure 16: Front view of DI16/DO16 LS I/O module

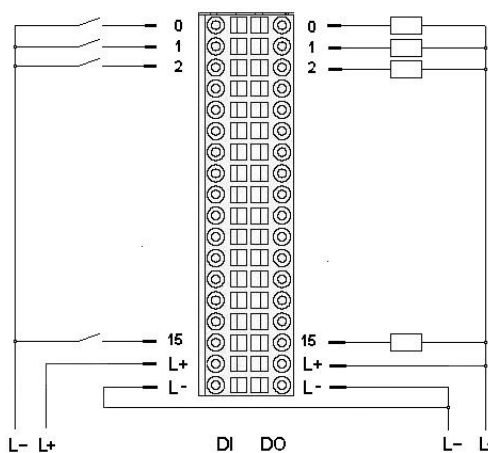

Figure 15: I/O connection

4.5.1 Terminals

Power supply to module I/Os

L+ 24 VDC

L- 0 V



Connect L- to both L- terminals if the total current exceeds the 6A limit.

4.5.2 Status LEDs

4.5.2.1 "EtherCAT Run" LED

The LED labeled "EtherCAT Run" indicates the state of the EtherCAT ASIC.

State	LED flash code	Explanation
Init	Off	Initialization, no data exchange
Pre-Op	Off/green, 1:1	Pre-operational, no data exchange
Safe-Op	Off/green, 5:1	Safe operation, inputs readable
Op	Green, on	Operational, unrestricted data exchange

4.5.2.2 "IO" LED

There is no LED labeled "IO".

4.5.2.3 "Power" LED

The LED labeled "Power" indicates the state of the I/O module's I/O power supply.

State	LED flash code	Explanation
On	Green, on	24 VDC supply ok
Off	Off	24 VDC supply not ok

4.5.2.4 "Channel" LEDs

State	LED	Explanation
On	Green, on	Input signal Low (TRUE) / output enabled
Off	Off	Input signal High (FALSE) / output disabled

4.5.3 Function

The DI16/DO16 LS module features 16 digital low-side inputs and 16 digital low-side outputs.



The output drivers have a thermal fuse to automatically turn off any short-circuited outputs. In case the short circuit prevails, the outputs are allowed to cool down to be turned back on until the thermal fuse blows again.



The module is not monitored for low voltage states.

4.5.3.1 Variable

Variable	Data type	Explanation
DigitalInputn	BOOL	Digital input (n=0...15)
DigitalOutputn	BOOL	Digital output (n=0...15)

4.5.4 Technical data

Digital inputs	16
Input delay	1ms (typically)
Signal level.....	On: -3V ... 5V Off: 15V ... 30V
Input current.....	2mA (typically)
Digital outputs	16
Max. current	0.5A per output
Total current.....	max. 8A
Connector IO/Power	Plug 36-pole (not part of the module)
Controller	ASIC ET1200
Baud rate	100 Mbit/s
Connector	10-pin system plug in side wall
Term. module.....	not required
Power supply	24 VDC -20% +25%
E-bus load.....	135mA
Part no.	694.450.13

4.6 DI32

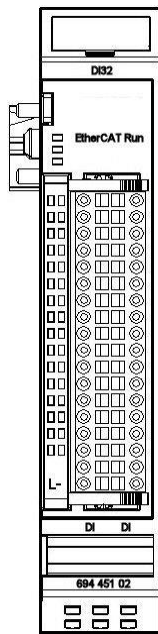

Figure 18: Front view of DI32 I/O module

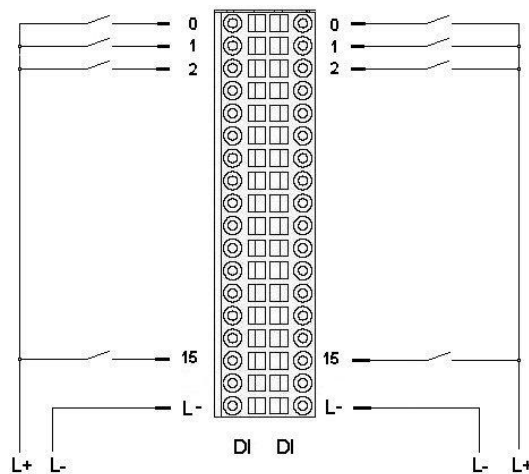

Figure 17: I/O connection

4.6.1 Terminals

Power supply to module I/Os

L- 0 V

4.6.2 Status LEDs

4.6.2.1 "EtherCAT Run" LED

The LED labeled "EtherCAT Run" indicates the state of the EtherCAT ASIC.

State	LED flash code	Explanation
Init	Off	Initialization, no data exchange
Pre-Op	Off/green, 1:1	Pre-operational, no data exchange
Safe-Op	Off/green, 5:1	Safe operation, inputs readable
Op	Green, on	Operational, unrestricted data exchange

4.6.2.2 "IO" LED

There is no LED labeled "IO".

4.6.2.3 "Power" LED

There is no LED labeled "Power" because a separate power feed is not required.

4.6.2.4 "Channel" LEDs

State	LED	Explanation
On	Green, on	Input signal = TRUE
Off	Off	Input signal = FALSE

4.6.3 Function

The DI32 module has 32 digital inputs.

4.6.3.1 Variable

Variable	Data type	Explanation
DigitalInputn	BOOL	Digital input (n=0...31)

4.6.4 Technical data

Digital inputs	32
Input delay	1 ms resp. 5 ms (typical)
Signal level.....	Off: -3V ... 5V (EN 61131-3, type 1) On: 15V ... 30V
Connector IO/Power	Plug 36-pole (not part of the module)
Controller	ASIC ET1100
Baud rate	100 Mbit/s
Connector	10-pin system plug in side wall
Term. module.....	not required
Power supply	24 VDC -20% +25%
E-bus load.....	85mA
Part no	
Ventura FIO DI16, 1ms	694.451.02
Ventura FIO DI16, 5ms	694.451.04

4.7 DI16

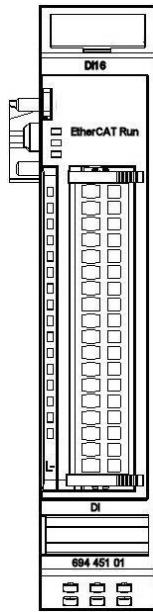

Figure 20: Front view of DI16 I/O module

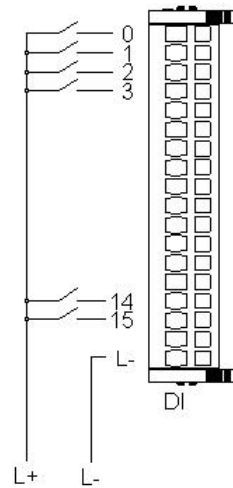

Figure 19: I/O connection

4.7.1 Terminals

Power supply to module I/Os

L- 0 V

4.7.2 Status LEDs

4.7.2.1 "EtherCAT Run" LED

The LED labeled "EtherCAT Run" indicates the state of the EtherCAT ASIC.

State	LED flash code	Explanation
Init	Off	Initialization, no data exchange
Pre-Op	Off/green, 1:1	Pre-operational, no data exchange
Safe-Op	Off/green, 5:1	Safe operation, inputs readable
Op	Green, on	Operational, unrestricted data exchange

4.7.2.2 "IO" LED

There is no LED labeled "IO".

4.7.2.3 "Power" LED

There is no LED labeled "Power" because a separate power feed is not required.

4.7.2.4 "Channel" LEDs

State	LED	Explanation
On	Green, on	Input signal = TRUE
Off	Off	Input signal = FALSE

4.7.3 Function

The DI16 module has 16 digital inputs.

4.7.3.1 Variable

Variable	Data type	Explanation
DigitalInputn	BOOL	Digital input (n=0...15)

4.7.4 Technical data

Digital inputs	16
Input delay	1 ms resp. 5 ms (typical)
Signal level.....	Off: -3V ... 5V (EN 61131-3, type 1) On: 15V ... 30V
Connector IO/Power	Plug 18-pole (not part of the module)
Controller	ASIC ET1200
Baud rate	100 Mbit/s
Connector	10-pin system plug in side wall
Term. module.....	not required
Power supply	24 VDC -20% +25%
E-bus load.....	100 mA
Part no	
Ventura FIO DI16, 5ms	694.451.01
Ventura FIO DI16, 1ms	694.451.03

4.8 DO16

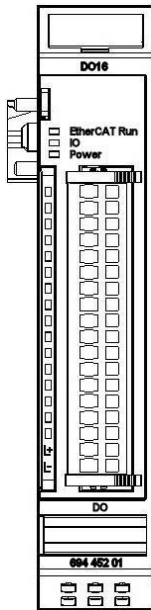

Figure 22: Front view of DO16 I/O module

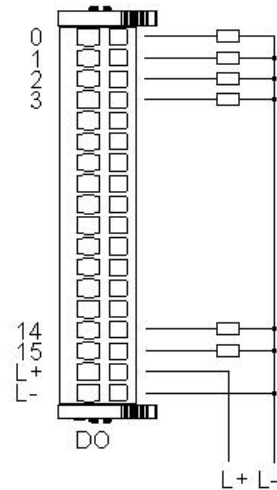

Figure 21: I/O connection

4.8.1 Terminals

Power supply to module I/Os

L+ 24 VDC

L- 0 V

4.8.2 Status LEDs

4.8.2.1 "EtherCAT Run" LED

The LED labeled "EtherCAT Run" indicates the state of the EtherCAT ASIC.

State	LED flash code	Explanation
Init	Off	Initialization, no data exchange
Pre-Op	Off/green, 1:1	Pre-operational, no data exchange
Safe-Op	Off/green, 5:1	Safe operation, inputs readable
Op	Green, on	Operational, unrestricted data exchange

4.8.2.2 "IO" LED

The LED labeled "IO" indicates the state of the module's I/Os.

State	LED flash code	Explanation
Ok	Off	No error
SC	Red, on	Short-circuited digital output



The output drivers have a thermal fuse to automatically turn off any short-circuited outputs. In case the short circuit prevails, the outputs are allowed to cool down to be turned back on until the thermal fuse blows again.

4.8.2.3 "Power" LED

The LED labeled "Power" indicates the state of the I/O module's I/O power supply.

State	LED flash code	Explanation
On	Green, on	24 VDC supply ok
Off	Off	24 VDC supply not ok



The module is not monitored for low voltage states.

4.8.2.4 "Channel" LEDs

State	LED	Explanation
On	Green, on	Output enabled
Off	Off	Output disabled

4.8.3 Function

The DO16 module has 16 digital outputs.

4.8.3.1 Variable

Variable	Data type	Explanation
DigitalOutputn	BOOL	Digital output (n=0...15)

4.8.4 Technical data

Digital outputs	16
Max current	0.5A per output
Total current	max. 8A
Connector IO/Power	Plug 18-pole (not part of the module)
Controller	ASIC ET1200
Baud rate	100 Mbit/s
Connector	10-pin system plug in side wall
Term. module	not required
Power supply	24 VDC -20% +25%
E-bus load	130mA
Part no.	694.452.01

4.9 DO8

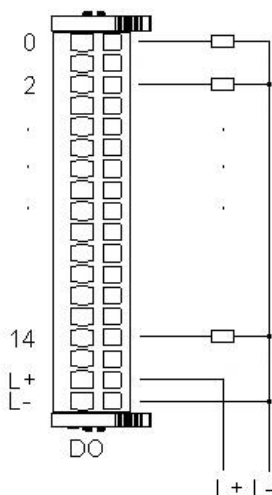
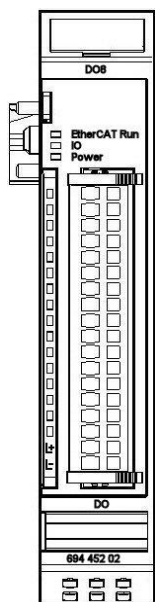

Out	Pin
0	0
1	2
2	4
3	6
4	8
5	10
6	12
7	14

Figure 23: I/O connection

Figure 24: Front view of DO8 I/O module

4.9.1 Terminals

Power supply to module I/Os

L+ 24 VDC

L- 0 V

4.9.2 Status LEDs

4.9.2.1 "EtherCAT Run" LED

The LED labeled "EtherCAT Run" indicates the state of the EtherCAT ASIC.

State	LED flash code	Explanation
Init	Off	Initialization, no data exchange
Pre-Op	Off/green, 1:1	Pre-operational, no data exchange
Safe-Op	Off/green, 5:1	Safe operation, inputs readable
Op	Green, on	Operational, unrestricted data exchange

4.9.2.2 "IO" LED

The LED labeled "IO" indicates the state of the module's I/Os.

State	LED flash code	Explanation
Ok	Off	No error
SC	Red, on	Short-circuited digital output



The output drivers have a thermal fuse to automatically turn off any short-circuited outputs. In case the short circuit prevails, the outputs are allowed to cool down to be turned back on until the thermal fuse blows again.

4.9.2.3 "Power" LED

The LED labeled "Power" indicates the state of the I/O module's I/O power supply.

State	LED flash code	Explanation
On	Green, on	24 VDC supply ok
Off	Off	24 VDC supply not ok



The module is not monitored for low voltage states.

4.9.2.4 "Channel" LEDs

State	LED	Explanation
On	Green, on	Output enabled
Off	Off	Output disabled

4.9.3 Function

The DO8 module has 8 digital outputs.

4.9.3.1 Variable

Variable	Data type	Explanation
DigitalOutputn	BOOL	Digital output (n=0...7)
reserved	BOOL	Unused output addresses

4.9.4 Technical data

Digital outputs	8
Max. current	1A per output
Total current	max. 8A
Connector IO/Power	Plug 18-pole (not part of the module)
Controller	ASIC ET1200
Baud rate	100 Mbit/s
Connector	10-pin system plug in side wall
Term. module	not required
Power supply	24 VDC -20% +25%
E-bus load	130mA
Part no.	694.452.02

4.10 AI4-I

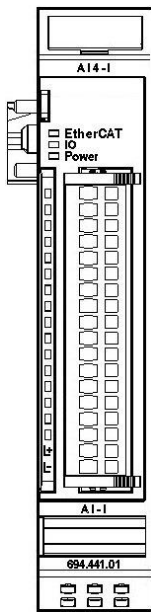

Figure 26: Front view of AI4-I I/O module

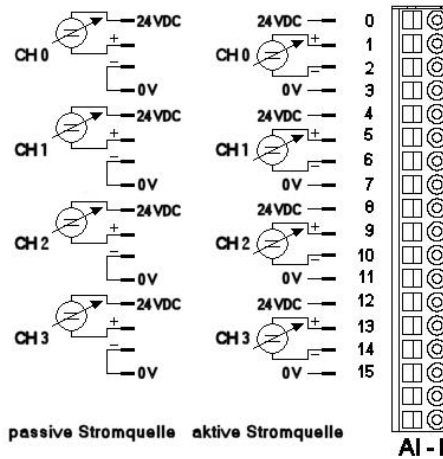

Figure 25: I/O connection passive/active power source

4.10.1 Terminals

Module supply: L+ 24 V DC
L- 0 V

Operative earth / shielding of analog wires → section 3.1.1

4.10.2 Status LEDs

4.10.2.1 "EtherCAT" LED

The LED labeled "EtherCAT" indicates the state of the EtherCAT ASIC.

State	LED flash code	Explanation
Init	Red, on	Initialization, no data exchange
Pre-Op	Red/green, 1:1	Pre-operational, no data exchange
Safe-Op	Red/green, 5:1	Safe operation, inputs readable
Op	Green, on	Operational, unrestricted data exchange

4.10.2.2 "IO" LED

The LED labeled "IO" indicates the state of the module's I/Os.

State	LED flash code	Explanation
Ok	Green, on	No error
Error	Off	Malfunction of module if E-bus LED = On Inoperative if E-bus LED = Off
	Red, 2x	Undervoltage (not implemented)
	Red, 3x	Watchdog
	Red, 4x	EtherCAT watchdog control
	Red, 6x	Module-specific fault
	Red, 7x	Configuration error (E-bus pre-operational), no. of process data differs from that in the module
Defective	Red, on	Module defective

4.10.2.3 "Power" LED

The LED labeled "Power" indicates the state of the I/O module's I/O power supply.

State	LED flash code	Explanation
On	Green, on	24 VDC supply ok
Off	Off	24 VDC supply not ok

4.10.2.4 "Channel" LEDs

State	LED flash code	Explanation
On	Green, on	Channel enabled
Off	Off	Channel disabled

4.10.3 Function

The AI4-I module has 4 analogue current signal inputs. Their measuring range can be set separately for every channel, i.e. either to 0..20mA or to 4..20mA.

4.10.3.1 Analogue inputs

Check the following variable for the digitized input values:

Variable	Data type	Explanation
Channel_n	INT	Value measured on channel n (n= 0...3)

4.10.3.2 Measured value

The maximal measuring value (0xFFF0) of the current input module is $0,5V/23,4 \Omega = 21,3675mA$.

The status is shown by the channel LED.

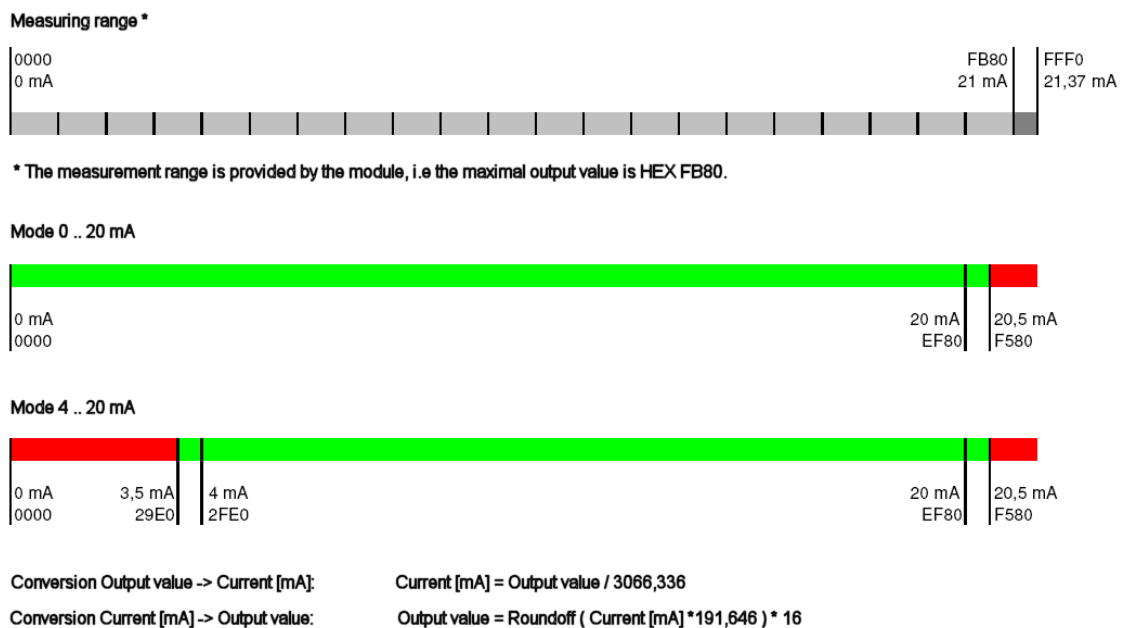

Figure 27: Measuring values, Variable values, Status

Measuring	Variable value		Measuring	Variable values	
	mA	decimal		hexadecimal	mA
0	0	0	11	33728	16#83C0
1	3056	16#0BF0	12	36784	16#8FB0
2	6128	16#17F0	13	39856	16#9BB0
3	9184	16#23E0	14	42928	16#A7B0
4	12256	16#2FE0	15	45984	16#B3A0
5	15328	16#3BE0	16	49056	16#BFA0
6	18384	16#47D0	17	52112	16#CB90
7	21456	16#53D0	18	55184	16#D790
8	24528	16#5FD0	19	58256	16#E390
9	27584	16#6BC0	20	61312	16#EF80
10	30656	16#77C0	20,5	62848	16#F580
			...		
			≥ 21,37	65520	16#FFF0

Figure 28: Analog values current

4.10.3.3 Module control

The module provides you with various operational options.

- To set up the module choose the options as appropriate and accept by setting control bit "SetOptions" to a rising edge. The module will confirm by returning "OptionsSet".

There are various "module error" bits that the module uses to indicate errors.

The states of the error bits are retained and also used for error indication by the "IO" LED.

- To reset the error bits set control bit "ResetError" to a rising edge.

Variable	Data type	Explanation
SetOptions	BOOL	Rising edge → accepts module options
ResetError	BOOL	Rising edge → acknowledges error

4.10.3.4 Module options

The following options are available for module AI4-I:

Variable	Data type		Explanation
Channel_n_0_20mA	BOOL	TRUE	Channel n to 0...20mA
		FALSE	Channel n to 4...20mA
Channel_n_On	BOOL		Enables channel n
Channel_n_Filter	USINT	0..255	Filter on channel n New values avail. in k/3 ms (k=1..255)
n		0 ... 3	Channel number

To set and accept options, see section 4.10.3.3.

4.10.3.5 Module state

The following states are indicated:

Variable	Data type	Explanation
Shortcut	BOOL	Short circuit
Undervoltage	BOOL	Low voltage (supplied power < 19.2V)
Watchdog	BOOL	Internal watchdog of module
EtherCAT_Error	BOOL	Configuration error or watchdog control
Specific_Error	BOOL	Module-specific fault
OptionsSet	BOOL	Sent by module to acknowledge SetOptions

To reset the messages, see section 4.10.3.3.

4.10.3.6 Module-specific messages

Apart from the module error messages, there is a set of messages containing details about the current state of the module:

Variable	Data type	Explanation
Channel_n_Overcurrent	BOOL	Input current > 20 mA → Specific_Error = TRUE
Channel_n_Open	BOOL	4..20mA mode: input current < 4mA → Specific_Error = TRUE

These messages are automatically reset when the state concerned has returned to normal.

4.10.3.7 Conversion time

The analogue signals are converted one by one down every channel. Disabling one or several channels will shorten the entire A/D conversion cycle. 'Filter' in this case means to compute an average when the set filter time is over.

Analogue value conversion runs cyclically and is not synchronized with the receipt of EtherCAT telegrams. The cycle consists of the analogue value conversion plus transmitting the values into the EtherCAT data area.

Number of channels	Cycle time in ms
1	0,27
2	0,41
3	0,55
4	0,69



If you are aiming for a high sampling frequency, the EtherCAT master should do the filtering (averaging) because it will normally have much more processing power.



Take the EtherCAT cycle into account to assess how much the values stored by the EtherCAT master are up-to-date. The module described in this section will accept the above times as the ideal EtherCAT cycle setup.

4.10.3.8 Quality of analogue values

The inputs connect to both active or passive current sensors, (see Figure 25: I/O connection).

The module provides terminals for the 24VDC- supply to the transmitter of every channel.

Passive current sensors:

- Interconnect the "-" and "0V" terminals.

Active current sensors:

- Use the power supplied by the module if at all possible.
- If power to the current sensors is supplied by an external source, connect the 0V terminal of that power source to the 0V terminal of the module.

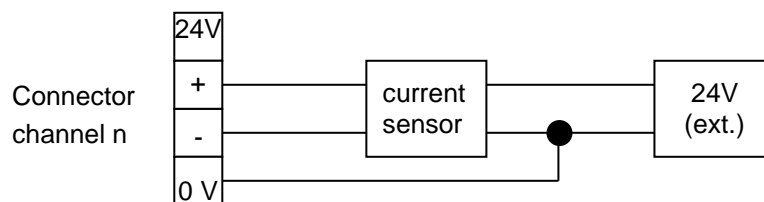

Best results are obtained by connected the shield of the signal cables to operative earth.

4.10.4 Technical data

Analogue inputs	4 single-ended
Resolution	12 bit
Measuring range	0 ... 20mA, 4..20mA (limit 21.3675mA)
Temperature drift	< ± 25 ppm/°C regarding range limit
Critical frequency	typical 12,5 Hz
Burden	< 75 Ω
Sampling frequency	1,45 kHz (if all channels are enabled)
Connector IO/Power	Plug 18-pole (not part of the module)
Controller	ASIC ET1200
Baud rate	100 Mbit/s
E-bus port	10-pin system plug in side wall
Term. module	not required
Power supply	from coupler through E-bus connector
E-bus load	140mA
Part no.	694.441.01

4.11 AI8-I

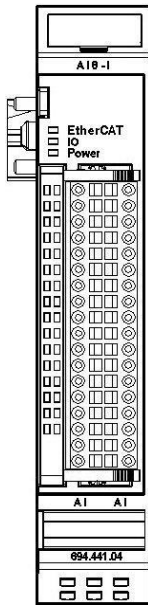

Figure 30: Front view of AI4-I I/O module

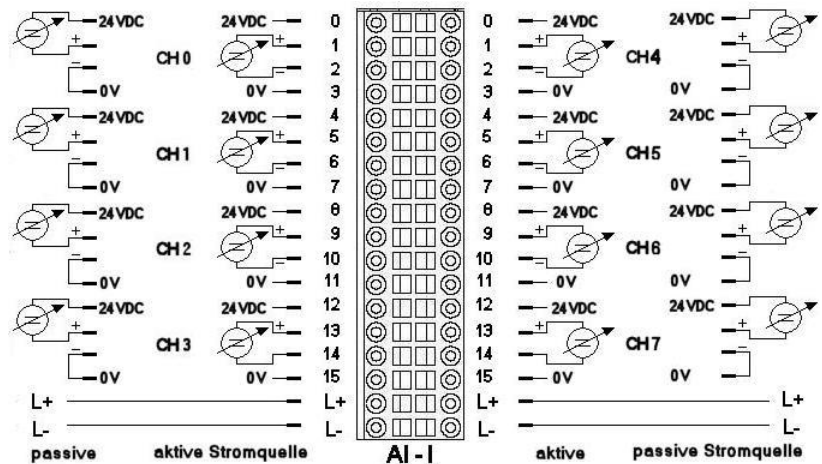

Figure 29: I/O connection passive/active power source

4.11.1 Terminals

Module supply: L+ 24 V DC
L- 0 V

Operative earth / shielding of analog wires → section 3.1.1

4.11.2 Status LEDs

4.11.2.1 "EtherCAT" LED

4.11.2.2 The LED labeled "EtherCAT" indicates the state of the EtherCAT ASIC.

State	LED flash code	Explanation
Init	Red, on	Initialization, no data exchange
Pre-Op	Red/green, 1:1	Pre-operational, no data exchange
Safe-Op	Red/green, 5:1	Safe operation, inputs readable
Op	Green, on	Operational, unrestricted data exchange

4.11.2.3 "IO" LED

The LED labeled "IO" indicates the state of the module's I/Os.

State	LED flash code	Explanation
Ok	Green, on	No error
Error	Off	Malfunction of module if E-bus LED = On Inoperative if E-bus LED = Off
	Red, 2x	Undervoltage (not implemented)
	Red, 3x	Watchdog
	Red, 4x	EtherCAT watchdog control
	Red, 6x	Module-specific fault
	Red, 7x	Configuration error (E-bus pre-operational), no. of process data differs from that in the module
Defective	Red, on	Module defective

4.11.2.4 "Power" LED

The LED labeled "Power" indicates the state of the I/O module's I/O power supply.

State	LED flash code	Explanation
On	Green, on	24 VDC supply ok
Off	Off	24 VDC supply not ok

4.11.2.5 "Channel" LEDs

State	LED flash code	Explanation
On	Green, on	Channel enabled
Off	Off	Channel disabled

4.11.3 Function

The AI8-I module has 8 analogue current signal inputs. Their measuring range can be set separately for every channel, i.e. either to 0..20mA or to 4..20mA.

4.11.3.1 Analogue inputs

Check the following variable for the digitized input values:

Variable	Data type	Explanation
Channel_n	INT	Value measured on channel n (n= 0...7)

4.11.3.2 Measured value

The maximal measuring value (0xFFF0) of the current input module is $0,5V/23,4 \Omega = 21,3675mA$.

The status is shown by the channel LED.

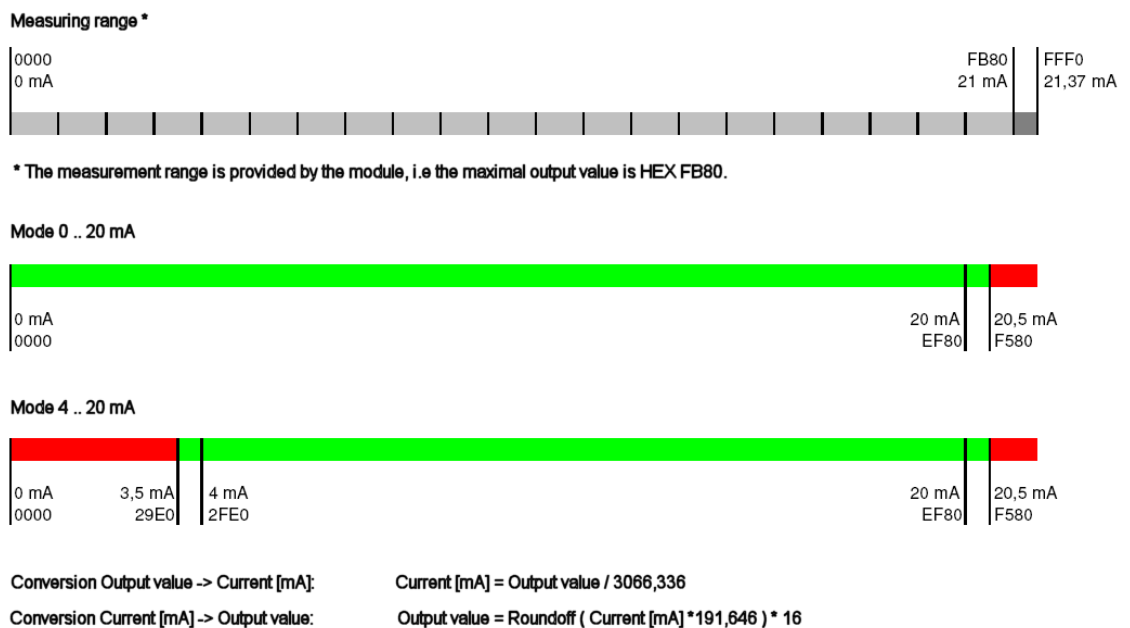

Figure 31: Measuring values, Variable values, Status

Measuring	Variable value		Measuring	Variable values	
	decimal	hexadecimal		decimal	hexadecimal
0	0	0	11	33728	16#83C0
1	3056	16#0BF0	12	36784	16#8FB0
2	6128	16#17F0	13	39856	16#9BB0
3	9184	16#23E0	14	42928	16#A7B0
4	12256	16#2FE0	15	45984	16#B3A0
5	15328	16#3BE0	16	49056	16#BFA0
6	18384	16#47D0	17	52112	16#CB90
7	21456	16#53D0	18	55184	16#D790
8	24528	16#5FD0	19	58256	16#E390
9	27584	16#6BC0	20	61312	16#EF80
10	30656	16#77C0	20,5	62848	16#F580
			...		
			≥ 21,37	65520	16#FFF0

Figure 32: Analog values current

4.11.3.3 Module control

The module provides you with various operational options.

- To set up the module choose the options as appropriate and accept by setting control bit "SetOptions" to a rising edge. The module will confirm by returning "OptionsSet".

There are various "module error" bits that the module uses to indicate errors.

The states of the error bits are retained and also used for error indication by the "IO" LED.

- To reset the error bits set control bit "ResetError" to a rising edge.

Variable	Data type	Explanation
SetOptions	BOOL	Rising edge → accepts module options
ResetError	BOOL	Rising edge → acknowledges error

4.11.3.4 Module options

The following options are available for module AI4-I:

Variable	Data type		Explanation
Channel_n_0_20mA	BOOL	TRUE	Channel n to 0...20mA
		FALSE	Channel n to 4...20mA
Channel_n_On	BOOL		Enables channel n
Channel_n_Filter	USINT	0..255	Filter on channel n New values avail. in k/3 ms (k=1..255)
n		0 ... 7	Channel number

To set and accept options, see section 4.11.3.3.

Figure 66:
Measurements of the clamp14mm

4.11.3.5 Module state

The following states are indicated:

Variable	Data type	Explanation
Shortcut	BOOL	Short circuit
Undervoltage	BOOL	Low voltage (supplied power < 19.2V)
Watchdog	BOOL	Internal watchdog of module
EtherCAT_Error	BOOL	Configuration error or watchdog control
Specific_Error	BOOL	Module-specific fault
OptionsSet	BOOL	Sent by module to acknowledge SetOptions

To reset the messages, see section 4.11.3.3.

4.11.3.6 Module-specific messages

Apart from the module error messages, there is a set of messages containing details about the current state of the module:

Variable	Data type	Explanation
Channel_n_Overcurrent	BOOL	Input current > 20 mA → Specific_Error = TRUE
Channel_n_Open	BOOL	4..20mA mode: input current < 4mA → Specific_Error = TRUE

These messages are automatically reset when the state concerned has returned to normal.

4.11.3.7 Conversion time

The analogue signals are converted one by one down every channel. Disabling one or several channels will shorten the entire A/D conversion cycle. 'Filter' in this case means to compute an average when the set filter time is over.

Analogue value conversion is not synchronized with the receipt of EtherCAT telegrams. Analogue value conversion runs cyclically and is not synchronized with the receipt of EtherCAT telegrams. The cycle consists of the analogue value conversion plus transmitting the values into the EtherCAT data area.

Number of channels	Cycle time in ms	Number of channels	Cycle time in ms
1	0,40	5	0,92
2	0,53	6	1,06
3	0,66	7	1,19
4	0,79	8	1,32



If you are aiming for a high sampling frequency, the EtherCAT master should do the filtering (averaging) because it will normally have much more processing power.



Take the EtherCAT cycle into account to assess how much the values stored by the EtherCAT master are up-to-date. The module described in this section will accept the above times as the ideal EtherCAT cycle setup.

4.11.3.8 Quality of analogue values

The inputs connect to both active or passive current sensors, (see Figure 25: I/O connection).

The module provides terminals for the 24VDC- supply to the transmitter of every channel.

Passive current sensors:

- Interconnect the "-" and "0V" terminals.

Active current sensors:

- Use the power supplied by the module if at all possible.
- If power to the current sensors is supplied by an external source, connect the 0V terminal of that power source to the 0V terminal of the module.

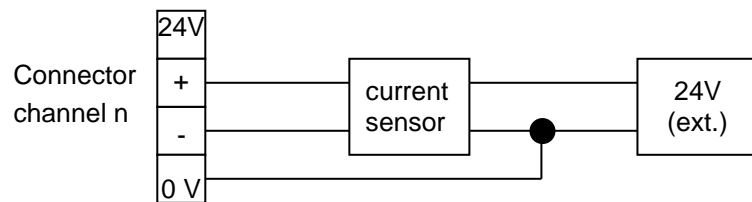

Best results are obtained by connected the shield of the signal cables to operative earth.

4.11.4 Technical data

Analogue inputs	8 single-ended
Resolution	12 bit
Measuring range	0 ... 20mA, 4..20mA (limit 21.3675mA)
Temperature drift	< ± 25 ppm/°C regarding range limit
Critical frequency	typical 12,5 Hz
Burden	< 75 Ω
Sampling frequency	0,76 kHz (if all channels are enabled)
Connector IO/Power	Plug 18-pole (not part of the module)
Controller	ASIC ET1200
Baud rate	100 Mbit/s
E-bus port	10-pin system plug in side wall
Term. module	not required
Power supply	from coupler through E-bus connector
E-bus load	160mA
Part no.	694.441.04

4.12 AI4/8-U

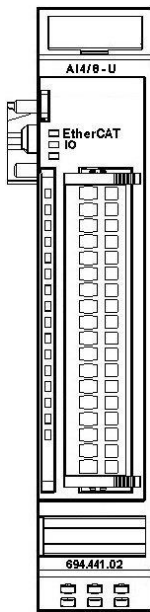

Figure 34: Front view of AI4/8-U I/O module

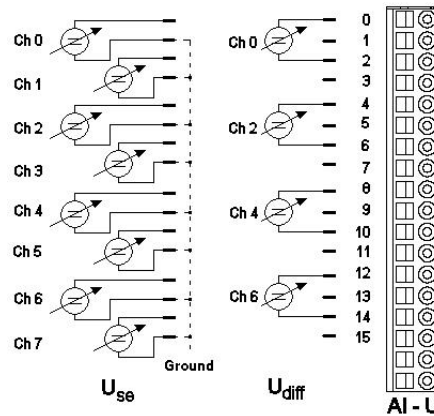

Figure 33: I/O connection

4.12.1 Terminals

The module needs no separate 24V connector. Power is supplied to the module through the E-bus connector.

Operative earth / shielding of analog wires → section 3.1.1

4.12.2 Status LEDs

4.12.2.1 "EtherCAT" LED

4.12.2.2 The LED labeled "EtherCAT" indicates the state of the EtherCAT ASIC.

State	LED flash code	Explanation
Init	Red, on	Initialization, no data exchange
Pre-Op	Red/green, 1:1	Pre-operational, no data exchange
Safe-Op	Red/green, 5:1	Safe operation, inputs readable
Op	Green, on	Operational, unrestricted data exchange

4.12.2.3 "IO" LED

The LED labeled "IO" indicates the state of the module's I/Os.

State	LED flash code	Explanation
Ok	Green, on	No error
Error	Off	Malfunction of module if E-bus LED = On Inoperative if E-bus LED = Off
	Red, 3x	Watchdog
	Red, 4x	EtherCAT watchdog control
	Red, 6x	Module-specific fault
	Red, 7x	Configuration error (E-bus pre-operational), no. of process data differs from that in the module
Defective	Red, on	Module defective

4.12.2.4 "Power" LED

There is no LED labeled "Power" because a separate power feed is not required.

4.12.2.5 "Channel" LEDs

State	LED flash code	Explanation
On	Green, on	Channel enabled
Off	Off	Channel disabled

4.12.3 Function

The AI4/8-U module has 8 analogue inputs. If signal lines are single-ended (measured against earth, L-), 8 channels are available. To measure differential signals, you will need 2 channels for every signal, i.e. you can pick up no more than 4 differential signals. Channels can be combined as follows: 0/1, 2/3, 4/5 and 6/7.

4.12.3.1 Analogue inputs

Check the following variable for the digitized input values:

Variable	Data type	Explanation
Channel_n	INT	Value measured on channel n (n= 0...7)

4.12.3.2 Measuring value

Measuring	Variable value			
	bipolar		unipolar	
Volt	decimal	hexadecimal	decimal	hexadecimal
-10	32768	16#8000		
-9	36044	16#8CCC		
-8	39321	16#9999		
-7	42598	16#A666		
-6	45875	16#B333		
-5	49152	16#C000		
-4	52428	16#CCCC		
-3	55705	16#D999		
-2	58982	16#E666		
-1	62244	16#F324		
0	0	0	0	0
1	3276	16#0CCC	6553	16#1999
2	6553	16#1999	13107	16#3332
3	9830	16#2666	19660	16#4CCC
4	13106	16#3332	26214	16#6665
5	16383	16#3FFF	32767	16#7FFF
6	19660	16#4CCC	39320	16#9998
7	22936	16#5998	45874	16#B332
8	26213	16#6665	52427	16#CCCB
9	29490	16#7332	58981	16#E665
10	32767	16#7FFF	65534	16#FFFE

Figure 35: Analog values Voltage

4.12.3.3 Module control

The module provides you with various operational options.

- To set up the module choose the options as appropriate and accept by setting control bit "SetOptions" to a rising edge. The module will confirm by returning "OptionsSet".

There are various "module error" bits that the module uses to indicate errors. The states of the error bits are retained and also used for error indication by the "IO" LED.

- To reset the error bits set control bit "ResetError" to a rising edge.

Variable	Data type	Explanation
SetOptions	BOOL	Rising edge → accepts module options
ResetError	BOOL	Rising edge → acknowledges error

4.12.3.4 Module options

The following options are available for module AI4/8-U:

Variable	Data type	Explanation
Channel_n_On	BOOL	Enables channel n
Channel_n_Filter	USINT	Filter on channel n New values avail. in k/3 ms (k=1..255)
Channel_n_Unipolar	BOOL	Change measuring range of channel n from bipolar +10V ... -10V to unipolar 0... 10V (doubles the resolution)
Channel_n_n+1_Differential	BOOL	The difference in voltages of channel n and channel n+1 is measured and output to channel n.
n		0 ... 7 Channel number

To set and accept options, see section 4.12.3.4.

4.12.3.5 Module state

The following states are indicated:

Variable	Data type	Explanation
Shortcut	BOOL	not used
Undervoltage	BOOL	not used
Watchdog	BOOL	module internal watchdog
EtherCAT_Error	BOOL	Configuration error or watchdog control
Specific_Error	BOOL	Module-specific fault
OptionsSet	BOOL	Sent by module to acknowledge SetOptions

To reset the messages, see section 4.12.3.4.

4.12.3.6 Module-specific messages

There are no module-specific messages for this module.

4.12.3.7 Conversion time

The analogue signals are converted one by one down every channel. Disabling one or several channels will shorten the entire A/D conversion cycle. 'Filter' in this case means to compute an average when the set filter time is over.

Analogue value conversion runs cyclically and is not synchronized with the receipt of EtherCAT telegrams. The cycle consists of the analogue value conversion plus transmitting the values into the EtherCAT data area.

Number of channels	Cycle time in ms	Number of channels	Cycle time in ms
1	270µs	5	630µs
2	360µs	6	710µs
3	450µs	7	800µs
4	540µs	8	890µs



If you are aiming for a high sampling frequency, the EtherCAT master should do the filtering (averaging) because it will normally have much more processing power.



Take the EtherCAT cycle into account to assess how much the values stored by the EtherCAT master are up-to-date. The module described in this section will accept the above times as the ideal EtherCAT cycle setup.

4.12.3.8 Quality of analogue values



Best results are obtained by

- connecting the shield of the signal cables to operative earth
- connecting unused single-ended lines to Ground
- short-circuiting unused differential inputs

4.12.4 Technical data

Analogue inputs	8 single-ended or 4 differential
Resolution	13 bit (1,221 mV unipolar, 2,442 mV bipolar)
Measuring range	0 ... 10V, \pm 10V
Temperature drift	< -15 ppm/°C regarding range limit
Critical frequency	typical 1 MHz
Input resistance.....	> 100 M Ω
Sampling frequency	1,12 kHz (if all channels are enabled)
Connector IO/Power	Plug 18-pole (not part of the module)
Controller	ASIC ET1200
Baud rate	100 Mbit/s
E-bus port	10-pin system plug in side wall
Term. module.....	not required
Power supply	from coupler through E-bus connector
E-bus load.....	190mA
Part no.	694.441.02

4.13 AI8/16-U

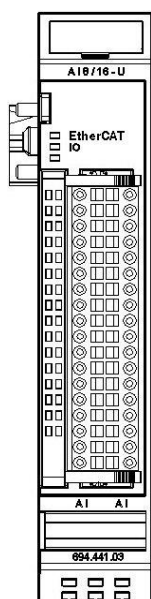

Figure 37: Front view of AI8/16-U I/O module

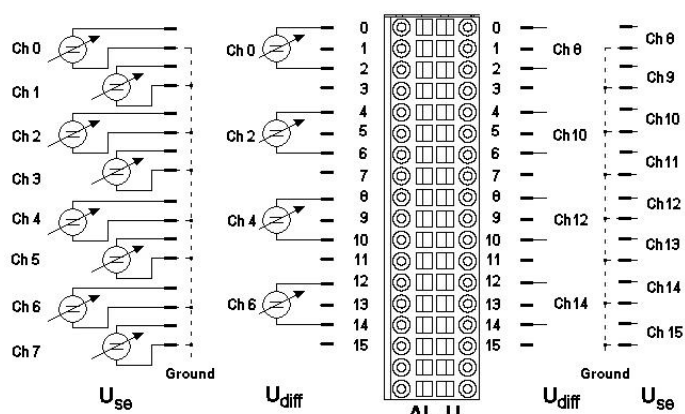

Figure 36: I/O connection

4.13.1 Terminals

The module needs no separate 24V connector. Power is supplied to the module through the E-bus connector.

Operative earth / shielding of analog wires → section 3.1.1

4.13.2 Status LEDs

4.13.2.1 "EtherCAT" LED

4.13.2.2 The LED labeled "EtherCAT" indicates the state of the EtherCAT ASIC.

State	LED flash code	Explanation
Init	Red, on	Initialization, no data exchange
Pre-Op	Red/green, 1:1	Pre-operational, no data exchange
Safe-Op	Red/green, 5:1	Safe operation, inputs readable
Op	Green, on	Operational, unrestricted data exchange

4.13.2.3 "IO" LED

The LED labeled "IO" indicates the state of the module's I/Os.

State	LED flash code	Explanation
Ok	Green, on	No error
Error	Off	Malfunction of module if E-bus LED = On Inoperative if E-bus LED = Off
	Red, 3x	Watchdog
	Red, 4x	EtherCAT watchdog control
	Red, 6x	Module-specific fault
	Red, 7x	Configuration error (E-bus pre-operational), no. of process data differs from that in the module
Defective	Red, on	Module defective

4.13.2.4 "Power" LED

There is no LED labeled "Power" because a separate power feed is not required.

4.13.2.5 "Channel" LEDs

State	LED flash code	Explanation
On	Green, on	Channel enabled
Off	Off	Channel disabled

4.13.3 Function

The AI8/16-U module has 16 analogue inputs. If signal lines are single-ended (measured against earth), 16 channels are available. To measure differential signals, you will need 2 channels for every signal, i.e. you can pick up no more than 8 differential signals. Channels can be combined as follows: 0/1, 2/3, 4/5, 6/7, 8/9, 10/11, 12/13 and 14/15.

4.13.3.1 Analogue inputs

Check the following variable for the digitized input values:

Variable	Data type	Explanation
Channel_n	INT	Value measured on channel n (n= 0...7)

4.13.3.2 Measuring value

Measuring	Variable value			
	bipolar		unipolar	
Volt	decimal	hexadecimal	decimal	hexadecimal
-10	65535	16#FFFF		
-9	62258	16#F32C		
-8	58982	16#E660		
-7	55705	16#D994		
-6	52428	16#CCC8		
-5	49152	16#BFFC		
-4	45875	16#B330		
-3	42598	16#A664		
-2	39321	16#9998		
-1	36045	16#8CCC		
0	0	0	0	0
1	3276	16#0CCC	6553	16#1999
2	6553	16#1999	13107	16#3332
3	9830	16#2666	19660	16#4CCC
4	13106	16#3332	26214	16#6665
5	16383	16#3FFF	32767	16#7FFF
6	19660	16#4CCC	39320	16#9998
7	22936	16#5998	45874	16#B332
8	26213	16#6665	52427	16#CCCB
9	29490	16#7332	58981	16#E665
10	32767	16#7FFF	65534	16#FFFE

Figure 38: Analog values Voltage

4.13.3.3 Module control

The module provides you with various operational options.

- To set up the module choose the options as appropriate and accept by setting control bit "SetOptions" to a rising edge. The module will confirm by returning "OptionsSet".

There are various "module error" bits that the module uses to indicate errors. The states of the error bits are retained and also used for error indication by the "IO" LED.

- To reset the error bits set control bit "ResetError" to a rising edge.

Variable	Data type	Explanation
SetOptions	BOOL	Rising edge → accepts module options
ResetError	BOOL	Rising edge → acknowledges error

4.13.3.4 Module options

The following options are available for module AI4/8-U:

Variable	Data type	Explanation
Channel_n_On	BOOL	Enables channel n
Channel_n_Filter	USINT	Filter on channel n New values avail. in k/3 ms (k=1..255)
Channel_n_Unipolar	BOOL	Change measuring range of channel n from bipolar +10V ... -10V to unipolar 0... 10V (doubles the resolution)
Channel_n_n+1_Differential	BOOL	The difference in voltages of channel n and channel n+1 is measured and output to channel n.
n		0 ... 15 Channel number

To set and accept options, see section 4.13.3.3.

4.13.3.5 Module state

The following states are indicated:

Variable	Data type	Explanation
Shortcut	BOOL	not used
Undervoltage	BOOL	not used
Watchdog	BOOL	module internal watchdog
EtherCAT_Error	BOOL	Configuration error or watchdog control
Specific_Error	BOOL	Module-specific fault
OptionsSet	BOOL	Sent by module to acknowledge SetOptions

To reset the messages, see section 4.13.3.3.

4.13.3.6 Module-specific messages

There are no module-specific messages for this module.

4.13.3.7 Conversion time

The analogue signals are converted one by one down every channel. Disabling one or several channels will shorten the entire A/D conversion cycle. 'Filter' in this case means to compute an average when the set filter time is over.

Analogue value conversion runs cyclically and is not synchronized with the receipt of EtherCAT telegrams. The cycle consists of the analogue value conversion plus transmitting the values into the EtherCAT data area.

Number of channels	Cycle time in ms	Number of channels	Cycle time in ms
1	530µs	9	1,27ms
2	620µs	10	1,36ms
3	710µs	11	1,45ms
4	810µs	12	1,54ms
5	900µs	13	1,63ms
6	990µs	14	1,73ms
7	1,08ms	15	1,82ms
8	1,17ms	16	1,91ms



Take the EtherCAT cycle into account to assess how much the values stored by the EtherCAT master are up-to-date. The module described in this section will accept the above times as the ideal EtherCAT cycle setup.



If you are aiming for a high sampling frequency, the EtherCAT master should do the filtering (averaging) because it will normally have much more processing power.

4.13.3.8 Quality of analogue values



Best results are obtained by

- connecting the shield of the signal cables to operative earth
- connecting unused single-ended lines to Ground
- short-circuiting unused differential inputs

4.13.4 Technical data

Analogue inputs	16 single-ended or 4 differential
Resolution	13 bit (1,221 mV unipolar, 2,442 mV bipolar)
Measuring range	0 ... 10V, $\pm 10V$
Sampling frequency	> 0,52 kHz (if all channels are enabled)
Temperature drift	< -15 ppm/°C regarding range limit
Critical frequency	typical 1 MHz
Input resistance.....	> 100 M Ω
Connector IO/Power	Plug 36-pole (not part of the module)
Controller	ASIC ET1200
Baud rate	100 Mbit/s
E-bus port	10-pin system plug in side wall
Term. module.....	not required
Power supply	from coupler through E-bus connector
E-bus load.....	220mA
Part no.	694.441.03

4.14 AO4-U/I

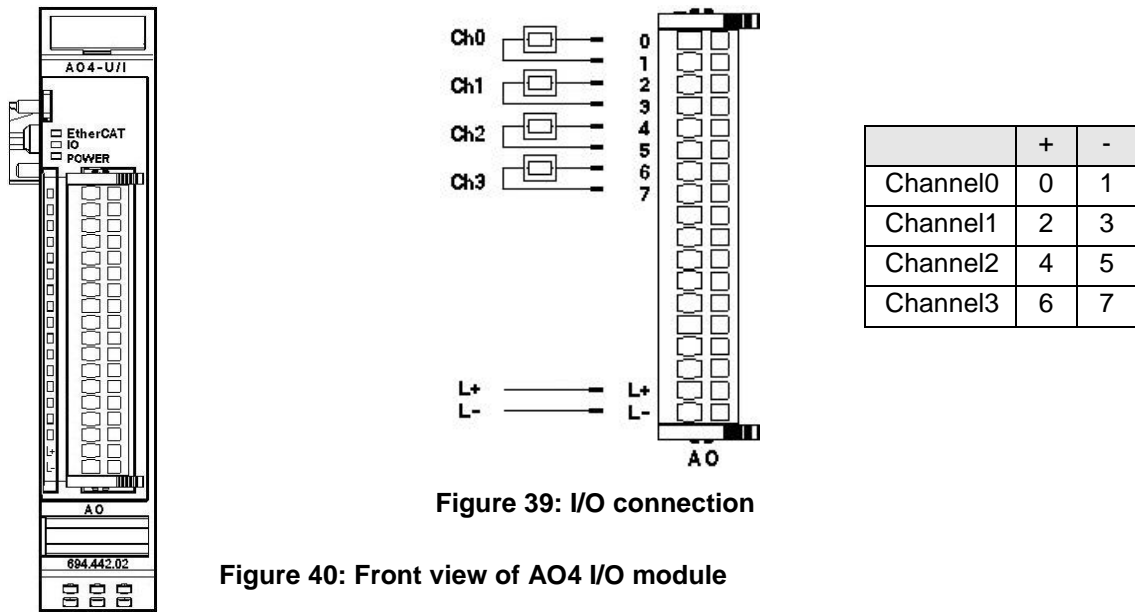

4.14.1 Terminals

Power supply to module I/Os

L+ 24 VDC

L- 0 V

4.14.2 Status LEDs

4.14.2.1 "EtherCAT" LED

The LED labeled "EtherCAT" indicates the state of the EtherCAT ASIC.

State	LED flash code	Explanation
Init	Red, on	Initialization, no data exchange
Pre-Op	Red/green, 1:1	Pre-operational, no data exchange
Safe-Op	Red/green, 5:1	Safe operation, inputs readable
Op	Green, on	Operational, unrestricted data exchange

4.14.2.2 "IO" LED

The LED labeled "IO" indicates the state of the module's I/Os.

State	LED flash code	Explanation
Ok	Green, on	No error
Error	Off	Malfunction of module if E-bus LED = On Inoperative if E-bus LED = Off
	Red, 1x	Short circuit
	Red, 2x	Low voltage
	Red, 4x	EtherCAT watchdog control
	Red, 6x	Module-specific fault
	Red, 7x	Configuration error (E-bus pre-operational), no. of process data differs from that in the module
Defective	Red, on	Module defective

4.14.2.3 "Power" LED

The LED labeled "Power" indicates the state of the I/O module's I/O power supply.

State	LED flash code	Explanation
On	Green, on	24 VDC supply ok
Off	Off	24 VDC supply not ok

4.14.2.4 "Channel" LEDs

State	LED flash code	Explanation
On	Green, on	Channel enabled
Off	Off	Channel disabled
Error	Red, 1x	Short circuit
	Red, 3x	Broken wire
	Red, 5x	Excessive temp. of output drivers

4.14.3 Function

The AO4 module has 4 analogue outputs. Every channel can be separately set to the unipolar or bipolar output of voltages or currents.

The letter 'n' in the tables below represents the channel number (n=0...3).

4.14.3.1 Analogue outputs

- Write the output values into the following variables:

Variable	Data type	Explanation
Channel_n	UINT	Output value for channel n (n=0...3).

Voltage: see Figure 35: Analog values Voltage at page 51

Current: 0 ... 0xFFFF0 for 0 ... 20mA

4.14.3.2 Module control

The module provides you with various operational options.

- To set up the module choose the options as appropriate and accept by setting control bit "SetOptions" to a rising edge. The module will confirm by returning "OptionsSet".

There are various "module error" bits that the module uses to indicate errors. The states of the error bits are retained and also used for error indication by the "IO" LED.

- To reset the error bits set control bit "ResetError" to a rising edge.

Variable	Data type	Explanation
SetOptions	BOOL	Rising edge → accepts module options
ResetError	BOOL	Rising edge → acknowledges error

4.14.3.3 Module options

The following options are available for module AO4:

Variable	Data type	Explanation
Channel_n_On	BOOL	Enables channel n (set to high impedance to disable)
Channel_n_Current	BOOL	Sets channel n to current output mode
Channel_n_n+1_Unipolar	BOOL	Sets channels 1 and 2 or 2 and 3 to unipolar mode
Outputs_Active_Shortcut	BOOL	Leave outputs unchanged after short circuit
Outputs_Active_Undervoltage	BOOL	Leave outputs unchanged after low voltage
Outputs_Active_Specific_Error	BOOL	Leave outputs unchanged after module-specific error (see 4.14.3.5)
Outputs_Active_EtherCAT_Error	BOOL	Leave outputs unchanged after short circuit
n		0 ... 3 Channel number

To set and accept options, see section 4.14.3.2.

4.14.3.4 Module state

The following module states are indicated:

Variable	Data type	Explanation
Shortcut	BOOL	Short circuit (not used)
Undervoltage	BOOL	Low voltage (supplied power < 19.2V)
Watchdog	BOOL	module internal watchdog
EtherCAT_Error	BOOL	Configuration error or watchdog control
Specific_Error	BOOL	Module-specific fault
OptionsSet	BOOL	Sent by module to acknowledge SetOptions

To reset the messages, see section 4.14.3.2.

4.14.3.5 Module-specific messages

Apart from the module error messages, there is a set of messages containing details about the current state of the module:

Variable	Data type	Explanation
Channel_n_Overtemp	BOOL	Temperature of output driver of channel n is gt 140°C (automatic switch-off), i.e. shortcut See Module options, Outputs_Active_Shortcut
Undervoltage_24	BOOL	Power supplied to module is gt 19.2V See Module options, Outputs_Active_Undervoltage
Channel_n_Open	BOOL	Current mode: channel n load is gt 500Ω ➔ Specific_Error = TRUE
Channel_n_Shortcut	BOOL	Voltage mode: channel n load is lt 600Ω ➔ Specific_Error = TRUE

These messages are automatically reset when the state concerned has returned to normal.

Channel_n_Open and Channel_n_Shortcut are combined into a single "Specific_Error" state of the module and output to the IO LED as "module-specific error".

4.14.3.6 Conversion time

Module AO4 has a set cycle time of 320µs that is not affected by the number of active channels. (The cycle time is the time between receipt of the output values and the start of the D/A converters.)

4.14.4 Technical data

Analogue outputs.....	4
Resolution	16 bit, 12 bit
Measuring range	0 ... 10V, ± 10V, 0...20mA, ± 20mA
Output frequency	3.125 kHz
Connector IO/Power	Plug 18-pole (not part of the module)
Controller	ASIC ET1200
Baud rate	100 Mbit/s
E-bus port	10-pin system plug in side wall
Term. module.....	not required
Power supply	24 VDC -20% +25%
E-bus load.....	150mA
Part no.	694.442.52 16 bit (planned)
Part no.	694.442.02 12 bit

4.15 AI4-Pt/Ni100, AI4-Pt/Ni1000

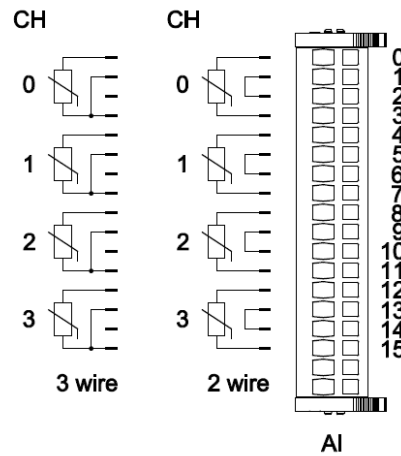
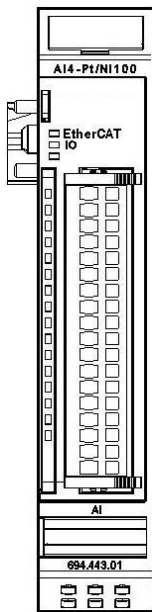

Figure 41: I/O connection

Figure 42: Front view of Pt/Ni100 I/O module

4.15.1 Terminals

The module needs no separate 24V connector. Power is supplied to the module through the E-bus connector.

Operative earth / shielding of analog wires → section 3.1.1



Information – new module version V2.0

The version 2.0 of the modules

Kuhnke FIO AI4-Pt/Ni100 (694 443 01) and

Kuhnke FIO AI4-Pt/Ni1000 (694 443 03) are compatible with their predecessor versions.

However, due to the hardware change, the following changes of the properties result:

- In the Pt100 and Ni100 operating mode, the error message "Input High" is not output if no temperature sensor is connected. If the wiring is correct (2-wire connection with bridge or 3-wire connection), the errors are detected/displayed correctly.
- Measuring range

Sensor	Old Version	From version 2.0
Pt/Ni 100	70...330 Ohm	70...320 Ohm
Pt/Ni 1000	700...3000 Ohm	700...3200 Ohm

4.15.2 Status LEDs

4.15.2.1 "EtherCAT" LED

4.15.2.2 The LED labeled "EtherCAT" indicates the state of the EtherCAT ASIC.

State	LED flash code	Explanation
Init	Red, on	Initialization, no data exchange
Pre-Op	Red/green, 1:1	Pre-operational, no data exchange
Safe-Op	Red/green, 5:1	Safe operation, inputs readable
Op	Green, on	Operational, unrestricted data exchange

4.15.2.3 "IO" LED

The LED labeled "IO" indicates the state of the module's I/Os.

State	LED flash code	Explanation
Ok	Green, on	No error
Error	Off	Malfunction of module if E-bus LED = On Inoperative if E-bus LED = Off
	Red, 4x	EtherCAT watchdog control
	Red, 6x	Module-specific fault
	Red, 7x	Configuration error (E-bus pre-operational), no. of process data differs from that in the module
Defective	Red, on	Module defective

4.15.2.4 "Power" LED

There is no LED labeled "Power" because a separate power feed is not required.

4.15.2.5 "Channel" LEDs

State	LED flash code	Explanation
On	Green, on	Channel enabled
Off	Off	Channel disabled
Error	Red	Short circuit, broken wire

4.15.3 Function

Module AI4-Pt/Ni100 has 4 analogue inputs for Pt100 or Ni100 temperature sensors.

It can also measure resistances between 70 and 330 Ω .
(V2.0 - 70...320 Ω)

Module AI4-Pt/Ni1000 has 4 analogue inputs for Pt1000 or Ni1000 temperature sensors.

It can also measure resistances between 700 and 3000 Ω .
(V2.0 - 700...3200 Ω)

The letter 'n' in the tables below represents the channel number (n=0...7).

4.15.3.1 Analogue inputs

Check the following variable for the digitized input values:

Variable	Data type	Explanation		
Channel_n	INT	Value measured on channel n (n= 0...3)		
		Default	as 1/10 °C	
		ResMode	Pt100	as 1/100 Ω
			Pt1000	as 1/10 Ω

4.15.3.2 Module control

The module provides you with various operational options.

- To set up the module choose the options as appropriate and accept by setting control bit "SetOptions" to a rising edge. The module will confirm by returning "OptionsSet".

There are various "module error" bits that the module uses to indicate errors. The states of the error bits are retained and also used for error indication by the "IO" LED.

- To reset the error bits set control bit "ResetError" to a rising edge.

Variable	Data type	Explanation
SetOptions	BOOL	Rising edge → accepts module options
ResetError	BOOL	Rising edge → acknowledges error

4.15.3.3 Module options

The following options are available for module AI8-Pt/Ni100

Variable	Data type	Explanation
Channel_n_Ni	BOOL	Set channel n to Ni100 sensors
Channel_n_On	BOOL	Enables channel n
Channel_n_ResMode	BOOL	Set channel n to resistance mode
Channel_n_Filter	USINT	Set filter for channel n. The arithmetic mean is output after n+1 conversions
n		0 ... 3 Channel number

To set and accept options, see section 4.15.3.2.

4.15.3.4 Module state

The following module states are indicated:

Variable	Data type	Explanation
Shortcut	BOOL	not used
Undervoltage	BOOL	not used
Watchdog	BOOL	Internal watchdog of module
EtherCAT_Error	BOOL	Configuration error or watchdog control
Specific_Error	BOOL	Module-specific fault
OptionsSet	BOOL	Sent by module to acknowledge SetOptions

To reset the messages, see section 4.15.3.2.

4.15.3.5 Module-specific messages

Apart from the module error messages, there is a set of messages containing details about the current state of the module:

Variable	Data type	Explanation
Channel_n_Open	BOOL	- Channel n load is gt minimum - Broken wire of connector 0 * - Broken wire of connector 3 * - Broken wire of connector 0/3 * → Specific_Error = TRUE
Channel_n_Shortcut	BOOL	- Channel n load is lt minimum - Short circuit of connector 0-3 * - Broken wire of connector 2 * → Specific_Error = TRUE

These messages are automatically reset when the state concerned has returned to normal.

They are combined into a single "Specific_Error" state of the module and output to the IO LED as "module-specific error".

* The causes of 'short circuit' and 'broken wire 0..3' are shown for channel 0 (equivalent applies to other channels)

4.15.3.6 Conversion time

The analogue signals are converted one by one down every channel. Disabling one or several channels will shorten the entire A/D conversion cycle. 'Filter' in this case means to compute an average when the set filter time is over.

Analogue value conversion runs cyclically and is not synchronized with the receipt of EtherCAT telegrams. The cycle consists of the analogue value conversion plus transmitting the values into the EtherCAT data area.

Number of channels	Cycle time in ms
1	32
2	65
3	97
4	129



If you are aiming for a high sampling frequency, the EtherCAT master should do the filtering (averaging) because it will normally have much more processing power.



Take the EtherCAT cycle into account to assess how much the values stored by the EtherCAT master are up-to-date. The module described in this section will accept the above times as the ideal EtherCAT cycle setup.

4.15.3.7 Quality of analogue values



Best results are obtained by
- connecting the shield of the signal cables to operative earth

4.15.4 Technical data

AI4-Pt/Ni100

Analogue inputs.....	4
Resolution	16 bit (resistance 0.01 Ω , temperature 0.1 $^{\circ}$ C)
Pt100 measuring range	- 75 $^{\circ}$ C...+ 670 $^{\circ}$ C
Ni100 measuring range	- 60 $^{\circ}$ C...+ 250 $^{\circ}$ C
Resistance.....	70...330 Ω (V2.0 - 70...320 Ω)
Temperature drift	< \pm 50ppm/ $^{\circ}$ C regarding range limit
Critical frequency.....	typical 2 Hz
Measurement current	< 0,50 mA
Sampling frequency	> 7,75 Hz (if all channels are enabled)
Connector IO/Power.....	Plug 18-pole (not part of the module)
Controller	ASIC ET1200
Baud rate.....	100 Mbit/s
E-bus port.....	10-pin system plug in side wall
Term. module	not required
Power supply	24 VDC -20% +25%
E-bus load	150mA
Part no.....	694.443.01

AI4-Pt/Ni1000

Analogue inputs.....	4
Resolution	16 bit (resistance 0.1 Ω , temperature 0.1 $^{\circ}$ C)
Pt100 measuring range	- 75 $^{\circ}$ C...+ 570 $^{\circ}$ C
Ni100 measuring range	- 60 $^{\circ}$ C...+ 250 $^{\circ}$ C
Resistance.....	70...3000 Ω (V2.0 - 700...3200 Ω)
Temperature drift	< \pm 60ppm/ $^{\circ}$ C regarding range limit
Critical frequency.....	typical 2 Hz
Measurement current	< 0,12 mA
Sampling frequency	> 7,75 Hz (if all channels are enabled)
Connector IO/Power.....	Plug 18-pole (not part of the module)
Controller	ASIC ET1200
Baud rate.....	100 Mbit/s
E-bus port.....	10-pin system plug in side wall
Term. module	not required
Power supply	24 VDC -20% +25%
E-bus load	150mA
Part no.....	694.443.03

4.16 AI8-Pt/Ni100, AI8-Pt/Ni1000

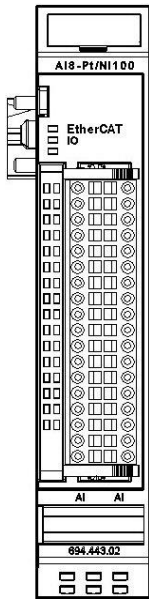

Figure 44: Front view of Pt/Ni100 I/O module

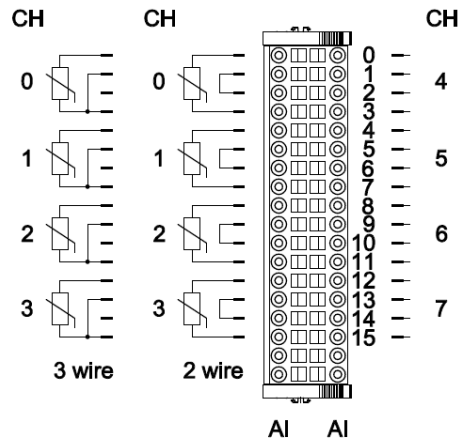

Figure 43: I/O connection

4.16.1 Terminals

The module needs no separate 24V connector. Power is supplied to the module through the E-bus connector.

Operative earth / shielding of analog wires → section 3.1.1



Information – new module version V2.0

The version 2.0 of the modules

Kuhnke FIO AI8-Pt/Ni100 (694 443 02) and

Kuhnke FIO AI8-Pt/Ni1000 (694 443 04) are compatible with their predecessor versions.

However, due to the hardware change, the following changes of the properties result:

- In the Pt100 and Ni100 operating mode, the error message "Input High" is not output if no temperature sensor is connected. If the wiring is correct (2-wire connection with bridge or 3-wire connection), the errors are detected/displayed correctly.
- Measuring range

Sensor	Old Version	From version 2.0
Pt/Ni 100	70...330 Ohm	70...320 Ohm
Pt/Ni 1000	700...3000 Ohm	700...3200 Ohm

4.16.2 Status LEDs

4.16.2.1 "EtherCAT" LED

4.16.2.2 The LED labeled "EtherCAT" indicates the state of the EtherCAT ASIC.

State	LED flash code	Explanation
Init	Red, on	Initialization, no data exchange
Pre-Op	Red/green, 1:1	Pre-operational, no data exchange
Safe-Op	Red/green, 5:1	Safe operation, inputs readable
Op	Green, on	Operational, unrestricted data exchange

4.16.2.3 "IO" LED

The LED labeled "IO" indicates the state of the module's I/Os.

State	LED flash code	Explanation
Ok	Green, on	No error
Error	Off	Malfunction of module if E-bus LED = On Inoperative if E-bus LED = Off
	Red, 4x	EtherCAT watchdog control
	Red, 6x	Module-specific fault
	Red, 7x	Configuration error (E-bus pre-operational), no. of process data differs from that in the module
Defective	Red, on	Module defective

4.16.2.4 "Power" LED

There is no LED labeled "Power" because a separate power feed is not required.

4.16.2.5 "Channel" LEDs

State	LED flash code	Explanation
On	Green, on	Channel enabled
Off	Off	Channel disabled
Error	Red	Short circuit, broken wire

4.16.3 Function

Module AI8-Pt/Ni100 has 8 analogue inputs for Pt100 or Ni100 temperature sensors.

It can also measure resistances between 70 and 330 Ω .
(V2.0 - 70...320 Ω)

Module AI8-Pt/Ni1000 has 8 analogue inputs for Pt1000 or Ni1000 temperature sensors.

It can also measure resistances between 700 and 3000 Ω .
(V2.0 - 700...3200 Ω)

The letter 'n' in the tables below represents the channel number (n=0...7).

4.16.3.1 Analogue inputs

Check the following variable for the digitized input values:

Variable	Data type	Explanation		
Channel_n	INT	Value measured on channel n (n= 0...7)		
		Default	as 1/10 °C	
		ResMode	Pt100	as 1/100 Ω
			Pt1000	as 1/10 Ω

4.16.3.2 Module control

The module provides you with various operational options.

- To set up the module choose the options as appropriate and accept by setting control bit "SetOptions" to a rising edge. The module will confirm by returning "OptionsSet".

There are various "module error" bits that the module uses to indicate errors. The states of the error bits are retained and also used for error indication by the "IO" LED.

- To reset the error bits set control bit "ResetError" to a rising edge.

Variable	Data type	Explanation
SetOptions	BOOL	Rising edge → accepts module options
ResetError	BOOL	Rising edge → acknowledges error

4.16.3.3 Module options

The following options are available for module AI8-Pt/Ni100

Variable	Data type	Explanation
Channel_n_Ni	BOOL	Set channel n to Ni100 sensors
Channel_n_On	BOOL	Enables channel n
Channel_n_ResMode	BOOL	Set channel n to resistance mode
Channel_n_Filter	USINT	Set filter for channel n. The arithmetic mean is output after n+1 conversions
n		0 ... 7 Channel number

To set and accept options, see section 4.16.3.2.

4.16.3.4 Module state

The following module states are indicated:

Variable	Data type	Explanation
Shortcut	BOOL	not used
Undervoltage	BOOL	not used
Watchdog	BOOL	Internal watchdog of module
EtherCAT_Error	BOOL	Configuration error or watchdog control
Specific_Error	BOOL	Module-specific fault
OptionsSet	BOOL	Sent by module to acknowledge SetOptions

To reset the messages, see section 4.16.3.2.

4.16.3.5 Module-specific messages

Apart from the module error messages, there is a set of messages containing details about the current state of the module:

Variable	Data type	Explanation
Channel_n_Open	BOOL	- Channel n load is gt minimum - Broken wire of connector 0 * - Broken wire of connector 3 * - Broken wire of connector 0/3 * → Specific_Error = TRUE
Channel_n_Shortcut	BOOL	- Channel n load is lt minimum - Short circuit of connector 0-3 * - Broken wire of connector 2 * → Specific_Error = TRUE

These messages are automatically reset when the state concerned has returned to normal.

They are combined into a single "Specific_Error" state of the module and output to the IO LED as "module-specific error".

* The causes of 'short circuit' and 'broken wire 0..3' are shown for channel 0 (equivalent applies to other channels)

4.16.3.6 Conversion time

The analogue signals are converted one by one down every channel. Disabling one or several channels will shorten the entire A/D conversion cycle. 'Filter' in this case means to compute an average when the set filter time is over.

Analogue value conversion is not synchronized with the receipt of EtherCAT telegrams. Analogue value conversion runs cyclically and is not synchronized with the receipt of EtherCAT telegrams. The cycle consists of the analogue value conversion plus transmitting the values into the EtherCAT data area.

Number of channels	Cycle time in ms	Number of channels	Cycle time in ms
1	34	5	162
2	66	6	194
3	98	7	226
4	130	8	258



If you are aiming for a high sampling frequency, the EtherCAT master should do the filtering (averaging) because it will normally have much more processing power.



Take the EtherCAT cycle into account to assess how much the values stored by the EtherCAT master are up-to-date. The module described in this section will accept the above times as the ideal EtherCAT cycle setup.

4.16.3.7 Quality of analogue values



*Best results are obtained by
- connecting the shield of the signal cables to operative earth*

4.16.4 Technical data

AI8-Pt/Ni100

Analogue inputs	8
Resolution	16 bit (resistance 0.01 Ω , temperature 0.1 $^{\circ}$ C)
Pt100 measuring range	- 75 $^{\circ}$ C... + 670 $^{\circ}$ C
Ni100 measuring range	- 60 $^{\circ}$ C... + 250 $^{\circ}$ C
Resistance	70...330 Ω (V2.0 - 70...320 Ω)
Temperature drift	< \pm 50ppm/ $^{\circ}$ C regarding range limit
Critical frequency	typical 2 Hz
Measurement current.....	< 0,50 mA
Sampling frequency	> 3,88 Hz (if all channels are enabled)
Connector IO/Power	Plug 36-pole (not part of the module)
Controller	ASIC ET1200
Baud rate	100 Mbit/s
E-bus port	10-pin system plug in side wall
Term. module.....	not required
Power supply	24 VDC -20% +25%
E-bus load.....	170mA
Part no.	694.443.02

AI8-Pt/Ni1000

Analogue inputs	8
Resolution	16 bit (resistance 0.1 Ω , temperature 0.1 $^{\circ}$ C)
Pt100 measuring range	- 75 $^{\circ}$ C... + 570 $^{\circ}$ C
Ni100 measuring range	- 60 $^{\circ}$ C... + 250 $^{\circ}$ C
Resistance	700...3000 Ω (V2.0 - 700...3200 Ω)
Temperature drift	< \pm 60ppm/ $^{\circ}$ C regarding range limit
Critical frequency	typical 2 Hz
Measurement current.....	< 0,12 mA
Sampling frequency	> 3,88 Hz (if all channels are enabled)
Connector IO/Power	Plug 36-pole (not part of the module)
Controller	ASIC ET1200
Baud rate	100 Mbit/s
E-bus port	10-pin system plug in side wall
Term. module.....	not required
Power supply	24 VDC -20% +25%
E-bus load.....	170mA
Part no.	694.443.04

4.17 AI4-Thermo element

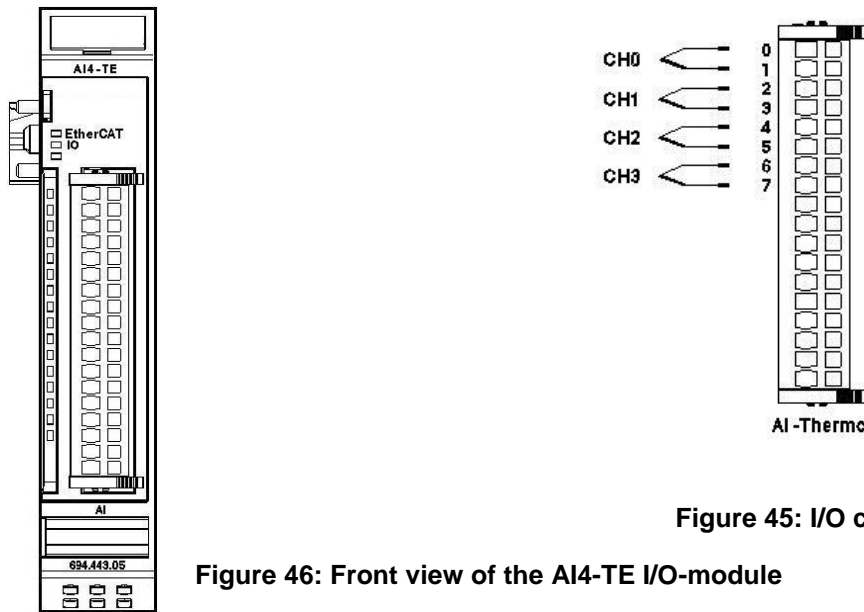

Figure 45: I/O connection

Figure 46: Front view of the AI4-TE I/O-module

4.17.1 Terminals

The module needs no separate 24V connector. Power is supplied to the module through the E-bus connector.

Operative earth / shielding of analog wires → section 3.1.1

4.17.2 Status LEDs

4.17.2.1 "EtherCAT" LED

4.17.2.2 The LED labeled "EtherCAT" indicates the state of the EtherCAT ASIC.

State	LED flash code	Explanation
Init	Red, on	Initialization, no data exchange
Pre-Op	Red/green, 1:1	Pre-operational, no data exchange
Safe-Op	Red/green, 5:1	Safe operation, inputs readable
Op	Green, on	Operational, unrestricted data exchange

4.17.2.3 "IO" LED

The LED labeled "IO" indicates the state of the module's I/Os.

State	LED flash code	Explanation
Ok	Green, on	No error
Error	Off	Malfunction of module if E-bus LED = On Inoperative if E-bus LED = Off
	Red, 4x	EtherCAT watchdog control
	Red, 6x	Module-specific fault
	Red, 7x	Configuration error (E-bus pre-operational), no. of process data differs from that in the module
Defective	Red, on	Module defective

4.17.2.4 "Power" LED

There is no LED labeled "Power" because a separate power feed is not required.

4.17.2.5 "Channel" LEDs

State	LED flash code	Explanation
On	Green, on	Channel enabled
Off	Off	Channel disabled
Error	Red	Short circuit, broken wire

4.17.3 Function

Module AI4-TE has 4 analogue inputs for thermo element sensors.

It can also measure mV-voltages.

The letter 'n' in the tables below represents the channel number (n=0...3).

4.17.3.1 Analogue inputs

Check the following variable for the digitized input values:

Variable	Data type	Explanation	
Channel_n	INT	Measuring value of channel n (n= 0...3)	
		mV-mode	in μV resp. $2\mu\text{V}$
		Default	in $1/10\text{ }^\circ\text{C}$

4.17.3.2 Module control

The module provides you with various operational options.

- To set up the module choose the options as appropriate and accept by setting control bit "SetOptions" to a rising edge. The module will confirm by returning "OptionsSet".

There are various "module error" bits that the module uses to indicate errors. The states of the error bits are retained and also used for error indication by the "IO" LED.

- To reset the error bits set control bit "ResetError" to a rising edge.

Variable	Data type	Explanation
SetOptions	BOOL	Rising edge → accepts module options
ResetError	BOOL	Rising edge → acknowledges error

4.17.3.3 Module options

The following options are available for module AI4-TE

Variable	Data type	Explanation	
Channel_n_SensorType	USINT	Sensor type	
		16#00	mV: not used
		16#10	mV: -40 ..+65mV, Werte in 2µV
		16#04	Typ K: not used
		16#14	Typ K: -200°C .. +1372°C in 0,1°C
Channel_n_On	BOOL	Enables channel n	
Channel_n_Filter	USINT	Set filter for channel n. The arithmetic mean is output after n+1 conversions	
n		0 ... 3 Channel number	

To set and accept options, see section 4.17.3.2.

4.17.3.4 Module state

The following module states are indicated:

Variable	Data type	Explanation
Shortcut	BOOL	not used
Undervoltage	BOOL	not used
Watchdog	BOOL	Internal watchdog of module
EtherCAT_Error	BOOL	Configuration error or watchdog control
Specific_Error	BOOL	Module-specific fault
OptionsSet	BOOL	Sent by module to acknowledge SetOptions

To reset the messages, see section 4.17.3.2.

4.17.3.5 Module-specific messages

Apart from the module error messages, there is a set of messages containing details about the current state of the module:

Variable	Data type	Explanation
Channel_n_Out_of_Range	BOOL	Measuring value is out of range

These messages are automatically reset when the state concerned has returned to normal.

They are combined into a single "Specific_Error" state of the module and output to the IO LED as "module-specific error".

* The causes of 'short circuit' and 'broken wire 0..3' are shown for channel 0 (equivalent applies to other channels)

4.17.3.6 Conversion time

The analogue signals are converted one by one down every channel. Disabling one or several channels will shorten the entire A/D conversion cycle. 'Filter' in this case means to compute an average when the set filter time is over.

Analogue value conversion runs cyclically and is not synchronized with the receipt of EtherCAT telegrams. The cycle consists of the analogue value conversion plus transmitting the values into the EtherCAT data area.

Number of channels	Cycle time in ms
1	35
2	67
3	99
4	131



If you are aiming for a high sampling frequency, the EtherCAT master should do the filtering (averaging) because it will normally have much more processing power.



Take the EtherCAT cycle into account to assess how much the values stored by the EtherCAT master are up-to-date. The module described in this section will accept the above times as the ideal EtherCAT cycle setup.

4.17.3.7 Quality of analogue values



*Best results are obtained by
- connecting the shield of the signal cables to operative earth*

4.17.4 Technical data

AI4-TE	
Analogue inputs	4
Resolution	16 bit
mV measuring range	mV: -40 ..+65mV, in 2 μ V
Type K measuring range ...	Type K: -200°C .. +1372°C in 0,1°C
Measurement failure (25°C) less measurement failure	< \pm 0,4% regarding range limit on demand
Cold junction compensation	yes
Critical frequency	typical 0,33 Hz
Sampling frequency	> 7,63 Hz (if all channels are enabled)
Connector IO/Power	Plug 18-pole (not part of the module)
Controller	ASIC ET1200
Baud rate	100 Mbit/s
E-bus port	10-pin system plug in side wall
Term. module.....	not required
Power supply	24 VDC -20% +25%
E-bus load.....	150mA
Part no.	694.443.05

4.18 AI8-Thermo element

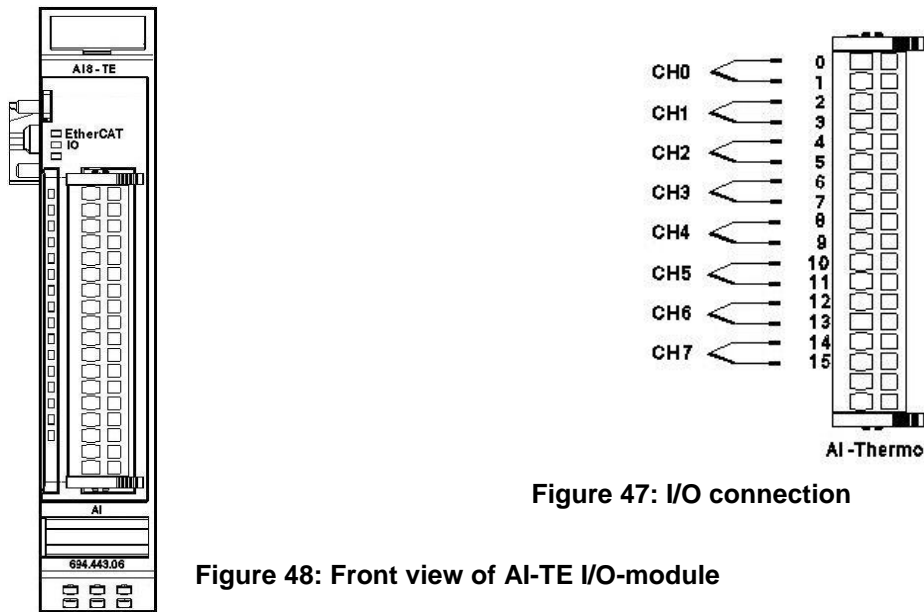

Figure 47: I/O connection

Figure 48: Front view of AI-TE I/O-module

4.18.1 Terminals

The module needs no separate 24V connector. Power is supplied to the module through the E-bus connector.

Operative earth / shielding of analog wires → section 3.1.1

4.18.2 Status LEDs

4.18.2.1 "EtherCAT" LED

4.18.2.2 The LED labeled "EtherCAT" indicates the state of the EtherCAT ASIC.

State	LED flash code	Explanation
Init	Red, on	Initialization, no data exchange
Pre-Op	Red/green, 1:1	Pre-operational, no data exchange
Safe-Op	Red/green, 5:1	Safe operation, inputs readable
Op	Green, on	Operational, unrestricted data exchange

4.18.2.3 "IO" LED

The LED labeled "IO" indicates the state of the module's I/Os.

State	LED flash code	Explanation
Ok	Green, on	No error
Error	Off	Malfunction of module if E-bus LED = On Inoperative if E-bus LED = Off
	Red, 4x	EtherCAT watchdog control
	Red, 6x	Module-specific fault
	Red, 7x	Configuration error (E-bus pre-operational), no. of process data differs from that in the module
Defective	Red, on	Module defective

4.18.2.4 "Power" LED

There is no LED labeled "Power" because a separate power feed is not required.

4.18.2.5 "Channel" LEDs

State	LED flash code	Explanation
On	Green, on	Channel enabled
Off	Off	Channel disabled
Error	Red	Short circuit, broken wire

4.18.3 Function

Module AI8-TE has 8 analogue inputs for thermo element sensors.

It can also measure mV-voltages.

The letter 'n' in the tables below represents the channel number (n=0...7).

4.18.3.1 Analogue inputs

Check the following variable for the digitized input values:

Variable	Data type	Explanation	
Channel_n	INT	Measuring value of channel n (n= 0...3)	
		mV-mode	in μV resp. $2\mu\text{V}$
		Default	in $1/10\text{ }^\circ\text{C}$

4.18.3.2 Module control

The module provides you with various operational options.

- To set up the module choose the options as appropriate and accept by setting control bit "SetOptions" to a rising edge. The module will confirm by returning "OptionsSet".

There are various "module error" bits that the module uses to indicate errors. The states of the error bits are retained and also used for error indication by the "IO" LED.

- To reset the error bits set control bit "ResetError" to a rising edge.

Variable	Data type	Explanation
SetOptions	BOOL	Rising edge → accepts module options
ResetError	BOOL	Rising edge → acknowledges error

4.18.3.3 Module options

The following options are available for module AI8-TE

Variable	Data type	Explanation	
Channel_n_SensorType	USINT	Sensor type	
		16#00	mV: not used
		16#10	mV: -40 ..+65mV, Werte in 2µV
		16#04	Typ K: not used
		16#14	Typ K: -200°C .. +1372°C in 0,1°C
Channel_n_On	BOOL	Enables channel n	
Channel_n_Filter	USINT	Set filter for channel n. The arithmetic mean is output after n+1 conversions	
n		0 ... 7 Channel number	

To set and accept options, see section 4.18.3.2.

4.18.3.4 Module state

The following module states are indicated:

Variable	Data type	Explanation
Shortcut	BOOL	not used
Undervoltage	BOOL	not used
Watchdog	BOOL	Internal watchdog of module
EtherCAT_Error	BOOL	Configuration error or watchdog control
Specific_Error	BOOL	Module-specific fault
OptionsSet	BOOL	Sent by module to acknowledge SetOptions

To reset the messages, see section 4.18.3.2.

4.18.3.5 Module-specific messages

Apart from the module error messages, there is a set of messages containing details about the current state of the module:

Variable	Data type	Explanation
Channel_n_Out_of_Range	BOOL	Measuring value is out of range

These messages are automatically reset when the state concerned has returned to normal.

They are combined into a single "Specific_Error" state of the module and output to the IO LED as "module-specific error".

* The causes of 'short circuit' and 'broken wire 0..3' are shown for channel 0 (equivalent applies to other channels)

4.18.3.6 Conversion time

The analogue signals are converted one by one down every channel. Disabling one or several channels will shorten the entire A/D conversion cycle. 'Filter' in this case means to compute an average when the set filter time is over.

Analogue value conversion is not synchronized with the receipt of EtherCAT telegrams. Analogue value conversion runs cyclically and is not synchronized with the receipt of EtherCAT telegrams. The cycle consists of the analogue value conversion plus transmitting the values into the EtherCAT data area.

Number of channels	Cycle time in ms	Number of channels	Cycle time in ms
1	39	5	167
2	71	6	198
3	103	7	230
4	135	8	262



If you are aiming for a high sampling frequency, the EtherCAT master should do the filtering (averaging) because it will normally have much more processing power.



Take the EtherCAT cycle into account to assess how much the values stored by the EtherCAT master are up-to-date. The module described in this section will accept the above times as the ideal EtherCAT cycle setup.

4.18.3.7 Quality of analogue values



*Best results are obtained by
- connecting the shield of the signal cables to operative earth*

4.18.4 Technical data

AI8-TE	
Analogue inputs	8
Resolution	16 bit
mV measuring range	mV: -40 ..+65mV, in 2 μ V
Type K measuring range ...	Type K: -200°C .. +1372°C in 0,1°C
Measurement failure (25°C) less measurement failure	< \pm 0,4% regarding range limit on demand
Cold junction compensation	yes
Critical frequency	typical 0,33 Hz
Sampling frequency	> 3,82 Hz (if all channels are enabled)
Connector IO/Power	Plug 18-pole (not part of the module)
Controller	ASIC ET1200
Baud rate	100 Mbit/s
E-bus port	10-pin system plug in side wall
Term. module.....	not required
Power supply	24 VDC -20% +25%
E-bus load.....	170mA
Part no.	694.443.06

4.19 RS232 1 Port

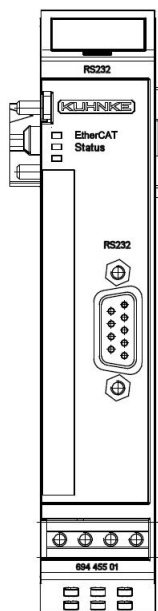

Figure 50: Front view of the RS232 1 Port module

Pin	Signal	Significance
1		not connected
2	TxD	Transmit data
3	RxD	Receive data
4		not connected
5	DGND	Data ground (reference potential for TxD/RxD)
6		not connected
7		not connected
8		not connected
9		not connected

Figure 49: Pinning RS232

4.19.1 Terminals



The module needs no separate 24V connector. Power is supplied to the module through the E-bus connector.

Operative earth / shielding of analog wires → chapter 3.1.1

The RS232 module has a RS232-slave pinning.

A PC connection can be operated by a 1:1 cable with 9-pole D-SUB-plugs e.g. for testing with MS Hyper terminal.

4.19.2 Status LEDs

4.19.2.1 "EtherCAT" LED

4.19.2.2 The "EtherCAT"-LED indicates the state of the EtherCAT-ASICs.

State	LED flash code	Explanation
Init	Red, on	Initialization, no data exchange
Pre-Op	Red/green, 1:1	Pre-operational, no data exchange
Safe-Op	Red/green, 5:1	Safe operation, inputs readable
Op	Green, on	Operational, unrestricted data exchange

4.19.2.3 LED "Status"

The LED labeled "Status" indicates the state of the module regarding RS232.

State	LED flash code	Explanation
Ok	Green, on	No error
Error	Red, Flashlight	Connection fault
Start, Defect	Red, on	Module is not initialised

4.19.3 Function

The module RS232 1 Port is an EtherCAT/RS232 gateway. It accomplishes the data transfer between an EtherCAT system and a device with RS232 interface.

4.19.3.1 RS232 Data

Utilizable receive data you will find in 4 groups of input variables:

Variable	Data type	Number	Explanation
InByteM1_0 .. _15	USINT	16	Input data module1 Byte_0 ..Byte_15
InByteM2_0 .. _31	USINT	32	Input data module2 Byte_0 ..Byte_31
InByteM3_0 .. _47	USINT	48	Input data module3 Byte_0 ..Byte_47
InByteM4_0 .. _63	USINT	64	Input data module4Byte_0 ..Byte_63

Utilizable send data you will find in 4 groups of output variables:

Variable	Data type	Number	Explanation
OutByteM1_0 .. _15	USINT	16	Output data module1 Byte_0 ..Byte_15
OutByteM2_0 .. _31	USINT	32	Output data module2 Byte_0 ..Byte_31
OutByteM3_0 .. _47	USINT	48	Output data module3 Byte_0 ..Byte_47
OutByteM4_0 .. _63	USINT	64	Output data module4 Byte_0 ..Byte_63

See chapter 4.19.3.11 at p. 92 for configuring the data modules.

4.19.3.2 Module control

The first Out-Byte is responsible for sending commands to the module and access control of the mailboxes.

"MBXout Kontrolle" is a group of boolean output variables:

Variable	Data type	Explanation
command1	BOOL	Command (see chapter 4.19.3.5 etc.)
command2	BOOL	
command3	BOOL	
command4	BOOL	
reserved	BOOL	not used
MBXoutBit	BOOL	access control for the output data mailbox
MBXinBit	BOOL	access control for the input data mailbox
Reset	BOOL	

The first In-Byte is responsible for the response of the module after receiving a command and the access control of the mailboxes.

"MBXin Kontrolle" is a group of boolean input variables:

Variable	Data type	Explanation
Response1	BOOL	Response (see chapter 4.19.3.5 etc.)
Response2	BOOL	
Response3	BOOL	
Response4	BOOL	
ErrorInd	BOOL	Error indicator
MBXoutBit	BOOL	access control for the output data mailbox
MBXinBit	BOOL	access control for the input data mailbox
Reset	BOOL	

4.19.3.3 Number of Data

"Anzahl Daten" is a group with the output variable "Length".

The output variable "Length" defines the number of bytes, which has to be sent as utilizable data.

Variable	Data type	Explanation
Length	USINT	Number of send data

"Anzahl Daten" is a group with the input variable "Length".

The input variable "Length" defines the number of bytes received over RS232 and made available by the module to be sent as utilizable data to the EtherCAT master.

Variable	Data type	Explanation
Length	USINT	Number of receive data

4.19.3.4 Mailboxes, Master-Slave

Data exchange is operated over 2 mailboxes. They realize the full-duplex transmission up to the CoDeSys application. In order to ensure the perfect operation even with higher Baud rates, the size of the mailboxes i.e. the process image is configurable. Receive mailbox and send mailbox have the following structure:

Variable	Byte	Bit7	Bit6	Bit5	Bit4	Bit3	Bit2	Bit1	Bit0
MBXin/out Kontrolle	0	Reset	res ¹	ind ²	Error	Command/Response			
AnzahlDaten: Length	1	Number of the following bytes							
RS232 Daten...	2	Send-/Receive data byte 0							
							
	n	Send-/Receive data byte n-2							

The communication between the EtherCAT-master PLC (Master) and the RS232-module (Slave) is operated by using a protocol. Thereby the value of Command (Bit0..Bit3 of MBXout) is crucial for that, was the module has to do. The module responds with Response in MBXin.

Command	Function
0	Initialization of the mailboxes
4	Setting of the options
6	Write data from master to slave (send)
7	Write data from slave to master (receive)
8	Request of error information

4.19.3.5 Initialization of the mailboxes: Command=0

For initialization the master sends command 0:

Variable	Byte	Bit7	Bit6	Bit5	Bit4	Bit3	Bit2	Bit1	Bit0
MBXout Kontrolle	0	1	0	0	0	0x00			
AnzahlDaten: Length	1	0							

¹ response, bit for mailbox access control

² indication, bit for mailbox access control

The Slave responds with the echoplexing of the command, i.e Response=0x00.

Variable	Byte	Bit7	Bit6	Bit5	Bit4	Bit3	Bit2	Bit1	Bit0
MBXin Kontrolle	0	1	0	0	0	0x00			
AnzahlDaten: Length	1	0x80							

4.19.3.6 Access control of the mailboxes

The further controlling of the mailboxes is operated over these four bits:

Group	Bit	Bool-Variable	Byte-Variable	Mailbox
MBXout Kontrolle	5	MBXoutBit	MBXout.ind	Output data
	6	MBXinBit	MBXout.res	Input data
MBXin Kontrolle	5	MBXoutBit	MBXin.ind	Output data
	6	MBXinBit	MBXin.res	Input data

Master may write, writes and closes the write authority:

If MBXout.ind and MBXin.ind are equal, the master may write in the MBXout Mailbox. If it has done it, it will invert MBXout.ind.

Thus MBXout.ind and MBXin.ind are different and the master may not write any more. This mailbox now is sent to the slave.

Slave may read, reads and places write authority::

The Slave indicates, that MBXout.ind and MBXin.ind are different and therefore it gets the permission for reading the mailbox MBXout. After the slave has done this, it inverts MBXin.ind now. Thus MBXout.ind and MBXin.ind became equal again and the slave has no access any more.

The master has the permission to write into the mailbox, again.

The same procedure is done for sending data from the slave to the master, however with roles mixed up and with the bits MBXout.res and MBXin.res.



With the mailbox method the full duplex transmission of the RS232 is transformed on EtherCAT.

Both data directions can be treated by each other completely separated.

4.19.3.7 Setting of the Options: Command=4

For setting the options the master sends command 4:

bSETOPTIONS: Code 0x04

Variable	Byte	Bit7	Bit6	Bit5	Bit4	Bit3	Bit2	Bit1	Bit0
MBXout Kontrolle	0	Reset	res	in	Error	0x04			
AnzahlDaten: Length	1	4							
	2	Code for baud rate							
	3	Code for mode							
	4	Size of the mailboxes							
	5	1=XON,XOFF-Protocoll, else 0							

Code	Baudrate
0	1200
1	2400
2	4800
3	9600
4	19200
5	38400
6	57600
7	115200

Code	Mode	Bit	Abbreviation
0	7E1	8	Data bits: 7 or 8 Parity: E=Even O=Odd N=No Stop bits: 1 or 2
1	7O1	8	
2	7E2	9	
3	7O2	9	
4	8N1	9	
5	8E1	9	
6	8O1	9	
7	8N2	10	

After receiving this command the module initializes the interface newly.
The master gets the response 0x05 from the module:

bOPTIONSSET: Code 0x05

Variable	Byte	Bit7	Bit6	Bit5	Bit4	Bit3	Bit2	Bit1	Bit0
MBXin Kontrolle	0	Reset	res	in	Error	0x05			
AnzahlDaten: Length	1	0							

4.19.3.8 Write Data (Send): Command=6

For writing data the master sends command 6:

bWRITE : Code 0x06

Variable	Byte	Bit7	Bit6	Bit5	Bit4	Bit3	Bit2	Bit1	Bit0
MBXout Kontrolle	0	Reset	res	in	Error	0x06			
AnzahlDaten: Length	1	n							
OutByteM1_0	2	1. data byte							
OutByteM?_?		...							
OutByteM?_?	n+2	n-th data byte							

4.19.3.9 Read Data (receive): Command=7

If the module has received data from the RS232, it will offer these for reading by the master. That is done by Response 7.

bREAD: Code 0x07

Variable	Byte	Bit7	Bit6	Bit5	Bit4	Bit3	Bit2	Bit1	Bit0
MBXin Kontrolle	0	Reset	res	in	Error	0x07			
AnzahlDaten: Length	1	n							
InByteM1_0	2	1. data byte							
InByteM?_?		...							
InByteM?_?	n+2	n-th data byte							



If the master does not collect the data, an overflow can arise.

Only with XON, XOFF protocol it is possible to stop the data interchange with the RS232 partner.

4.19.3.10 Request of error information: Command=8

For requesting error information the master sends command 8.

bGETERRORS : Code 0x08

Out-Variable	Byte	Bit7	Bit6	Bit5	Bit4	Bit3	Bit2	Bit1	Bit0
MBXout Kontrolle	0	Reset	res	in	Error	0x08			
AnzahlDaten: Length	1	0							

The master gets the response 0x05 from the module and error information in 6 data bytes.

bGETERRORS : Code 0x09

In-Variable	Byte	Bit7	Bit6	Bit5	Bit4	Bit3	Bit2	Bit1	Bit0
MBXin Kontrolle	0	Reset	res	in	Error	0x09			
AnzahlDaten: Length	1	6							
InByteM1_0	2	Error flags (see next table)							
InByteM1_1	3	0							
InByteM1_2	4	number of overflows, Low byte							
InByteM1_3	5	number of overflows, High byte							
InByteM1_4	6	number of parity-errors, Low byte							
InByteM1_5	7	number of parity-errors, High byte							

Errorflags:

Bit	Explanation
0	Overflow
1	Parity
2	Wrong Baudrate
3	Mode is not supported
4	-
5	-
6	-
7	-

4.19.3.11 Konfigurierung der Datenmodule für EtherCAT

You need KuhnkeRS232Modul.xml for the EtherCAT configuration. This is to be imported in the EtherCAT master configurator which can be used.

(See also section 6 at page 138.)



Online-configuration (Scan Boxes = Reading of the configuration data from the connected EtherCAT devices) is not possible because of a too large amount of data).

Example:

Ventura EC2 as EtherCAT-Master, configuration with the EtherCAT-configurator in CoDeSys 2.3.

For the configuration of the EtherCAT appropriate PDOs are available.

Index	Input variable	Index	Output variable
0x1A01	MBXin Kontrolle	0x1601	MBXout Kontrolle
0x1A02	Anzahl Daten	0x1602	Anzahl Daten
0x1A03	RS232 Daten InByteM1_0 .. _15	0x1603	RS232 Daten OutByteM1_0 .. _15
0x1A04	RS232 Daten InByteM2_0 .. _31	0x1604	RS232 Daten OutByteM2_0 .. _31
0x1A05	RS232 Daten InByteM3_0 .. _47	0x1605	RS232 Daten OutByteM3_0 .. _47
0x1A06	RS232 Daten InByteM4_0 .. _63	0x1606	RS232 Daten OutByteM4_0 .. _63

- Start the EtherCAT configurator by pressing the push button "Configurator".
You will get more expressive variable names by using the option "Use group names". (since Target_VenturaEC2_V05)

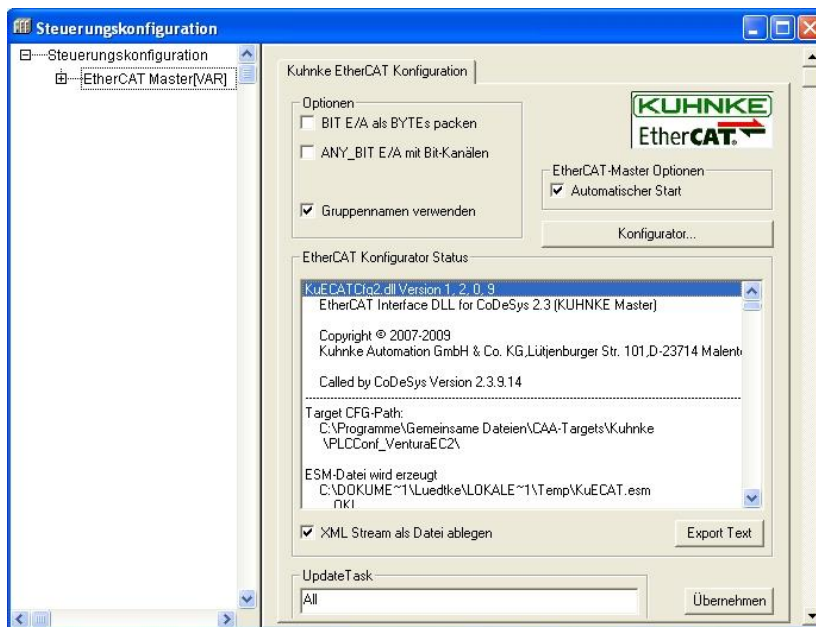

Output data:

- After you inserted the "RS232 1 Port Modul (694.455.01)" into the configuration, change on the right side into the field "Sync Manager". Click on the line "Outputs", so that the PDO Assignment for the output PDOs appears.
- Meet the selection, by marking/demarking the check boxes:

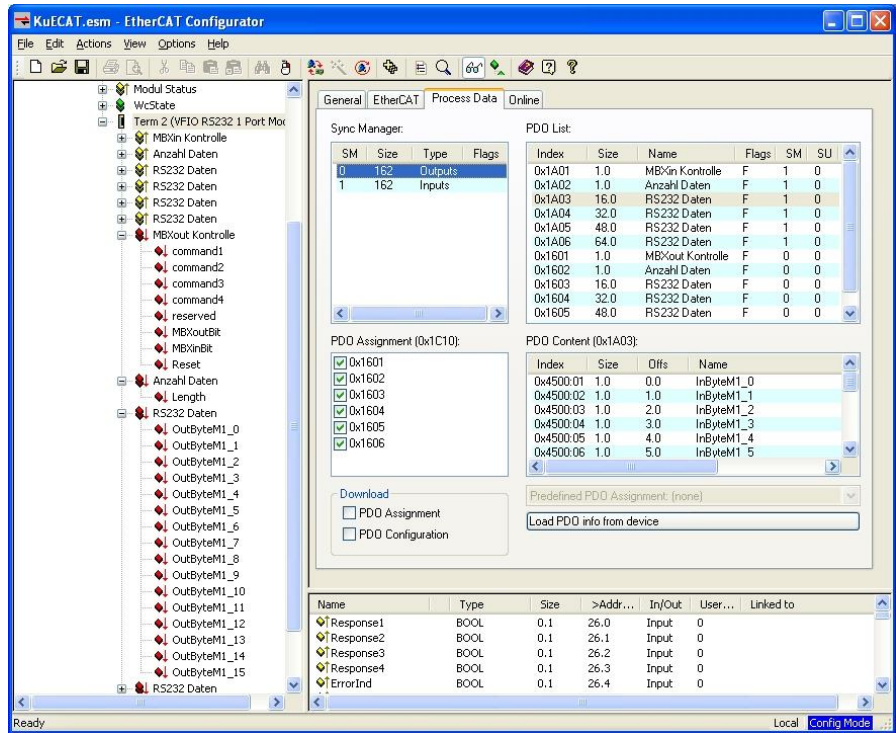

Input data:

- Click on the line "Inputs", so that the PDD assignment for the input PDOs appears.
- Meet the selection, by marking/demarking the check boxes:

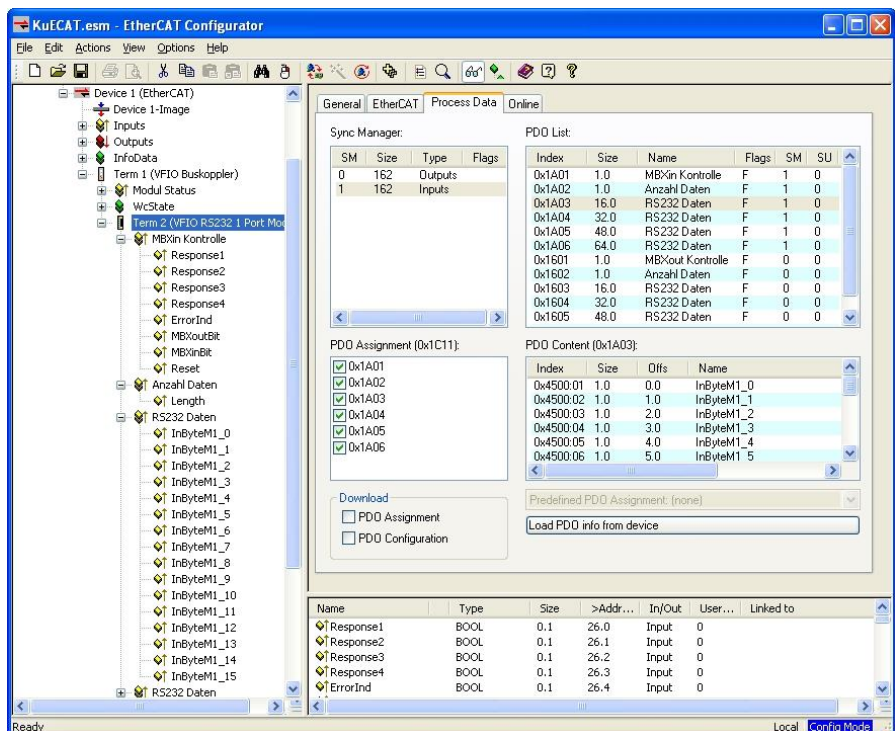

By this method a reducing of the data length is possible



It makes sense that configuring on the EtherCAT input data side and the output data are implemented identically.

4.19.4 Technical Data

RS232 1 Port

Fieldbus1 (System)EtherCAT 100 Mbit/s
EtherCAT-FileKuhnkeRS232Modul.xml

Serial interfaceRS232
Connector RS232.....D-SUB Plug 9-pole, male (not part of the module)
Baud rate.....1200 .. 115200 bit/s

WxHxD25x120x90 mm
Montage35mm DIN top hat rail
Controller.....ASIC ET1200
Connection10-pole system plug at the side
End modulenot necessary
Power supply.....from EtherCAT-Coupler via E-Bus-plug
E-Bus-Load195mA
Galvanic separationSeparated from one another and versus the bus
Storage temperature-25 °C...+70 °C
Operating temperature0°C...+55°C
Relative humidity5%...95% without dewing
ProtectionIP20
Interference immunity.....Zone B
part no.694.455.01

4.20 PROFIBUS-DP-Slave

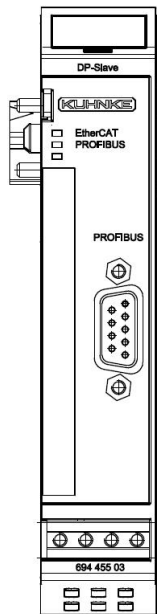

Pin	Signal	Explanation
1	Shield	Shield/functional ground
2	M24	not connected
3	RxD/TxD-P	Receive/Transmit data – plus (B wire)
4	CNTR-P	Repeater control signal (direction control), RTS signal
5	DGND	Data ground (reference potential for VP)
6	VP	Supply voltage - plus (P5V)
7	P24	not connected
8	RxD/TxD-N	Receive/Transmit data – minus (A wire)
9	CNTR-N	Repeater control signal (direction control)

Figure 51: Pinning PROFIBUS

Figure 52: Front view of the PROFIBUS-DP-Slave module

4.20.1 Terminals

The module needs no separate 24V connector. Power is supplied to the module through the E-bus connector.
Operative earth / shielding of analog wires → chapter 3.1.1

4.20.2 Status LEDs

4.20.2.1 "EtherCAT" LED

The "EtherCAT"-LED indicates the state of the EtherCAT-ASICs.

State	LED flash code	Explanation
Init	Off	Initialization, no data exchange
Pre-Op	Off/green, 1:1	Pre-operational, no data exchange
Safe-Op	Off/green, 5:1	Safe operation, inputs readable
Op	Green, on	Operational, unrestricted data exchange

4.20.2.2 LED "PROFIBUS"

The LED labeled "PROFIBUS" indicates the state of the module regarding PROFIBUS.

State	LED flash code	Explanation
Ok	Green, on	No error
Error	Red, Flashlight	Connection fault
Start, Defect	Red, on	Module is not initialised

4.20.3 Function

The module PROFIBUS-DP-Slave is an EtherCAT/PROFIBUS-DP gateway. It accomplishes the data transfer between an EtherCAT system and a PROFIBUS-DP system.

4.20.3.1 Data

Utilizable data you will find in 4 groups of input variables and 4 groups of output variables:

Variable	Data type	Number	Explanation
InByteM1_0 .. _15	USINT	16	Input data module1 Byte_0 ..Byte_15
InByteM2_0 .. _31	USINT	32	Input data module2 Byte_0 ..Byte_31
InByteM3_0 .. _47	USINT	48	Input data module3 Byte_0 ..Byte_47
InByteM4_0 .. _63	USINT	64	Input data module4Byte_0 ..Byte_63
OutByteM1_0 .. _15	USINT	16	Output data module1 Byte_0 ..Byte_15
OutByteM2_0 .. _31	USINT	32	Output data module2 Byte_0 ..Byte_31
OutByteM3_0 .. _47	USINT	48	Output data module3 Byte_0 ..Byte_47
OutByteM4_0 .. _63	USINT	64	Output data module4 Byte_0 ..Byte_63

See chapter 4.20.3.6 at p. 98 for configuring the data modules.

4.20.3.2 Module control

The module provides no operational options but a PROFIBUS-address, which is set by the EtherCAT-master .

The module indicates errors by different "Module state" bits. These error bits are stored. To reset the error bits set control bit "ResetError" to a rising edge.

Variable	Data type	Explanation
SetOptions	BOOL	Rising edge → accepts the PROFIBUS address
ResetError	BOOL	Rising edge → acknowledges error

4.20.3.3 SPC3 address

The PROFIBUS-DP-Slave address is set by the following variable:

Variable	Data type	Explanation
Address	USINT	PROFIBUS-DP-Slave address

The assumption of the address is released with the rising edge of SetOption. The execution is indicated with OptionSet.

Since revision 2 the PROFIBUS DP slave address can be changed also at runtime.

4.20.3.4 Module state

The following module states are indicated:

Variable	Data type	Explanation
Shortcut	BOOL	not used
Undervoltage	BOOL	not used
Watchdog	BOOL	Internal watchdog of module
EtherCAT_Error	BOOL	Configuration error or watchdog control
Specific_Error	BOOL	not used
OptionsSet	BOOL	Sent by module to acknowledge SetOptions

To reset the messages, see section 4.19.3.2.

4.20.3.5 Module-specific messages

Apart from the module error messages, there is a set of messages containing details about the current state of the module:

Variable	Data type	Explanation
ProfibusRunning	BOOL	PROFIBUS runs

4.20.3.6 Configuring of the data modules

For the configuration of the EtherCAT and the PROFIBUS the appropriate configuration files are needed.

These are:

KuhnkeEtherCATModules.xml for EtherCAT
 KUHN6943.GSD for PROFIBUS

Number and size of the data modules are configurable.

The relationship of input data and output data is always thereby 1:1

- Select the desired data modules in the respective Configurator tools.



Make sure that configuring on the EtherCAT side and the PROFIBUS side must be implemented identically.

4.20.3.6.1 PROFIBUS

For the configuration of the PROFIBUS you need KUHN6943.GSD. This is to be imported into the PROFIBUS-master configurator which can be used.

Example:

Ventura SlotPLC as PROFIBUS-Master, Configuration with CoDeSys 2.3

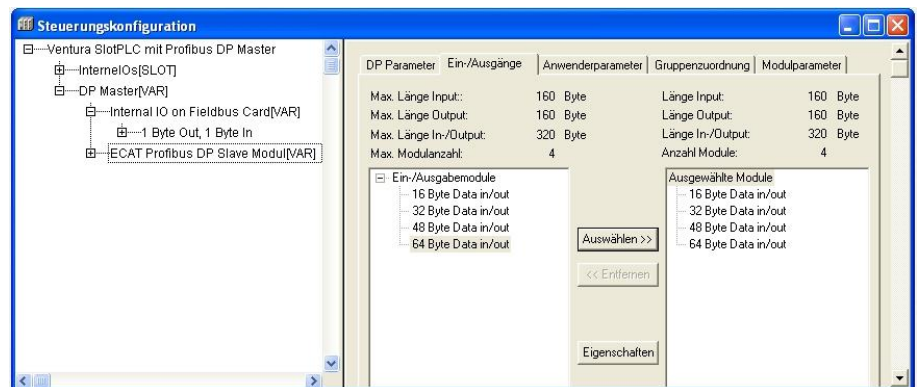

Maximally 4 modules with a maximum data area length of 160 bytes for each direction can be selected.

The individual modules are consistent for itself.

The module provides the following module specific diagnosis data "Ext_Diag_Data":

Octet	Value	Meaning
1..4	...	Standard diagnosis
5	0x43	Standard diagnosis: Module Id.# 6943
6	0x69	
7	3	3 (1+2) Byte extended Diagnose
8	0	EtherCAT is running
	6	EtherCAT Error
9	0x11	Revision 1
	0x12	Revision 2 (with DP-address change)

4.20.3.6.2 EtherCAT

You need KuhnkeProfibusModul.xml for the EtherCAT configuration. This is to be imported in the EtherCAT master configurator which can be used.
(See also section 6 at page 138.)



Online-configuration (Scan Boxes = Reading of the configuration data from the connected EtherCAT devices) is not possible because of a too large amount of data).

Example:

Ventura EC2 as EtherCAT-Master, configuration with the EtherCAT-configurator in CoDeSys 2.3.

For the configuration of the EtherCAT appropriate PDOs are available.

Index	Input variable	Index	Output variable
0x1601	ModulKontrolle	0x1A01	ModulStatus
0x1602	Modulspezifische Meldungen	0x1A02	SPC3address_Adress
0x1603	Profibusdata_InByteM1_0 .. _15	0x1A03	Profibusdata_OutByteM1_0 .. _15
0x1604	Profibusdata_InByteM2_0 .. _31	0x1A04	Profibusdata_OutByteM2_0 .. _31
0x1605	Profibusdata_InByteM3_0 .. _47	0x1A05	Profibusdata_OutByteM3_0 .. _47
0x1606	Profibusdata_InByteM4_0 .. _63	0x1A06	Profibusdata_OutByteM4_0 .. _63

- Start the EtherCAT configurator by pressing the push button "Configurator".
You will get more expressive variable names by using the option "Use group names". (since Target_VenturaEC2_V05)

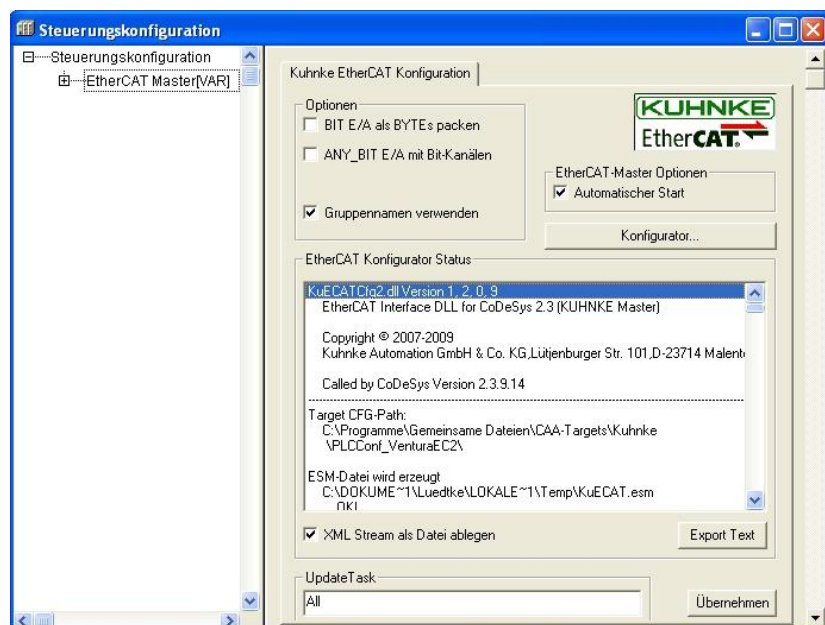
**Output data:**

- After you inserted the PROFIBUS slave module (694.455.03) into the configuration, change on the right side into the field "Sync Manager". Click on the line "Outputs", so that the PDO Assignment for the output PDOs appears.

- Meet the selection, by marking/demarking the check boxes:

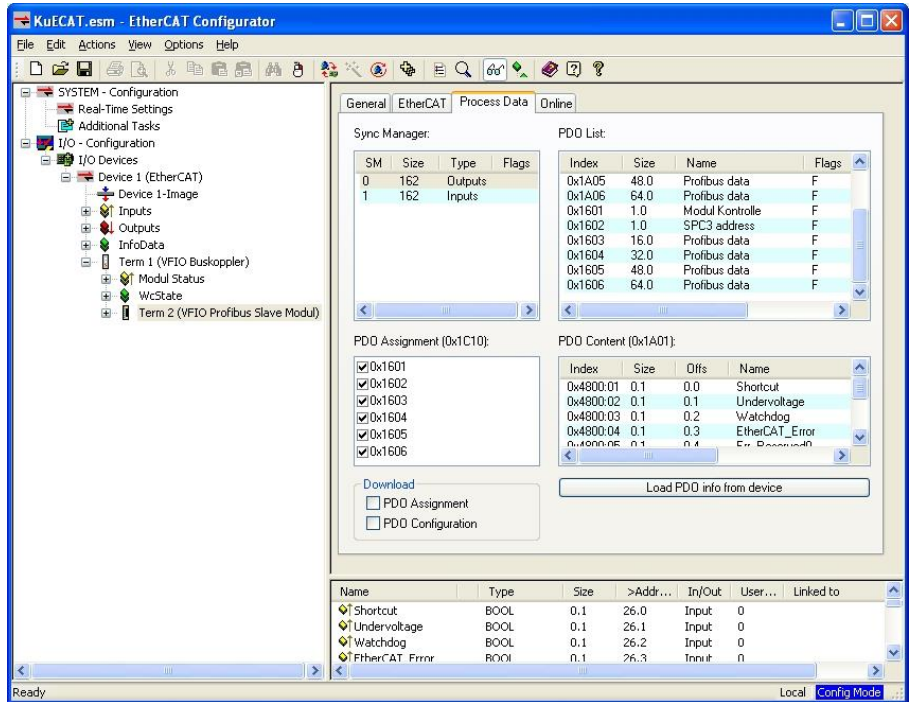

Input data:

- Click on the line "Inputs", so that the PDO assignment for the input PDOs appears.
- Meet the selection, by marking/demarking the check boxes:

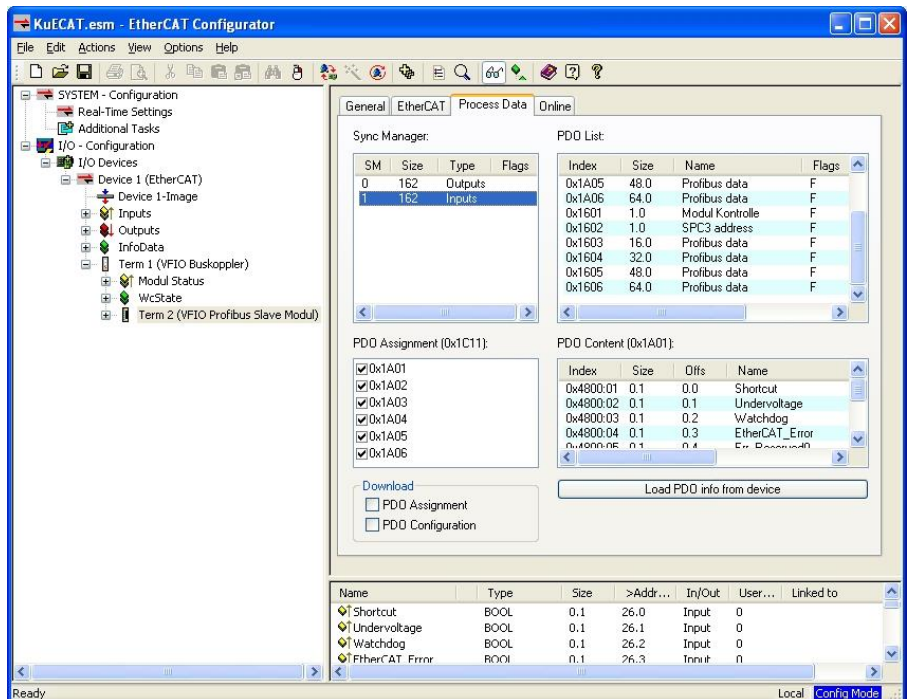

By this method a reducing of the data length is possible



Make sure that configuring on the EtherCAT side and the PROFIBUS side must be implemented identically.

4.20.3.6.3 Selection of the PROFIBUS address

The PROFIBUS address is written into the variable "Address" of the PLC program and transmitted as PDO 1602 to the PROFIBUS-DP-Slave module. With the setting of the bit " SetOptions" the assumption of the address in the module becomes released. The module acknowledges the assumption of the address by setting of " OptionsSet".

After receipt of a valid PROFIBUS address the module initializes the PROFIBUS. If a master accesses the module over the PROFIBUS and transfers a valid configuration, the professional bus is functional. This is indicated by the bit "ProfibusRunning".

Only then data exchange EtherCAT <- -> PROFIBUS is possible.

Since revision 2 the address change at runtime is possible. The connection with the PROFIBUS master will be cut for a short time but the master will rebuild the connection to the new address by its GAP update. The status of the connection is shown in "ProfibusRunning".

Example:

Setting of usiDP_Adresse as DP-Slave address in the CoDeSys PLC Ventura Intime EC2

```
(* Start (Single action) *)
Term2_Address:=usiDP_Adresse;      (* Copying the DP-Slave address *)
Term2_SetOptions_Byte.0:=TRUE;     (* Start of the address setting *)

(* Controlling*)
IF Term2_SetOptions_Byte.0=TRUE THEN
    IF Term2_Shortcut_Byte.7=TRUE THEN (* Wait for confirmation *)
        Term2_SetOptions_Byte.0=FALSE; (* Reset*)
    END_IF
END_IF
```

4.20.4 Technical Data

PROFIBUS-DP-Slave

Fieldbus1 (System)EtherCAT 100 Mbit/s
 EtherCAT-File:.....KuhnkeProfibusModul.xml

 Fieldbus2.....PROFIBUS-DP-Slave
 Implementation typeSPC3
 Connector PROFIBUSD-SUB Plug 9-pole, male
 (not part of the module)
 Baud ratemax 12 Mbit/s,
 - Detectionautomatically
 Addressingvia EtherCAT-Variable
 GSD-File.....KUHN6943.GSD

 WxHxD25x120x90 mm
 Montage35mm DIN top hat rail
 Controller.....ASIC ET1200
 Connection10-pole system plug at the side
 End modulenot necessary
 Power supply.....from EtherCAT-Coupler via E-Bus-plug
 E-Bus-Load210mA
 Galvanic separationSeparated from one another and versus the bus
 Storage temperature-25 °C...+70 °C
 Operating temperature0°C...+55°C
 Relative humidity5%...95% without dewing
 ProtectionIP20
 Interference immunity.....Zone B
 part no.694.455.03

4.21 CounterPosi2 5V, Counter2 5V

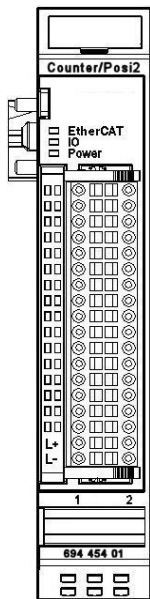

Figure 54: Front view of the Counter2 module

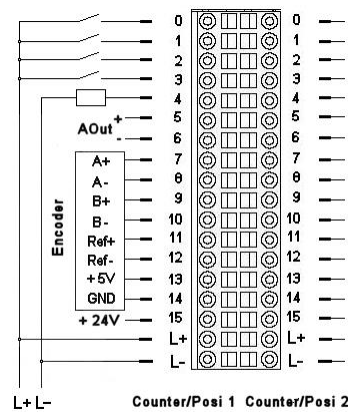

Figure 53: Pinning Counter/Posi2

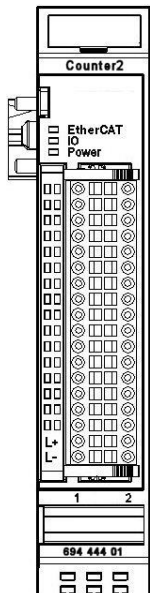

Figure 56: Front view of the Counter2 module

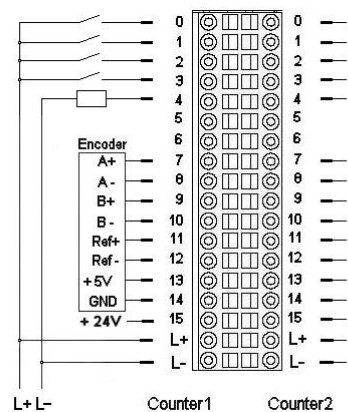

Figure 55: Pinning Counter2

4.21.1 Terminals

Pin	Signal	Explanation
0..3	In_0..3	Digital Inputs
4	Out_0	Digital Output
5..6	A_Out	Analog output (Counter/Posi2 only)
7..12	A, B, Ref	Encoder signals
13..14	5V	Encoder supply 5V (0.2A fuse)
15	n. c.	Initiator supply (0.2A fuse)
16..17	24V	Module supply

* 24V encoders: for >25kHz not used encoder signals connected to +5V

4.21.2 Status LEDs

4.21.2.1 LED "EtherCAT"

The LED labeled "EtherCAT" indicates the state of the EtherCAT ASIC.

State	LED flash code	Explanation
Init	Red, on	Initialization, no data exchange
Pre-Op	Red/green, 1:1	Pre-operational, no data exchange
Safe-Op	Red/green, 5:1	Safe operation, inputs readable
Op	Green, on	Operational, unrestricted data exchange

4.21.2.2 LED "IO"

The LED labeled "IO" indicates the state of the module's I/Os.

State	LED flash code	Explanation
Ok	Green, on	No error
Error	Off	Malfunction of module if E-bus LED = On Inoperative if E-bus LED = Off
	Red, 2 x	Low voltage
	Red, 3 x	Watchdog internal
	Red, 4 x	EtherCAT watchdog control
	Red, 7 x	Configuration error (E-bus pre-operational), no. of process data differs from that in the module
Defective	Red, on	Module defective

4.21.2.3 LED "Power"

The LED labeled "IO" indicates the state of the I/O-supply of the module.

State	LED flash code	Explanation
On	Green, on	24 V DC exists
Off	Off	24 V DC does not exist

4.21.2.4 Status LEDs of the IOs

The Status-LEDs of the several IOs indicate the state of the individual I/Os.

Pin	Voltage	LED	Explanation
0..3	24V	Green	Digital Inputs
4	24V	Green	Digital Outputs
7, 9, 11	5V	Green	Encoder signals A, B, Ref

4.21.3 Function



The module Counter2 has 2 identical channels.

Each channel has terminals for 1 encoder and 4 digital inputs and 1 digital output.

The Counter/Posi2 module has 1 additional analog output.

There are structured groups of variables for:

1. Controlling and watching the entire module:
 - Modul Kontrolle/Modul Status (Module control/Module status)
2. Controlling and watching of Counter 1 resp. 2:
 - Optionen/Kontrolle/Status/Fehler (Options/Control/Status/Errors)
3. Counter values of Counter 1 resp. 2:
 - Sollwerte/Istwerte (Set values/Current values)
4. State of the digital IOs of Counter 1 resp. 2:
 - Digitale Ausgänge/Digitale Eingänge/Eingangsflanken-Zeitstempel/Ausgangsverzögerung (Digital Outputs/Digital Inputs/Input change time stamp/ output delay)

Principle of Kontrolle (Control) and Status:

If a control bit is set (=TRUE), the module will operate the corresponding function due to the rising edge of the bit.

The module indicates the execution of the function by setting the corresponding status bit (=TRUE). When the control bit is reset (=FALSE) the module will also reset the status bit (=FALSE).



In the following the functions of the counter module are described by counter 1. For counter 2 the data are valid accordingly.

4.21.3.1 Frame- or DC-synchronous mode

Dependent on whether Distributed Clocks (DC) are used or not, the module adjusts itself independently on the suitable mode of operation. The module is preset on Frame synchronous mode. With the receipt of the first DC telegram the module is changed over to DC-synchronous mode and maintains this mode of operation up to next switching off.

4.21.3.1.1 Frame-synchronous

The EtherCAT master sends EtherCAT frames with the output data for the module. With the arrival of such frame the output data are taken over and processed by the module. The module places its input data into the EtherCAT frame, so that the master can receive it.

4.21.3.1.2 DC-synchronous

If the module is adjusted to DC-synchronous mode, it produces interrupts according to the rules of the Distributed Clocks DC. The EtherCAT master sends also here EtherCAT Frames away with the output data for the module. With the arrival of such frames the output data of the module are taken over however then processed only if a DC interrupt has occurred. With the DC interrupt the module places its input data into a buffer, from which they are transported with the next EtherCAT Frame to the master.

With this method time-synchronous functions for digital inputs and digital outputs for several modules in 1 EtherCAT network are possible.

See also beginning at page 110 Zähler 1 Eingangsfanken-Zeitstempel (Counter 1 Input Edge Timestamp) and Ausgangsverzögerung (Output Set Delay) (in preparation).

4.21.3.2 Controlling and watching the entire module

The module control is carried out with the variables from the group "Modul Kontrolle". The status of the settings having been carried out becomes shown in the variables of the group "Modul Status".

4.21.3.2.1 Modul Kontrolle (Module Control)

The module does not have any options at present.

The module reports faults with different "Modul Status" bits. These bits are stored. They can be reset only then if the fault is not there any more.

Send a rising edge to "ResetError" to reset the "Modul Status" bits.

Variable	Data type	Explanation
ResetError	BOOL	rising edge → error confirmation

4.21.3.2.2 Modul Status (Module State)

The following module status bits are indicated:

Variable	Data type	Explanation
LowSupplyVoltage	BOOL	Low voltage
Watchdog	BOOL	module internal Watchdog
EtherCAT_Error	BOOL	Configuration error or Timeout

Reset: see 4.21.3.2.1 Modul Kontrolle

4.21.3.3 Controlling/Watching Counter 1

The setting of the functions of the counter is carried out with the variables from the group "Zähler 1 Optionen".

The module control is carried out with the variables from the group "Zähler 1 Kontrolle".

The status of the settings is indicated in the variables of the group "Zähler 1 Status".



The use of the counter module in a variety of different applications is possible by use of the variables from the groups of Zähler 1-Optionen, -Kontrolle and -Status.

4.21.3.3.1 Zähler 1 Optionen (Counter 1 Options)

The module offers you different options for the operation of Counter 1. The options are set in the module with the help of the control bit "SetOptions_1" (see also 4.21.3.3.2 Zähler 1 Kontrolle) and then valid up to the next setting procedure.

- At first select the options, please. For taking over send a rising edge to the control bit "SetOptions_1". The module indicates the execution by "OptionsSet_1=TRUE". When "SetOptions_1" becomes FALSE again, the module responses by "OptionsSet_1=FALSE". So the module is ready for the next setting process.

Variable	Data type	Value	Explanation
Enable_Compare_1	BOOL	0	Deactivate compare function
		1	Activate compare function
SelectEncoder_1	BOOL	0	A, B, Ref with detection of direction
		1	Event counter at A B=0 down B=1 up
SetResolution_1	BOOL		Only if SelectEncoder=1 (Event counter)
		0	Rising and falling edges
		1	Only rising edges
ControlOutput_1	BOOL	0	Output_0_0 is a regular digital output
		1	Output_0_0 is controlled by the compare function.
OnErrorForceOutputsOff_1 (since release 3)	BOOL	0	In case of module error all digital and analog outputs are continued to update.
		1	In case of module error all digital and analog outputs are forced to 0.

4.21.3.3.2 Zähler 1 Kontrolle (Counter 1 Control)

Enabling and disabling of counting and referencing are determined by the state of the control variables.

Set and Reset functions are activated by setting of the appropriate variable.

The execution is indicated in the corresponding status variable.

If the control variable is reset, the counter module also resets the corresponding status variable.

Variable	Data type	Value	Explanation
SetOptions_1	BOOL	0/1	Take over "Zähler 1 Optionen"
ResetReferenced_1	BOOL	0/1	Reset of status bit "Referenced_1"
ResetCompared_1	BOOL	0/1	Reset of status bit "Compared_1"
ResetCaptured_1	BOOL	0/1	Reset of status bit "Captured_1"
EnableCounter_1	BOOL	0	Disable counter
		1	Enable counter
EnableReferencing_1	BOOL	0	Disable Referencing
		1	Enable Referencing
SetCounter_1	BOOL	0/1	Set counter to preset value
SetCompare_1	BOOL	0/1	Set compare value register
SetPreset_1	BOOL	0/1	Set preset value register
SetMax_1	BOOL	0/1	Set maximum value register

4.21.3.3.3 Zähler 1 Status (Counter 1 State)

The status variables indicate the status of the counter. This concerns

- the appearance of events and
- the indication of the execution of settings.

Variable	Data type	Explanation
Counting_1	BOOL	Counter is enabled
Referenced_1	BOOL	Reference function was executed Reset by ResetReferenced_1
Clockwise_1	BOOL	Counter counts up
Compared_1	BOOL	Compare function was executed Reset by ResetCompared_1
Captured_1	BOOL	Capture function was executed Reset by ResetCaptured_1
CounterSet_1	BOOL	Counter is set to preset value
CompareSet_1	BOOL	Compare value is set
PresetSet_1	BOOL	Preset value is set
MaxSet_1	BOOL	Maximum value is set
OptionsSet_1	BOOL	Options of counter 1 are set
OutputsOnErrorOff_1	BOOL	Outputs will be switched off in case of error (since release 3)

4.21.3.3.4 Zähler 1 Fehler (Counter 1 Errors)

The variables are provided for the indication of error states.

Variable	Data type	Explanation
OutputsForcedOff_1	BOOL	Outputs have been forced to 0 because of a module error (since version 3)
Err_Reserved_1_x	BOOL	reserved error bits

4.21.3.4 Counter values of Counter 1

4.21.3.4.1 Zähler 1 Sollwerte (Counter 1 Set Values)

The counter can be preset with different set values.

That is done by help of the variable "SetValue_1". After setting the following control bits the contents of "SetValue_1" will be copied in the corresponding register.

Variable	Explanation
SetCounter_1	Copy "SetValue_1" to the current counter value
SetCompare_1	Copy "SetValue_1" to the compare value register
SetPreset_1	Copy "SetValue_1" to the preset value register
SetMax_1	Copy "SetValue_1" to the maximum value register

The current set values can be read in the variable "SelectedValue" from the "Zähleristwerte" (Counter current values) group.

- Select by the variable "Select_1", which value you want to see in the variable "SelectedValue".

Variable	Data type	Explanation
Select_1	UINT	Selection which value of counter1 shall be displayed in the variable "SelectedValue":
		0 none
		1 Vergleichswert (Compare value)
		2 Vorwahlwert (Preset value)
		3 Endwert (Max value)
		4 Fangwert (Capture value)
		5 Counter pulses/second
		6 Revolutions per minute
		128 Version info
SetValue_1	DINT	Set value of counter 1 (source) to copy (operated by a control bit) into a set value register (target)

4.21.3.4.2 Zähler 1 Istwerte (Counter 1 Actual Values)

These variables display the current counter value and the current set values. The set values are represented multiplexedly in the variable "SelectedValue" (Selection by Select_1).

Variable	Data type	Explanation
Counter_1	DINT	Current value of counter 1
Selected_1	UINT	Selection of that value of counter 1, which is displayed in the variable SelectedValue. (Value of Select_1 read from the module)
		0 none
		1 Vergleichswert (Compare value)
		2 Vorwahlwert (Preset value)
		3 Endwert (Max value)
		4 Fangwert (Capture value)
		5 Counter pulses/second
		6 Revolutions per minute
		128 Version info
SelectedValue	DINT	Selected current value of counter 1

Version info:

Byte	3	2	1	0
Explanation	Version #	Release	Level	Type code
Example	0x2	0x00	0x00	0x53
	2	0	0	S

4.21.3.5 Digital I/Os

4.21.3.5.1 Zahler 1 Digitale Eingänge (Counter 1 Digital Inputs)

The variables indicate the status of the digital inputs.

Variable	Data type	Explanation
Input_0_0	BOOL	Digital Input 0
Input_0_1	BOOL	Digital Input 1
Input_0_2	BOOL	Digital Input 2
Input_0_3	BOOL	Digital Input 3
In_Output_0_0	BOOL	Status of Digital Output 0 (Reads the status)

4.21.3.5.2 Zähler 1 Eingangsflanken-Zeitstempel (Counter 1 Input Edge Timestamp)

The variables indicate the time, on which the status of the digital input has changed. When the time measurement is started, depends on the mode of operation.

(See also chapter 4.21.3.1 at page 105)

Variable	Data type	Explanation
Input_0_0_TS	UINT	Time stamp for Digital Input 0 (Hardware Trigger)
Input_0_1_TS	UINT	Time stamp for Digital Input 1 (Software Polling)
Input_0_2_TS	UINT	Time stamp for Digital Input 2 (Software Polling)
Input_0_3_TS	UINT	Time stamp for Digital Input 3 (Software Polling)



The time stamp is metered between frame- or DC-interrupts and signal changes on the input in μ s.

The value of the time stamp becomes to 0xFFFF, when no signal change takes place between two frame- or DC-interrupts.

in frame-synchronous mode:

The time from the last frame-interrupt to the status change of the input is stored in the time stamp and sent in the following frame to the EtherCAT master.

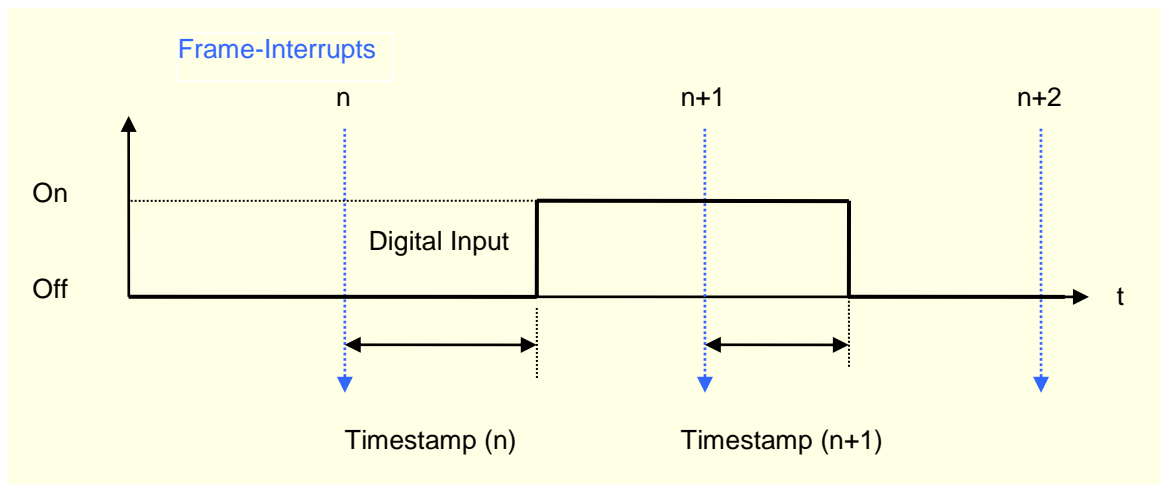

Frame	Digital Input	
	Variable	Timestamp
n+1	TRUE	Timestamp (n)
n+2	FALSE	Timestamp (n+1)

in DC-synchronous mode:

The time from the last DC-interrupt to the status change of the input is stored in the time stamp and sent in the following frame to the EtherCAT master.

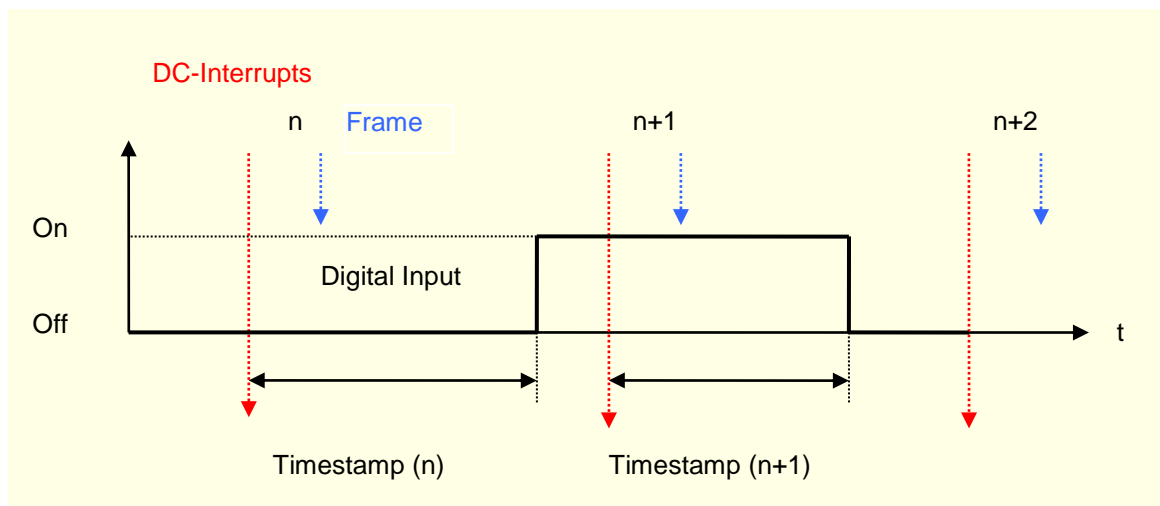

Frame	Digital Input	
	Variable	Timestamp
n+1	TRUE	Timestamp (n)
n+2	FALSE	Timestamp (n+1)

4.21.3.5.3 Digitale Ausgänge (Digital Outputs)

The variables indicate the status of the digital outputs.

Variable	Data type	Explanation
Output_0_0	BOOL	Digital Output 0 (Sets the output)

4.21.3.5.4 Ausgangsverzögerung (Output Set Delay) (in preparation)

This variable defines the time, when the output is set.

Variable	Data type	Explanation
Output_0_0_Del	UINT	Output set delay in μs

im Frame-synchronen Betrieb:

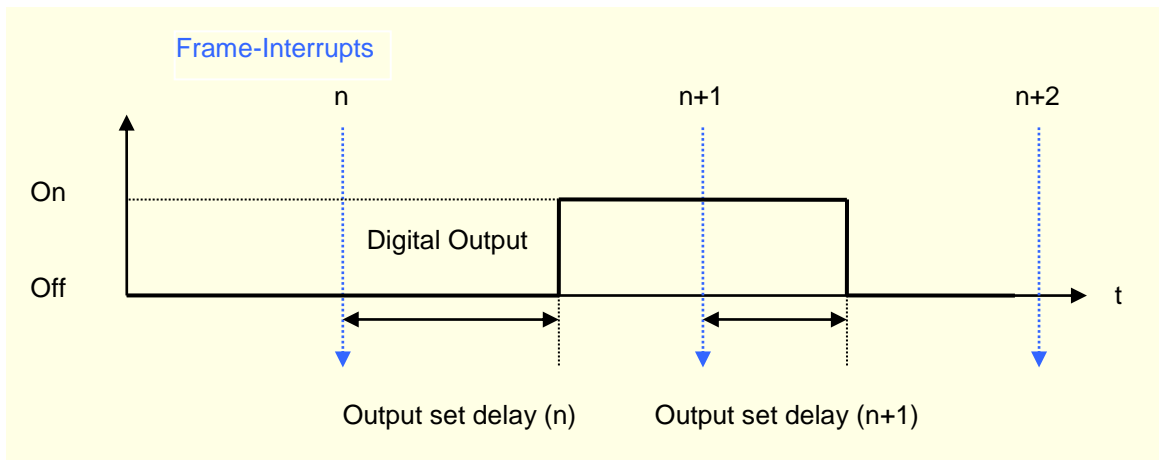

Frame	Digital Output	
	Variable	Output set delay
n	TRUE	Output set delay (n)
n+1	FALSE	Output set delay (n+1)

im DC-synchronen Betrieb:

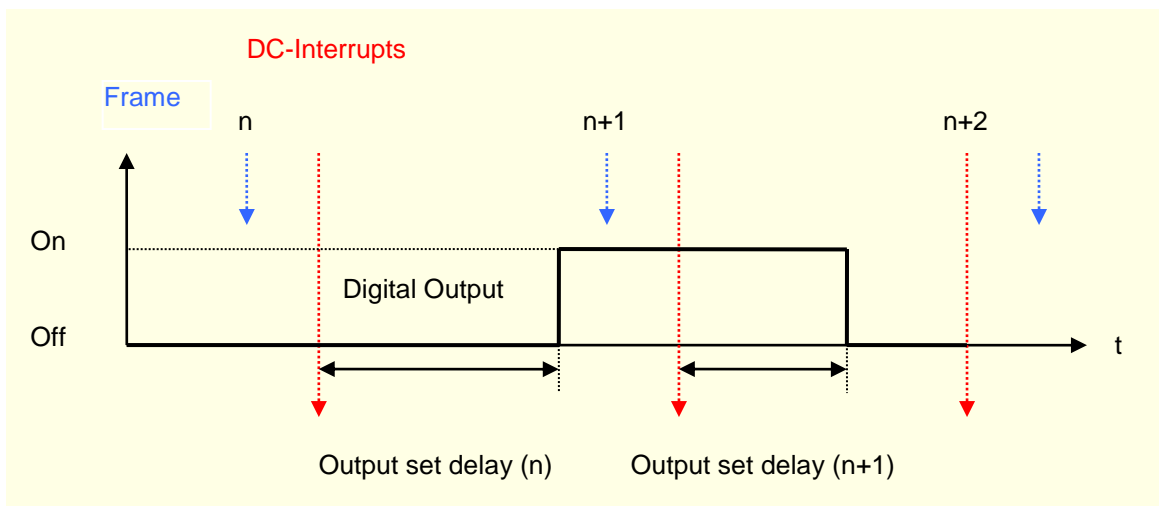

Frame	Digital Output	
	Variable	Output set delay
n	TRUE	Output set delay (n)
n+1	FALSE	Output set delay (n+1)

4.21.3.6 Analoge Ausgänge (Analog Outputs) (Counter/Posi2 5V only)

The variables define the Voltage of the analog outputs.

Variable	Data type	Explanation
AnalogOutput_1	UINT	Analog Output 1

Output values: See Figure 35: Analog values Voltage at chapter 51

4.21.4 Examples

4.21.4.1 Enable Counter

The counter is active, when the variable " EnableCounter_1" is TRUE.

Term2_EnableCounter_1:=TRUE;	(*Release of the counter*)
Term2_Counting_1;	(*TRUE, if counter is enabled*)
Term2_Clockwise_1;	(*Count direction, TRUE, when up*)

4.21.4.2 Counter Set/ Clear

Copying the contents of "SetValue_1" into the current value is executed by a rising edge to " SetCounter_1". Execution is indicated by "CounterSet_1=TRUE".

If "SetCounter_1" is reset (FALSE) again, "CounterSet_1" becomes also again FALSE.

Term2_SetValue_1:=diCounterValue ;	(*Copy a number into the source var*)
	(* 0 = Clear*) and
Term2_SetCounter_1:=TRUE;	(*copy to the counter current value*)
Term2_CounterSet_1;	(*TRUE, if set*)

4.21.4.3 Set Compare Value

Configuration settings set in "Zähler 1 Optionen" are activated by the rising edge of the control bit "SetOptions_1". The successful take-over of the options is confirmed with the status bit "OptionsSet_1".
e.g. Set compare function.

```
PROGRAM Initialization
VAR
    bInit: BOOL := TRUE;
    Step: USINT;
END_VAR
-----
IF bInit THEN
    CASE Step OF
        (*Select options, activate them by a rising edge to "Set_Options"*)
        0:   Term2_EnableCounter_1:=TRUE;   (*Release counter*)
            Term2_EnableCompare_1:=TRUE;   (*Activate compare function*)
            Term2_ControlOutput_1:=TRUE;   (*Compare function controls Output*)
            Term2_SetValue_1:=10000;       (*Set value = 10000..*)
            Term2_SetCompare_1:=TRUE;      (*..use as compare value*)
            Term2_SetOptions_1:=TRUE;      (*Activate selected options*)
            Step:= 1;
        (* Wait for confirmations "OptionsSet" and " CompareSet"*)
        1:   IF Term2_OptionsSet_1 AND Term2_CompareSet_1 THEN
                Step:= 2;
            END_IF
        (* Set "Set_Options" and " SetCompare" in the starting position*)
        2:   Term2_SetOptions_1:=FALSE;
            Term2_SetCompare_1:=FALSE;
```

```

        Step:=0;
        bInit:=FALSE;
    END_CASE
END_IF

```

4.21.4.4 Set Preset Value

Copying the value of "SetValue_1" into the preset value is executed by a rising edge to "SetPreset_1". The execution is indicated by "PresetSet_1=TRUE".

If "SetPreset_1" is reset (FALSE) again, "PresetSet_1" becomes also again FALSE.

```

Term2_SetValue_1:=diPresetValue ;    (*Copy a number into the source var*)
Term2_SetPreset_1:=TRUE;              (*Copy to the preset value*)
Term2_PresetSet_1;                    (*TRUE, if set*)

```

4.21.4.5 Set Maximum Value

Copying the value of "SetValue_1" into the preset value is executed by a rising edge to "SetMax_1". The execution is indicated by "MaxSet_1=TRUE".

If "SetMax_1" is reset (FALSE) again, "MaxSet_1" becomes also again FALSE.

```

Term2_SetValue_1:=diMaxValue ;    (*Copy a number into the source var*)
Term2_SetMax_1:=TRUE;              (*Copy to the maximum value *)
Term2_MaxSet_1;                    (*TRUE, if set*)

```

4.21.4.6 Digital Output

See also page 107: Zähler 1 Optionen (Counter 1 Options).

The digital output can be controlled optionally by the variable "Output_0_0" or the compare function. Decision is done by the variable "ControlOutput_1" (Set Options see also page 114)

The current status of the output is read from the module and displayed in "In_Output_0_0".

```

Term2_ControlOutput_1:=FALSE;      (*Term2_Output_0_0 controls output*)
Term2_ControlOutput_1:=TRUE;       (*Compare function controls output*)
Term2_In_Output_0_0;               (*Status of the output*)

```

4.21.4.7 Operating as A-B-Ref-Counter or Event Counter

(See also page 107: Zähler 1 Optionen (Counter 1 Options))

The counter can be operated as A, B, Ref -Counter with self detection of the direction or as event counter. The selection is done by the variable "SelectEncoder_1"

(Set Options see also page 114)

```
Term2_SelectEncoder_1:=FALSE;      (*A, B, Ref *)
Term2_SelectEncoder_1:=TRUE;       (*Event counter at A*)
                                   (*B=FALSE:down, B=TRUE:up*)
```

4.21.4.8 Single- und Multiple Counting

This option is valid in the event counter mode only.

(See also page 107: Zähler 1 Optionen (Counter 1 Options))

The counter can count edges (all rising and falling edges) or pulses (only the rising edges). The selection is done by the variable "SetResolution_1"

(Set Options see also page 114)

```
Term2_SetResolution_1:=FALSE;      (*all edges*)
Term2_SetResolution_1:=TRUE;       (*Pulses*)
```

4.21.4.9 Referencing

The counter can be set to preset value when a pulse occurs at the Ref input. The preset value can be 0, but also any other 32-bit number.

Task:

An encoder with 500 Pulses provides 2000 increments per turn in the all edges mode.

Every Ref pulse shall set the counter to the preset value 2000.

It shall be counted down to 0 within 1 turn.

(The counting direction is determined by the turning direction of the encoder.)

```
PROGRAM Referenzierung
```

```
VAR
```

```
    bInit: BOOL := TRUE;
```

```
    StepInit: USINT;
```

```
    bInitReady: BOOL;
```

```
    Step: USINT;
```

```
END_VAR
```

```

(*1. Initializing: Enabling of the counter and setting of the preset value*)
IF bInit THEN
    CASE StepInit OF
    (*Selecting of the options and setting them by a rising edge v. "Set_Options"*)
    0:   Term2_EnableCounter_1:=TRUE;
        Term2_SetValue_1:=2000;
        Term2_SetPreset_1:=TRUE;
        Term2_SetOptions_1:=TRUE;
        StepInit:=1;
    (* Wait for confirmations "OptionsSet" and "PresetSet"*)
    1:   IF Term2_OptionsSet_1 AND Term2_PresetSet_1 THEN
            StepInit:=2;
        END_IF
    (* Reset "Set_Options" und "Set_Preset" into the start position*)
    2:   Term2_SetOptions_1:=FALSE;
        Term2_SetPreset_1:=FALSE;
        StepInit:=0;
        bInit:=FALSE;
        bInitReady:=TRUE;
    END_CASE
END_IF

(*2. Controlling of the referencing*)
IF bInitReady THEN
    CASE Step OF
    (*Switch on the referencing mode*)
    0:   Term2_EnableReferencing_1:=TRUE;
        Step:=1;
    (* Wait for a referencing pulse*)
    1:   IF Term2_Referenced_1 THEN
            Step:=2;
        END_IF
    (* Reset of the referencing message*)
    2:   Term2_ResetReferenced_1:=TRUE;
        Step:=3;
    3:   IF NOT Term2_Referenced_1 THEN
        (* Reset "ResetReferenced_1" into the start position *)
            Term2_ResetReferenced_1:=FALSE;
        (*Switch on the referencing mode *)
            Term2_EnableReferencing_1:=FALSE;
            Step:=0; (*Next turn the same procedure.*)
        END_IF
    END_CASE
END_IF

```

4.21.4.10 Capture

A falling edge at the Digital Input 1 can be used as trigger in order to save the current counter value (capture).

You get a message in the status bit "Captured_1" that a capture event has appeared.

You have to reset "Captured_1" by "ResetCaptured_1" that the next capture event can be indicated.

Term2_Input_0_1;	(*Status of Input 1*)
Term2_Select_1:=4;	(*Copy capture register to Term2_SelectedValue_1*)
Term2_Selected_1;	(* =4, if capture value in Term2_SelectedValue_1*)
Term2_SelectedValue_1;	(*Here you can read the capture value*)
Term2_Captured_1;	(*A capture event has appeared *)
Term2_ResetCaptured_1;	(*Reset of Term2_Captured_1*)

4.21.4.11 Digital Inputs (Input_0_x)

The status of the digital inputs is indicated in the variables "Input_0_x".

Permanente additional function:

The current counter value is saved in the capture register when a falling edge appears at Input_0_1.

Term2_Input_0_0;	(*Status of Input 0*)
Term2_Input_0_1;	(*Status of Input 1*)
Term2_Input_0_2;	(*Status of Input 2*)
Term2_Input_0_3;	(*Status of Input 3*)

4.21.4.12 Analog Outputs (Counter/Posi2 5V only)

The output values of the analog outputs are written into the variables "AnalogOutput_x".

Term2_AnalogOutput_1:= 16#7FFF;	(* Set AnalogOutput_1 to +10V *)
Term2_AnalogOutput_2:= 16#8000;	(* Set AnalogOutput_2 to -10V *)

Output values : See Figure 35: Analog values Voltage at page 51.

4.21.5 Technical Data

Counter2 5V

Encoder2 A, B, Ref
 Encoder typeRS422, 5V, 24VDC
 Count rate.....RS422: 200kHz
24V: 200kHz*
 * for >25kHz not used encoder signals must be connected to +5V
 Digital Inputs.....8
 Input delay.....1ms
 Signal levelOff: -3 ... 5V
On: 15V ... 30V (EN 61131-3, Typ1)
 Digital Outputs.....2
 max. Current.....2A per output
 Feldbus.....EtherCAT 100 Mbit/s
 EtherCAT-DateiKuhnkeCounterPosiModul.xml
 WxHxD25x120x90 mm
 Montage35mm DIN-Hutschiene
 ControllerASIC ET1200
 E-Bus port10-pin system plug in side wall
 Term.modulenot required
 E-Bus-Load300mA
 Power supply:
 Logic.....by EtherCAT-Coupler via E-Bus-plug
 Connector IO/Power.....Plug 36-pole (not part of the module)
 Power24V DC -20% +25%
 Galvanic separationSeparated from one another and versus the bus
 Storage temperature-25 °C...+70 °C
 Operating temperature0°C...+55°C
 Relative humidity5%...95% without dewing
 ProtectionIP20
 Interference immunity.....Zone B
 part no.694.444.01

Counter/Posi2 5V

additional

Analog Outputs.....2
 Voltage-10V ...+10V
 Resolution12 bit
 part no.694.454.01

4.22 Extender 2 Port

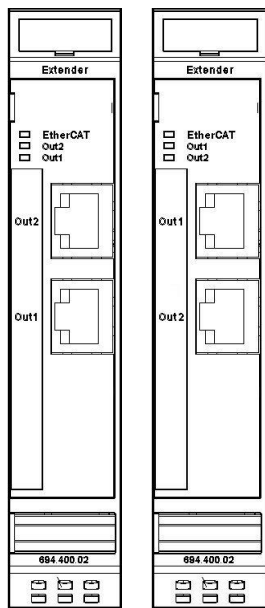

The purpose of the Ventura FIO Extender is the extension of a Ventura FIO block or a Ventura Skaleo (Embedded PC) by an EtherCAT slave, which has a standard 100 base TX connection.

The Extender module changes the transmitting physics of LVDS (E bus) on Twisted pair.

The module is usually arranged thereby at the end of the block. In addition, the Extender can be used in arbitrary place behind the bus coupler and/or the Skaleo controller module.

Thus EtherCAT Slaves can also be connected in star topology.

Figure 57:
Extender 2 Port Revision 2

Figure 58:
Extender 2 Port Revision 1

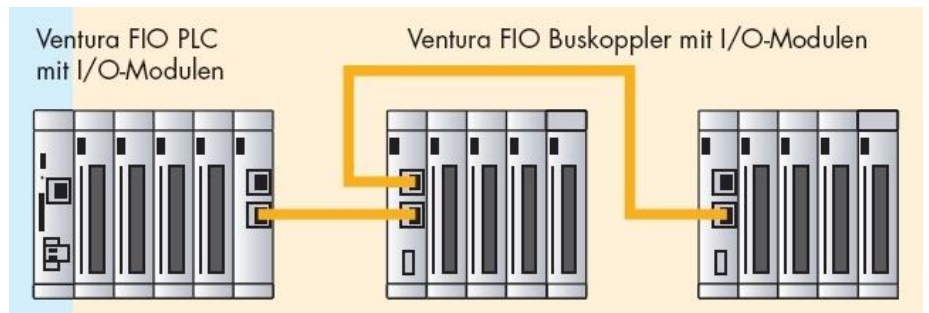

Figure 59: Ventura Skaleo, extended by Ventura FIOs



An incompatible change of the ports took place in July 2012. The review indicated by the location of OUT1 and OUT2. Revision 2 is marked on the side panel of the module with "Revision 2".

Always use the appropriate XML file to review for the EtherCAT configuration.

4.22.1 Terminals

Supply of the module:
via E-Bus

EtherCAT:

OUT1	RJ45-Socket	Output port (to the next EtherCAT-device)
OUT2	RJ45-Socket	Output port (to the next EtherCAT-device)

4.22.2 Status LEDs

4.22.2.1 "EtherCAT" LED

4.22.2.2 The LED labeled "EtherCAT" indicates the state of the EtherCAT ASIC.

State	LED flash code	Explanation
Init	Red, on	Initialization, no data exchange
Pre-Op	Red/green, 1:1	Pre-operational, no data exchange
Safe-Op	Red/green, 5:1	Safe operation, inputs readable
Op	Green, on	Operational, unrestricted data exchange

4.22.2.3 "In" LED, "Out" LED

The "Out2" and "Out1" LEDs indicate the physical state of the Ethernet ports they are allocated to.

State	LED flash code	Explanation
Not connected	Off	No Ethernet connection
Connected	Green, on	Connected to Ethernet
Traffic	Green, flashing	Exchanging telegrams

4.22.3 Function

The Extender 2 port module has actually 4 ports. Name 2 port module was chosen because of the 2 standard 100 base TX (OUT1, OUT2) RJ45 connections. Another 2 ports are covered by the E-bus.

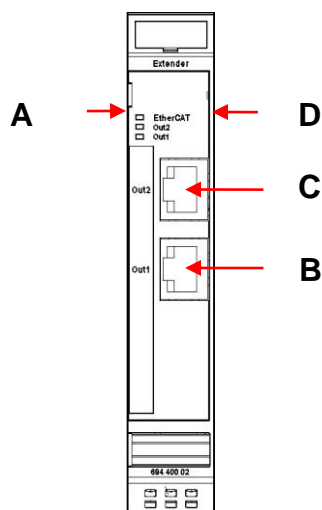

It is important to the configuration in which sequence the connections are operated, i.e. which way the EtherCAT frame runs.

Revision 1:

Port	Connection	sequence
Port A	E-Bus In	1
Port B	Out 1	3
Port C	Out 2	4
Port D	E-Bus Out	2

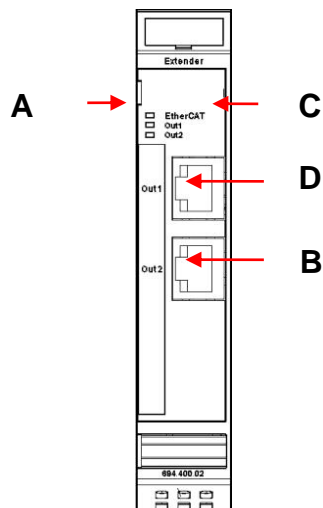

Revision 2:

Port	Connection	sequence
Port A	E-Bus In	1
Port B	Out 2	3
Port C	E-Bus Out	4
Port D	Out 1	2

4.22.4 Configuration example

For the following arrangement and wiring of modules the configuration is to be provided:

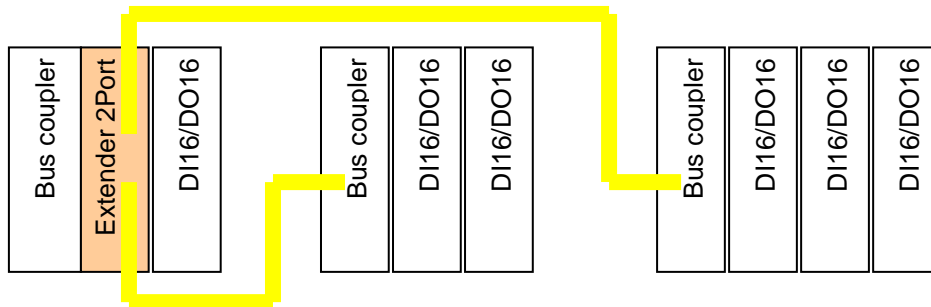

In the following example, revision 1 is used.

With revision 2, corresponds exactly to the representation of the topology and requires no further explanations.

4.22.4.1 Online Configuration

You get the following configuration in result of a bus scan by the EtherCAT-Configurator:

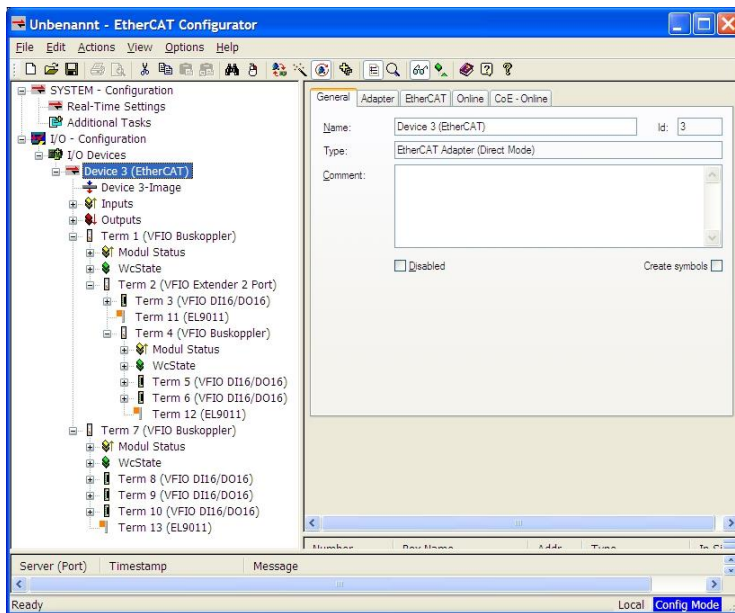

With bus scan the EtherCAT Configurator inserts end modules EL9001 automatically. That is a characteristic of the Configurator.

End modules are not necessary for Kuhnke modules and can be deleted unhesitatingly.

The device tree in the configurator does not support the representation of 3 branches below the Buskoppler Term1. The representation has to be interpreted as follows:

Directly behind the Extender module follow the devices at Port D (Term 3).

Then follow the devices at Port B (Term 4 with Term 5 and Term 6).

Then follow the devices at Port C (Term 7 with Term 8, Term 9 and Term 10)



Ventura INtime EC2:

Consider the numbering Term x. They become the prefix of the variable names in CoDeSys. Also end modules occupy a number.

4.22.4.2 Offline Configuration

- File, New leads to a new I/O Configuration.
- Highlight "I/O Devices" and operate "Append Devices". So you insert "Device 1 (EtherCAT)" that corresponds to an EtherCAT-line.
- Highlight then "Device 1 (EtherCAT)" and operate "Append Box".
- Expand the view to the group of Kuhnke (and possibly still another subgroup) and select then "Bus coupler (694.400.00)".

- Highlight then "Term 1 (Ventura FIO Buskoppler)" and operate "Append Box".
- Expand the view to the group of "Kuhnke Automation GmbH & Co KG" and the sub-group "Communication modules" and select then "Extender 2 Port (694.400.02)".

At the right side Port B is preselected. That means the connection to Port B of Term 1 (E-Bus-Port of the Bus coupler).

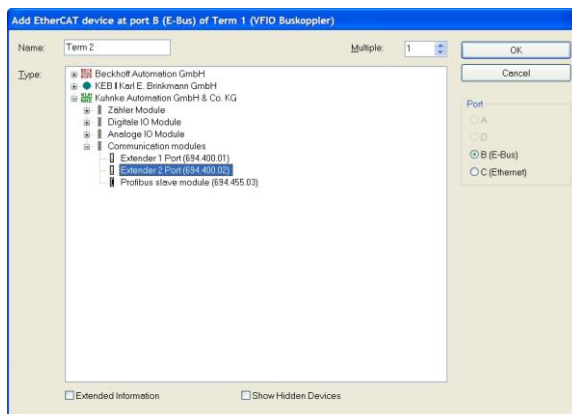

- Operate "Append Box" and select "DI16/DO16 (694.450.01)". At the right side Port D is preselected. That means the connection to Port D of the extender module.

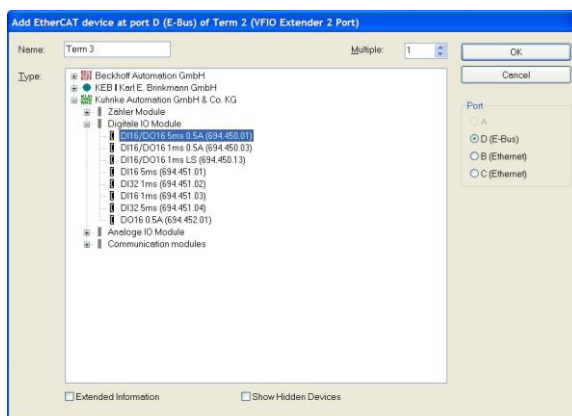

- Highlight "Term 2 (VFIO Extender 2 Port)" in the device tree and operate "Append Box". Select "Buskoppler (694.400.00)" and change the choice at the right side to B (Ethernet). That means the connection to Port B of Term 2, i.e. Out1.

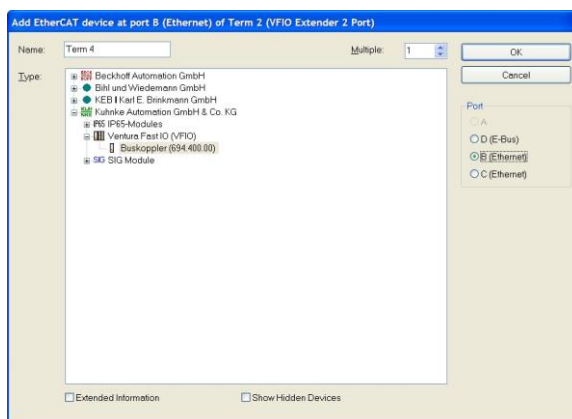

- Operate "Append Box", select "DI16/DO16 (694.450.01)" and set Multiple to 2.

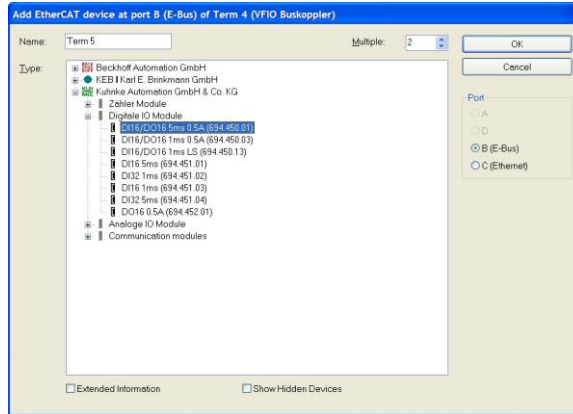

- Highlight "Term 2 (VFIO Extender 2 Port)" in the device tree, again and operate "Append Box". Select "Buskoppler (694.400.00)" and change the choice at the right side to C (Ethernet). That means the connection to Port C of Term 2, i.e. Out2.

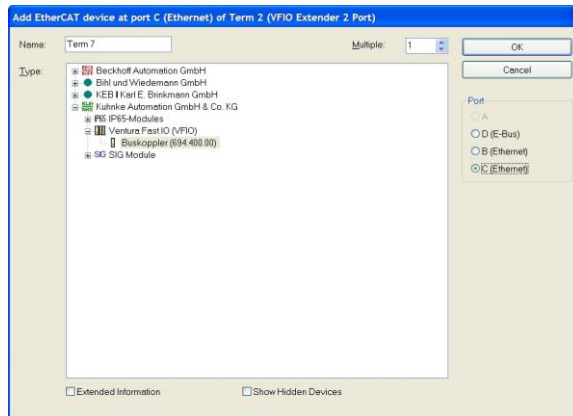

- Operate "Append Box", select "DI16/DO16 (694.450.01)" and set Multiple to 3. Thus the configuration is complete.

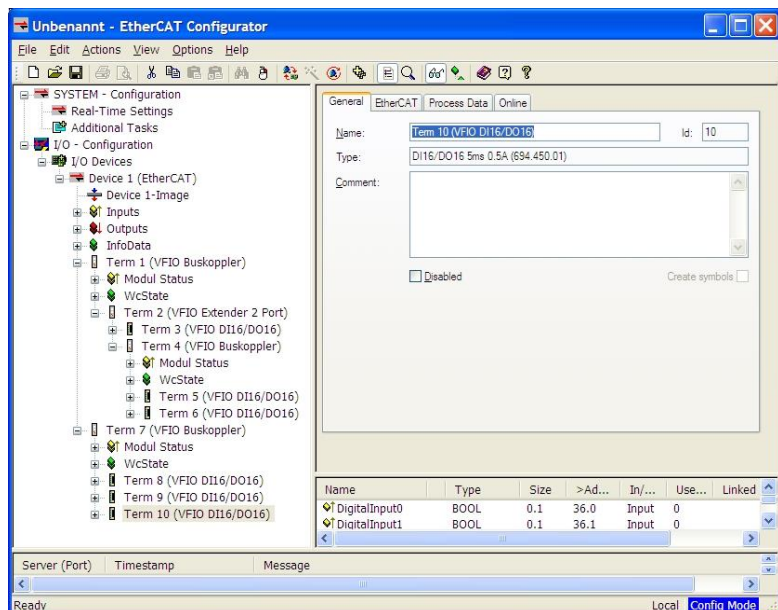

4.22.5 Technical Data

Function.....	Extension of a Ventura FIO block resp. a Ventura Skaleo (Embedded PC). Transformation of transmission physics from LVDS (E-Bus) to 100Base-TX.
EtherCAT-file Rev1	KuhnkeEtherCATModules.xml
EtherCAT-file Rev2	KuhnkeExtender2PortRevision2.xml
Controller.....	ASIC ET1100
Baudrate.....	100Mbit/s
Cable	CAT5
Cable length	max. 100m
EtherCAT Connection	2 x RJ45
Power supply.....	via E-Bus
E-Bus-Load	160mA for Out1 / 210 mA for Out1+Out2
Part no	694.400.02

4.23 MIX 02

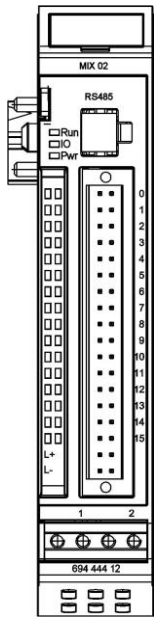

Figure 61: Front view I/O-module MIX 02

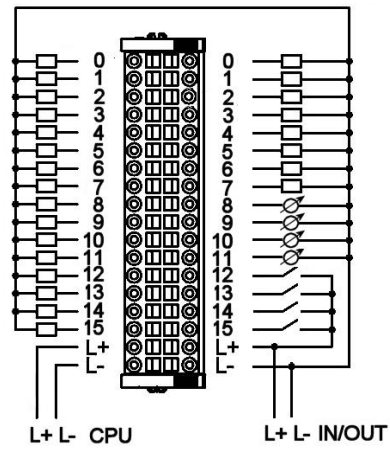

Figure 60: Pinning MIX 02

4.23.1 Terminals

4.23.1.1 IO-Terminal 36-pole, male

Side	Pin	Signal	Meaning		
left	0..15	DO8..DO23	Digital Outputs 8..23		
	16, 17	+24VDC, 0V	Module supply CPU		
right	0..7	DO0..DO7	Digital Outputs 1..7		
	8..11	AI0..AI3, DI0..DI3	Analog Inputs (Use as DI, too)		
	12	DI4	Digital Input DI		
	13	DI5	C_Clock	DI Counter clock input (rising edge)	
	14	DI6	C_Dir	DI Counter Direc- tion	FALSE: up TRUE: down
	15	DI7	C_Clear	DI Counter Clear (rising edge)	
	16, 17	+24VDC, 0V	IO-supply		

Operative earth / shielding of analog and clock wires → chapter 3.1.1

4.23.1.2 RS484-port

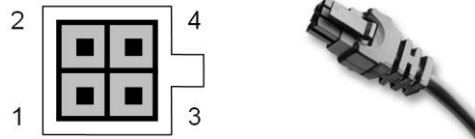

Figure 62: Molex Micro Fit 4-pole male

Pin	Signal	Explanation
1	DGND	Data ground potential (reference to TxD/RxD)
2	GND	Ground potential
3	RxD/TxD-P	Data+
4	RxD/TxD-N	Data-

4.23.2 Status LED

4.23.2.1 LED "Run"

The LED labeled "Run" indicates the state of the EtherCAT-ASICs.

State	LED flash code	Explanation
Init	Off	Initialization, no data exchange
Pre-Op	Off/green, 1:1	Pre-operational, no data exchange
Safe-Op	Off/green, 5:1	Safe operation, inputs readable
Op	Green, on	Operational, unrestricted data exchange

4.23.2.2 LED "IO"

The LED labeled "IO"-LED indicates the state of the module's I/Os.

State	LED flash code	Explanation
Ok	Green, on	No error
Error	Red, flashlight	Connection error
Start, Defect	Red	Module is not initialised

4.23.2.3 LED "Pwr"

The LED labeled "Pwr" indicates the state of the I/O-supply of the module.

State	LED flash code	Explanation
On	Green, on	24 VDC supply ok
Off	Off	24 VDC supply not ok

4.23.2.4 LEDs "Channel"

The channel-LEDs indicate the state of the associated In-/Output-Signals.

State	LED flash code	Explanation
On	Green, on	Input signal TRUE / Output switched on.
Off	Off	Input signal FALSE / Output switched off.

4.23.3 Function (CoE-variant)

The module has 4 MIX 02 interruptible digital inputs (can be used as a counter), 4 analog inputs (can be used as digital inputs) and 24 digital outputs. Access to the IOs and the module status takes place via Process Data Objects, which are reflected in the control program of the EtherCAT master in variables.

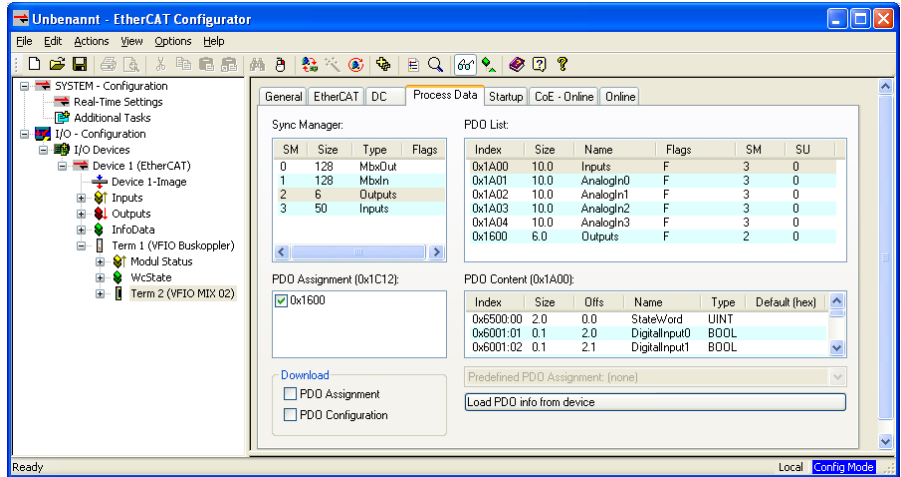

Service Data Objects are created for settings and information.

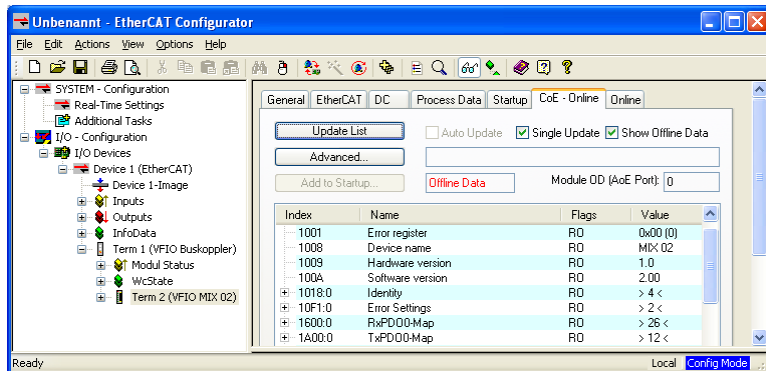

Settings for the MIX 02 module, for example, the RS485 baud rate, can be already made in the offline configurator. These are then executed by the EtherCAT master at startup.

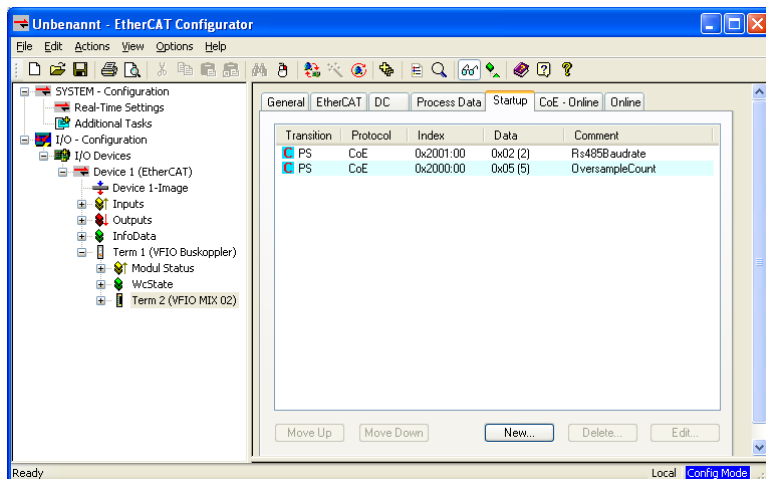

With the SDO transfer blocks available for the EtherCAT master is it possible to make settings at run time and to transfer data via the RS485.

4.23.3.1 Inputs

In the Inputs group, see the following input values:

Variable	Data type	Meaning	
StateWord	UINT	Status word	
		Bit0	RS485 Receive data available
		Bit1	RS485 Receive data overflow
		Bit2	Short circuit (overload) outputs
		Bit3	Undervoltage CPU
		Bit4	Undervoltage In/Out (Load)
		Bit5	EtherCAT Watchdog error
Bit6..15	unused		
DigitalInput0	BOOL	Digital Input0	
DigitalInput1	BOOL	Digital Input1	
DigitalInput2	BOOL	Digital Input2	
DigitalInput3	BOOL	Digital Input3	
DigitalInput4	BOOL	Digital Input4	
DigitalInput5	BOOL	Digital Input5	
DigitalInput6	BOOL	Digital Input6	
DigitalInput7	BOOL	Digital Input7	
Counter	UDINT	Value of the event counter associated to DI5..7	
SampleCycleCounter	UINT	is incremented, when new analog values are present	

4.23.3.2 AnalogIn0

In the AnalogIn0 group, see the following input values:

Variable	Data type	Meaning
AnalogIn0_Sample0	UINT	Analog Input 0, Sample n
AnalogIn0_Sample1	UINT	Analog Input 0, Sample n+1
AnalogIn0_Sample2	UINT	Analog Input 0, Sample n+2
AnalogIn0_Sample3	UINT	Analog Input 0, Sample n+3
AnalogIn0_Sample4	UINT	Analog Input 0, Sample n+4

4.23.3.3 AnalogIn1

In the AnalogIn1 group, see the following input values:

Variable	Data type	Meaning
AnalogIn1_Sample0	UINT	Analog Input 1, Sample n
AnalogIn1_Sample1	UINT	Analog Input 1, Sample n+1
AnalogIn1_Sample2	UINT	Analog Input 1, Sample n+2
AnalogIn1_Sample3	UINT	Analog Input 1, Sample n+3
AnalogIn1_Sample4	UINT	Analog Input 1, Sample n+4

4.23.3.4 AnalogIn2

In the AnalogIn2 group, see the following input values:

Variable	Data type	Meaning
AnalogIn2_Sample0	UINT	Analog Input 2, Sample n
AnalogIn2_Sample1	UINT	Analog Input 2, Sample n+1
AnalogIn2_Sample2	UINT	Analog Input 2, Sample n+2
AnalogIn2_Sample3	UINT	Analog Input 2, Sample n+3
AnalogIn2_Sample4	UINT	Analog Input 2, Sample n+4

4.23.3.5 AnalogIn3

In the AnalogIn3 group, see the following input values:

Variable	Data type	Meaning
AnalogIn3_Sample0	UINT	Analog Input 3, Sample n
AnalogIn3_Sample1	UINT	Analog Input 3, Sample n+1
AnalogIn3_Sample2	UINT	Analog Input 3, Sample n+2
AnalogIn3_Sample3	UINT	Analog Input 3, Sample n+3
AnalogIn3_Sample4	UINT	Analog Input 3, Sample n+4

4.23.3.6 Outputs

In the Output group, see the following output values:

Variable	Data type	Meaning
ControlWord	UINT	Bit 0 Error message Reset
		Bit 1 Counter Reset (Function by 0->1 edge)
		Bit 2..15 unused
DigitalOutput0	BOOL	Digital Output 0
DigitalOutput1	BOOL	Digital Output 1
DigitalOutput2	BOOL	Digital Output 2
DigitalOutput3	BOOL	Digital Output 3
DigitalOutput4	BOOL	Digital Output 4
DigitalOutput5	BOOL	Digital Output 5
DigitalOutput6	BOOL	Digital Output 6
DigitalOutput7	BOOL	Digital Output 7
DigitalOutput8	BOOL	Digital Output 8
DigitalOutput9	BOOL	Digital Output 9
DigitalOutput10	BOOL	Digital Output 10
DigitalOutput11	BOOL	Digital Output 11
DigitalOutput12	BOOL	Digital Output 12
DigitalOutput13	BOOL	Digital Output 13
DigitalOutput14	BOOL	Digital Output 14
DigitalOutput15	BOOL	Digital Output 15
DigitalOutput16	BOOL	Digital Output 16
DigitalOutput17	BOOL	Digital Output 17
DigitalOutput18	BOOL	Digital Output 18
DigitalOutput19	BOOL	Digital Output 19
DigitalOutput20	BOOL	Digital Output 20
DigitalOutput21	BOOL	Digital Output 21

DigitalOutput22	BOOL	Digital Output 22
DigitalOutput23	BOOL	Digital Output 23
DigitalOutput24	BOOL	Digital Output 24

4.23.3.7 Object directory

Index	Name	Typ	Default	Min Max	Access
1000	Device Typ	UINT32	0xF0191		RO
1008	Device Name	String	MIX 02		RO
1009	Hardware Version	String	1.0		RO
100A	Software Version	String	2.00		RO
1018	Identity Object	Array			
1018, 1	Vendor Id	UINT32	0x0048554B		RO
1018, 2	Product Code	UINT32	177173		RO
1018, 3	Revision Number	UINT32	2		RO
1018, 4	Serial Number	UINT32	0		RO
2000	OversamplingCount	UINT8	5	1,5	RW
2001	Rs485Baudrate	UINT8	2	0,9	RW
2002	Rs485Data	Octet-String 10			RW
6000	Counter	UINT32			RO P
6001	Digital Inputs	Array			
6001, 1..8	DigitalIn0..7	BOOL			RO P
6010	SampleCycleCounter	UINT16			RO P
6401	AnalogIn0	Array			
6401, 1..5	Sample0..4	UINT16			RO P
6402	AnalogIn1	Array			
6402, 1	Sample0	UINT16			RO P
6402, 2	Sample1	UINT16			RO P
6402, 3	Sample2	UINT16			RO P
6402, 4	Sample3	UINT16			RO P
6402, 5	Sample4	UINT16			RO P
6403	AnalogIn2	Array			
6403, 1..5	Sample0..5	UINT16			RO P
6404	AnalogIn3	Array			
6404, 1..5	Sample0..5	UINT16			RO P
6500	StateWord	UINT16			RO P
7000	DigitalOutputs	Array			
7000, 1..24	DigitalOut0..23	BOOL			RW P
7001	ControlWord	UINT16			RW P

RO=Read only, RW= Read/Write, P=Process image

4.23.3.8 Analog Inputs / Oversampling

The samples of the analog inputs are cyclically determined on the module and provided in variables for pickup by the EtherCAT master. For the evaluation of an analog value pattern both the cycle time of the analog conversions and the EtherCAT cycle play a role.

For an accurate assessment the module provides oversampling with adjustable parameters. There are two methods of control that can be selected already in the configurator.

SM-Synchronous (SM=Sync-Master)

DC-Synchronous (DC=Distributed Clocks)

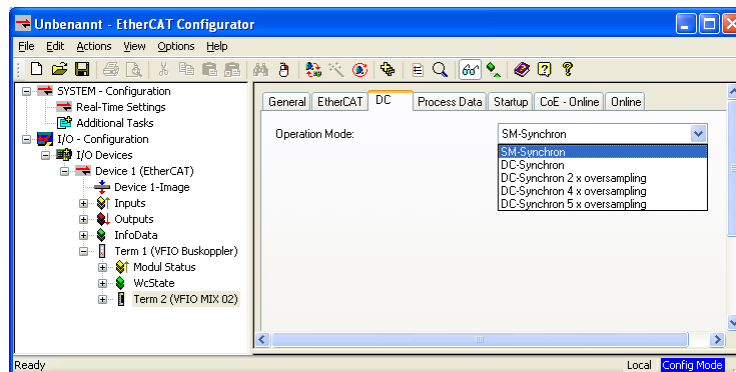

4.23.3.8.1 Analog Inputs / Oversampling SM-Synchron

The module measures every millisecond 4 analog values. Depending on the setting of the oversampling parameter (object index 0x2000) these values are copied into the process image. The default is 5.

In this setting, the analog process image will be updated after 5ms (indicated by the incremented counter *Inputs, Sample Cycle Counter*).

The millisecondly measured values are respectively in *Sample0..4* of the variables from *AnalogIn0 .. AnalogIn4*.

If the parameter is smaller, the process image is updated accordingly faster and the unused sample values remain empty.

Example:

If the oversampling parameter is 1, a new process image is generated after 1 millisecond.

The values are then only on *Sample0*. *Sample 1..4* are unused.

4.23.3.8.2 Oversampling DC-Synchron

The SYNC0 interrupt is used for analog measurement and the SYNC1 Interrupt for transmitting the data to the process image.

SYNC0 may be faster by a factor of 1 to 5 than SYNC1.

Example1:

Bus Cycle is 5ms. "DC synchron 5 x oversampling" is set.

This Sync1 is triggered every 5ms and SYNC0 all 1ms.

The analog values are therefore measured every millisecond and copied after 5ms to the process image in *Sample 0-4*. The *SampleCycleCounter* is incremented after 5ms.

Example2:

Bus Cycle is 2ms. "DC synchron 4 x oversampling" is set.

This Sync1 is triggered every 2ms and SYNC0 all 0.5ms.

The analog values are therefore measured every half millisecond and copied after 2ms to the process image in *Sample 0-3*. *Sample 4* remains empty. The *SampleCycleCounter* is incremented after 2ms.

Beispiel3:

Bus Cycle is 1ms. "DC synchron"

The Sync0 is triggered every 1ms.

The analog values are therefore measured every millisecond and copied to the process image in *Sample 0*. *Sample 1-4* remain empty.

The *SampleCycleCounter* is incremented after 2ms.

4.23.3.9 Rs485

Value	Baud rate
0	2400
1	4800
2 (default)	9600
3	19200
4	38400
5	57600
6	115200
7	230400
8	460800
9	921600

The Baud rate of the RS485 is set via Object 0x2001.

Data are sent and received via object 0x2002.

Byte	Meaning
0	Number of Data
1	-
2	Data Byte 0
...	...
9	Data Byte 7

If the object is written [number of data] from the data bytes 0..7 are sent.

If the object is read a maximum of 8 data bytes will be removed from the receive queue.

Is [number of data] = 0, so nothing was received.

The SDO transfer to and from the object is always 10 bytes long.

Bit0 in the *StateWord* indicates that data are in receive queue.

The receive buffer contains a maximum of 1024 bytes. An overflow is indicated by Bit1 in the *StateWord*.

4.23.3.10 Counter

Parallel to the use as digital inputs, the inputs DI5..7 are evaluated for an event counter.

The counter value *Inputs, Counter* is a 32 bit value.

- The clock signal to count is connected to DI5.
- The counting direction is determined by the state of DI6.
If DI6 = FALSE each rising edge at DI5 leads for incrementing of *Inputs, Counter*.
If DI6 = TRUE, each rising edge at DI5 executes the decrementing of input data, position counter.
- Rising edge at DI7 sets *Inputs, Counter* to the value 0.

The counter value can be reset by software (rising edge at *Outputs, ControlWord, Bit 1*).

4.23.3.11 Analog Inputs / Oversampling

The analog conversions occur cyclically every 1ms and asynchronously to the arrival of EtherCAT telegrams. The module offers oversampling.

Depending on the setting of the oversampling parameter, the measured values are copied in the process image. The default is 5:

In this setting, the analog values are renewed in the process image as a consistent set (indicated by the incremented counter in the *StateWord*) only after 5ms. The interval of 1ms measured values are then in the variables *AnalogInx_Sample0..4*. ($x = 0..3$)

If the oversampling parameter is smaller, the process image is updated accordingly faster and the unused sample values remain empty.

If the oversampling parameter is 1, a new process image is generated after 1 millisecond.

The values are then only on Sample0. Sample 1..4 are unused.

Timeliness of analog values in the EtherCAT master:



Look at the EtherCAT cycle for the assessment of the timeliness of the measured values in the EtherCAT master. From the perspective of this module would be 1..5ms ideal EtherCAT cycle settings.

Consistency of analog values:



The module delivers consistent sets of analog values. Note that you must evaluate the sample values in the Master consistent.

Quality of analog values:



You will get the best results if you apply the shield of the signal cable to the ground terminal.

4.23.3.12 Undervoltage

When undervoltage CPU or undervoltage load occurs the outputs are switched off, the bits 3 and 4 in *Inputs, StateWord* are set and the module IO LED flashes (2x).

If the voltage is again within the permissible range (24V -20% .. +25%), the error state can be reset by *Outputs, Control Word Bit 0*. Then, the outputs are turned on again.

4.23.3.13 Short Circuit

The outputs are protected thermally at the output driver. If the permissible current is exceeded, the output concerned is switched off, Bits3 in *Inputs, StateWord* is set and the module IO LED flashes (1x).

If the short circuit is removed, the error state can be reset by *Outputs, ControlWord Bit 0*.

4.23.4 Technical Data

MIX 02		
Digital Inputs.....	4 (8)	
DI0..3.....	1ms	
DI4.....	0.1ms	
DI5..7.....	0.001ms	
Counter (DI5).....	500kHz (up to 1 MHz) ⁵	
Digital Outputs.....	24	DO0..7: 0.5A
		DO8..23: 0.1A
Analog Inputs	4 x 0..10V	
Resolution	12 Bit	
Sampling rate	1ms	
RS485	electrically isolated	
Baud rate.....	2.4...921.6 kBit/s	
Termination	e.g. 4 x KDT 621 (9.6 resp. 19.2 kBit/s)	
Connector IO/Power.....	Plug 36-pole (not part of the module)	
Controller.....	ASIC ET1200	
Baud rate.....	100 Mbit/s	
E-Bus port	10-pin system plug in side wall	
Term. module	not required	
Power supply.....	24V DC -20% +25%	
E-Bus-Load	90mA	
Part no.....	694 444 62 CoE-variant	

⁵ Value in brackets with ideal clock signal and ground

5 Supplement

5.1 Potential Distributor 2 x 16

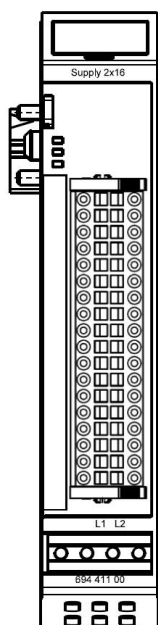

Figure 64: Front view of AI-TE I/O-module

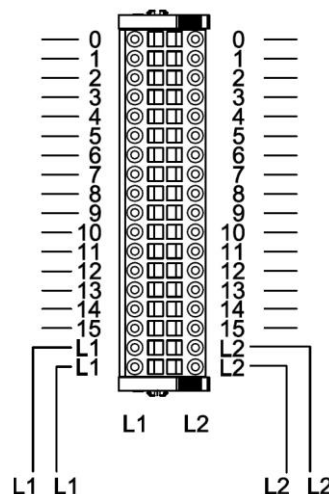

Figure 63: Connections

5.1.1 Terminals

The module has 2 separate potential lines.

It distributes the potential (optional 0 VDC or 24 VDC) attached at the pins L1 or L2 on the pins 0 to 15 of the same row.

The E bus is passed on from the previous one to the next module.

5.1.2 Status LEDs

The module has no Status LEDs.

5.1.3 Function

2-wire or 3-wire potential distributor for digital IO-modules.

5.1.4 . Technical Data

Potential distributor 2 x 16

Connector Potential	Plug 36-pole (not part of the module)
E-bus port	10-pin system plug in side wall
E-bus load	no
Part no.	694.411.00

5.2 Shield connection terminal block

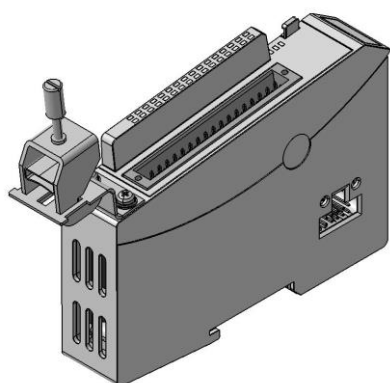
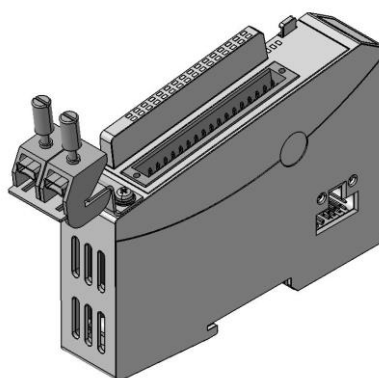

Figure 65:
1x14mm



Shield connection terminal block
2x8mm

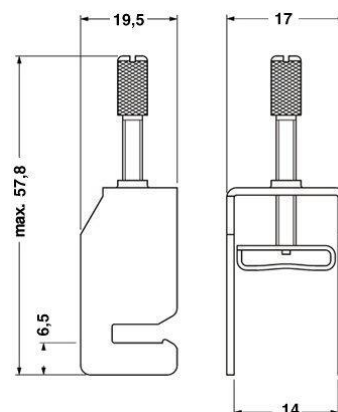

Figure 66:
Measurements of the clamp 14mm

5.2.1 Terminals



The shield connection terminal block consists of the shield clamp, the clamp holder, 2 screws M3x5, 2 washers and 2 spring washers.

Fasten the clamp holder by using the washers and spring washers on the housing of the Ventura FIO module.

Use the tapped holes on the front side. They are provided for it.

5.2.2 Function

The shield connection terminal block makes it easy to apply the cable shield directly to the Ventura FIO module.

The Shield connection terminal block conducts the potential of the cable screen on the DIN top hat rail on which the Ventura FIO module is picked up.



The mounting rail must have a suitable earth connection.



The Shield connection terminal may not be used as strain relief.

For earth see also chapter 3.1.1

5.2.3 . Technical Data

Shield connection terminal block 2x8mm

Shield clamp 8mm.....2 pieces

Part no.....694.412.01 154.008

Shield connection terminal block 14mm

Shield clamp 8mm.....1 piece

Part no.....694.412.02 154.009

6 Configuration

The EtherCAT master needs to be configured to drive the EtherCAT network.

One major part of the configuration is to specify the EtherCAT slave stations. There are two ways of documenting the properties of an EtherCAT slave.

1. The basic properties are stored in an EEPROM of the slave, whereas a XML device file describes the others.
2. All of the properties are stored in an EEPROM of the slave. (This method is not supported by every OEM supplier.)

The XML device files provide EtherCAT administrators with convenient options.

EtherCAT allows both, a configuration offline and the scanning of station data via an Ethernet line (online configuration).

The examples below are based around the standard ETG configuration tool (EtherCAT configuration tool supplied by Beckhoff Automation GmbH) which accesses the XML device files for both offline and online configuration.

The file to use for Ventura FIO is called "**KuhnkeEtherCATModules.xml**".

Copy file "KuhnkeEtherCATModules.xml" to folder C:\Programs\EtherCAT Configurator\EtherCAT or, if you are using another tool, to the folder set for that tool.

6.1 Offline configuration

- Run the EtherCAT configuration tool.
- Choose File, New to create a new I/O Configuration.
- Select "I/O Devices" and run "Append Devices". This will add "Device 1 (EtherCAT)" to your configuration, i.e. a new EtherCAT line.

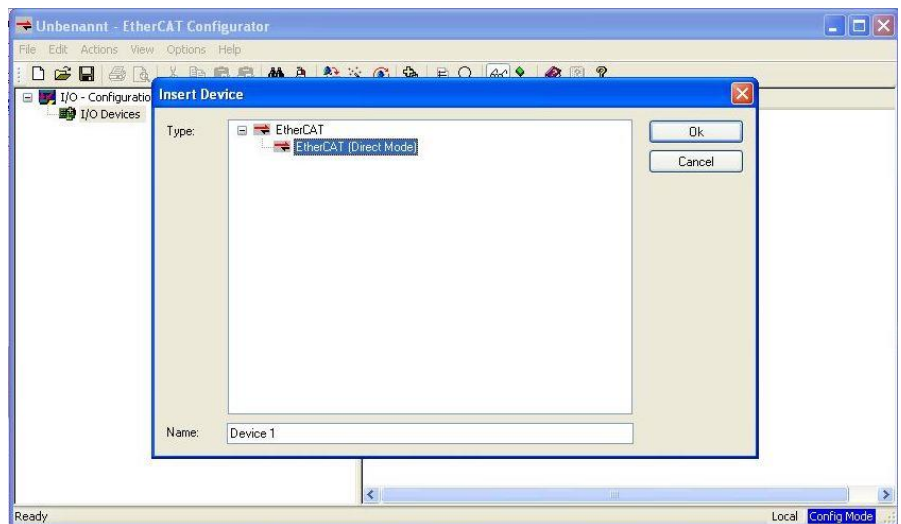

- Select "Device 1 (EtherCAT)" and run "Append Box".
- Expand the branch labeled "Kuhnke" and its sub-branch and select "Bus coupler (694.400.00)".

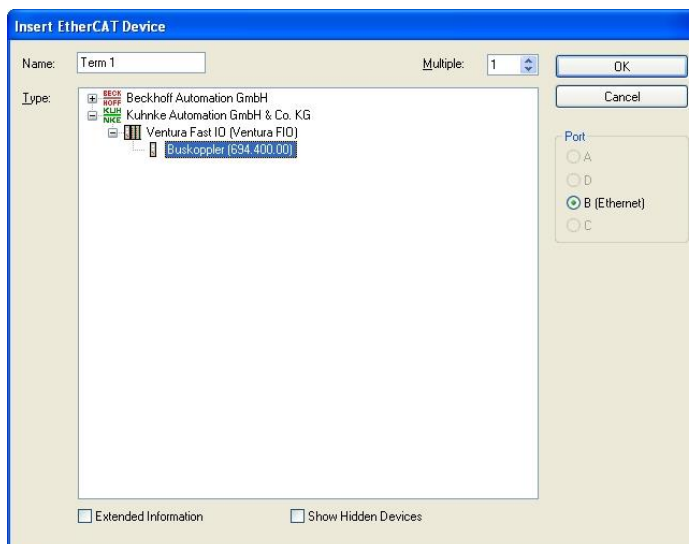

- The software suggests to call it "Term1". Change the name and add comments as appropriate.
- Select "Term 1 (Ventura FIO Bus Coupler)" and run "Append Box".
- Expand branch "Kuhnke Automation GmbH & Co KG" and its sub-branch "Digital IO Modules" and pick "DI16/DO16 (694.450.01)" from it.

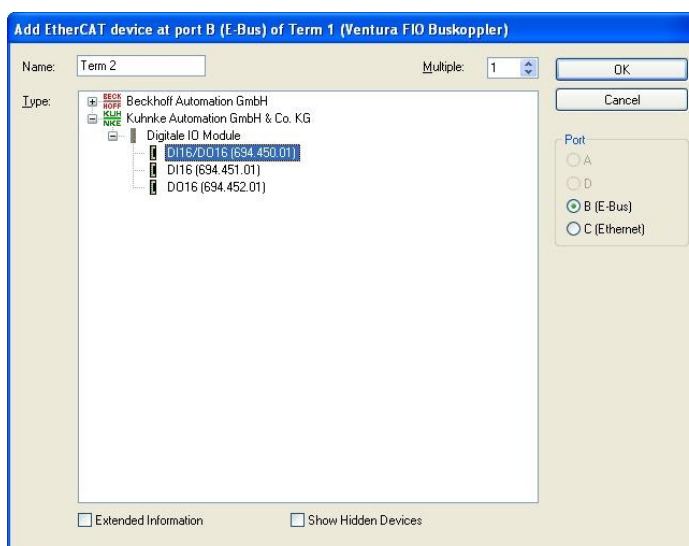

- Expand branch "Kuhnke Automation GmbH & Co KG" and its sub-branch "Digital IO Modules" and pick "DI16/DO16 (694.450.01)" from it.
- Keep repeating this step until your configuration is complete.

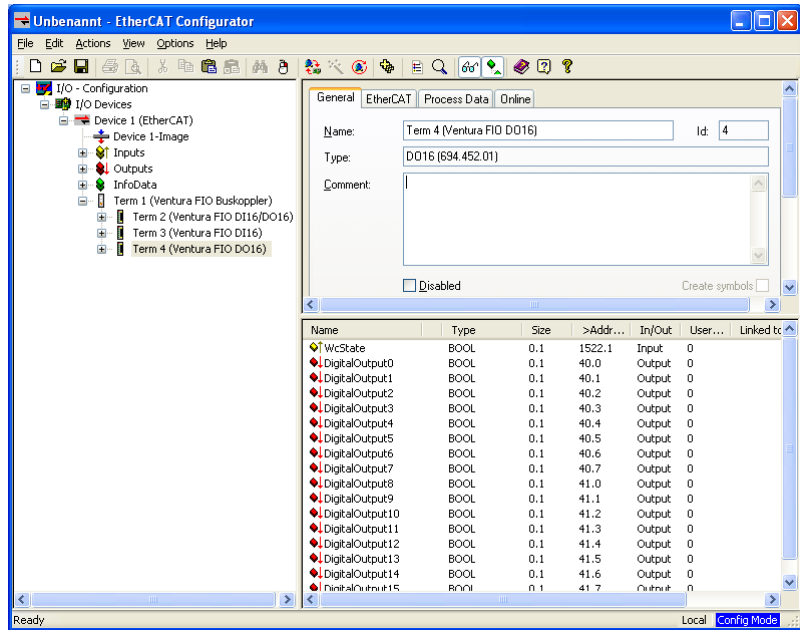

This completes the configuration required by the EtherCAT master which can be saved to an *.esm type of file. If you are setting up a project for a Ventura EtherCAT master, the file is called "KuECAT.esm".

If your PC is connected to the EtherCAT I/O module via the Ethernet, you can already run an online test of the Ventura FIO modules.

- Choose "Toggle Free Run State" (Ctrl+F5) to enable the "Operational Mode" of the EtherCAT I/O modules.
- Select the variable you wish to test. Read inputs and set outputs!



Set outputs only if you are sure that this will cause no harm.

6.2 Online configuration

EtherCAT allows you to scan the stations connected to an Ethernet line. The task of the example below is to retrieve the configuration of an I/O unit consisting of a Ventura FIO bus coupler and a module Ventura FIO DI16/DO16.

- Connect the Ventura FIO bus coupler with module Ventura FIO DI16/DO16 and turn on the power supply.
- Attach a CAT5 cable to the Ethernet port of your PC to connect it to the Ventura FIO bus coupler.
(You are free to attach either a patch cable or a cross cable.)
- Run the EtherCAT configuration tool.
- Choose File, New to create a new I/O Configuration.
- Select "I/O Devices" and run "Scan Devices". (Assuming your PC has several Ethernet ports you must first select the one that the EtherCAT line is attached to.)

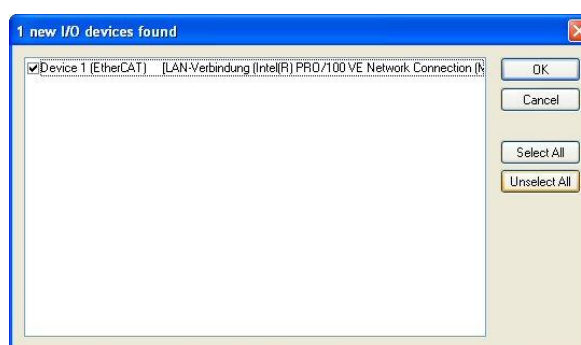

- Click on "Yes" to answer prompt "Scan for boxes?".
- This completes the configuration required by the EtherCAT master which can be saved to an *.esm type of file. If you are setting up a project for a Ventura EtherCAT master, the file is called "KuECAT.esm".

If you also click on "Yes" to answer prompt "Activate Free Run?", you can already test the Ventura FIO modules online.

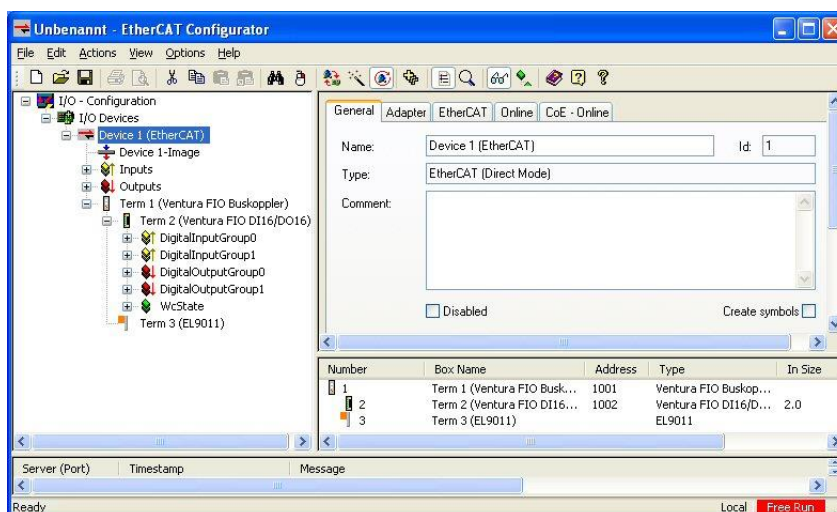

Set outputs only if you are sure that this will cause no harm.

7 Appendix

7.1 Technical data

7.1.1 Ventura FIO system properties

Fieldbus	EtherCAT 100Mbit/s
Dimensions.....	25mm x 120mm x 90mm (W x H x D)
Housing mount	aluminium
Shield.....	connected straight to module housing
Installation	35mm DIN rail (top-hat rail)
IO connection	spring-assisted combi plug with mechanical ejector, 4 ... 36-pin
Signal indication	LED located next to the terminal
Diagnosis.....	LED: bus state, module state, broken wire/excessive current
Number of ports.....	up to 32 digital I/Os on every module, up to 8 analogue channels per module
Supply voltage.....	24 VDC -20%/+25%
Number of I/O modules	20 per bus coupler (total max. power consumption: 3A)
Electrical insulation.....	modules electrically insulated from one another and from the bus
Storage temperature	-25°C ... + 70°C,
Operating temperature	0°C ... + 55°C
Rel. humidity.....	5% ... 95%, non-condensing
Protection	IP20
Susceptibility to noise.....	zone B to EN 61131-2, Installation on an earthed top hat rail in the earthed control cabinet

7.1.2 Ventura FIO bus coupler

Part no.	694.400.00
Fieldbus	EtherCAT 100Mbit/s 100 base TX to IEEE802.3
Connector	2x RJ45
Controller	ASIC ET1100
Extensions	connection to first Ventura FIO I/O module integrated in side panel of module
Diagnosis.....	LED: EtherCAT module state EtherCAT In/Out state

7.1.3 Ventura FIO I/O modules

Fieldbus	EtherCAT 100Mbit/s LVDS: E-bus
Controller	ASIC ET1200
Extensions	connection to adjacent Ventura FIO I/O modules integrated in side panels of module
Diagnosis.....	LED: EtherCAT state I/O state (collective message) * IO power supply state * state of every I/O (* if available)

7.1.3.1 Ventura FIO DI8/DO8 5ms/0,5A

Part no. 694.450.04
 Digital inputs 8, delay: 5ms
 Digital outputs 8, load 0.5 A, semiconductor (high side)

7.1.3.2 Ventura FIO DI8/DO8 1ms/0,5A

Part no. 694.450.05
 Digital inputs 8, delay: 1ms
 Digital outputs 8, load 0.5 A, semiconductor (high side)

7.1.3.3 Ventura FIO DI16/DO16 5ms/0,5A

Part no. 694.450.01
 Digital inputs 16, delay: 5ms
 Digital outputs 16, load 0.5 A, semiconductor (high side)

7.1.3.4 Ventura FIO DI16/DO16 1ms/0,5A

Part no. 694.450.03
 Digital inputs 16, delay: 1ms
 Digital outputs 16, load 0.5 A, semiconductor (high side)

7.1.3.5 Ventura FIO DI16/DO8 1ms/1A

Part no. 694.450.02
 Digital inputs 16, delay: 1ms
 Digital outputs 8, load 1 A, semiconductor (high side)

7.1.3.6 Ventura FIO DI16/DO16 LS 1ms/0,5A

Part no. 694.450.03
 Digital inputs 16, delay: 1ms (low-side)
 Digital outputs 16, load 0.5 A, semiconductor (low side)

7.1.3.7 Ventura FIO DI32 5ms

Part no. 694.451.04
 Digital inputs 32, delay: 5 ms

7.1.3.8 Ventura FIO DI32 1ms

Part no. 694.451.02
 Digital inputs 32, delay: 1 ms

7.1.3.9 Ventura FIO DI16 5ms

Part no. 694.451.01
 Digital inputs 16, delay: 5 ms

7.1.3.10 Ventura FIO DI16 1ms

Part no. 694.451.01
 Digital inputs 16, delay: 1 ms

7.1.3.11 Ventura FIO DO16 0,5A

Part no. 694.452.01

Digital outputs 16, load: 0.5 A, semiconductor (high side)

7.1.3.12 Ventura FIO DO8 1A

Part no. 694.452.02

Digital outputs 8, load: 1 A, semiconductor (high side)

7.1.3.13 Ventura FIO AI4-I 12Bit

Part no. 694.441.01

Analogue inputs 4

Resolution 12 bit

Measuring range 0(4) ...20mA (end value 21 mA)

Frequency 1,45 kHz (4 channels)

7.1.3.14 Ventura FIO AI8-I 12Bit

Part no. 694.441.04

Analogue inputs 8

Resolution 12 bit

Measuring range 0(4) ...20mA (end value 21 mA)

Frequency 0,76 kHz (8 channels)

7.1.3.15 Ventura FIO AI4/8-U 13Bit

Part no. 694.441.02

Analogue inputs 4x differential signal or 8x single-ended

Resolution 13 bit

Measuring range 0...10V, +/- 10V, +/- 5V, +/- 2.5V

Sampling frequency 1.12 kHz (8 channels)

7.1.3.16 Ventura FIO AI8/16-U 13Bit

Part no. 694.441.03

Analogue inputs 8x differential signal or 16x single-ended

Resolution 13 bit

Measuring range 0...10V, +/- 10V, +/- 5V, +/- 2.5V

Sampling frequency 0,52 kHz (16 channels)

7.1.3.17 Ventura FIO AO4, 12 bit

Part no. 694.442.02

Analogue outputs 4

Resolution 12 bit

Output signal 0..10V, +/- 10V, (if load < 10mA)

0(4)...20mA (if load < 560W) (adjustable)

Output frequency 3.125 kHz

7.1.3.18 Ventura FIO AI4-Pt/Ni100, 16 bit

Part no.....	694.443.01
Analogue inputs	4
Resolution	16 bit
Pt100 measuring range.....	- 75°C...+ 670°C
Ni100 measuring range.....	- 60°C...+ 250°C
Resistance meas. range ...	70...330 Ω
Sampling frequency	7,75 Hz (4 channels)

7.1.3.19 Ventura FIO AI8-Pt/Ni100, 16 bit

Part no.....	694.443.02
Analogue inputs	8
Resolution	16 bit
Pt100 measuring range.....	- 75°C...+ 670°C
Ni100 measuring range.....	- 60°C...+ 250°C
Resistance meas. range ...	70...330 Ω
Sampling frequency	3,88 Hz (8 channels)

7.1.3.20 Ventura FIO AI4-Pt/Ni1000, 16 bit

Part no.....	694.443.03
Analogue inputs	4
Resolution	16 bit
Pt100 measuring range.....	- 75°C...+ 570°C
Ni100 measuring range.....	- 60°C...+ 250°C
Resistance meas. range ...	70...3000 Ω
Sampling frequency	7,75 Hz (4 channels)

7.1.3.21 Ventura FIO AI8-Pt/Ni1000, 16 bit

Part no.....	694.443.04
Analogue inputs	8
Resolution	16 bit
Pt100 measuring range.....	- 75°C...+ 570°C
Ni100 measuring range.....	- 60°C...+ 250°C
Resistance meas. range ...	700...3000 Ω
Sampling frequency	3,88 Hz (8 channels)

7.1.3.22 Ventura FIO AI4-Thermo, 16 bit

Part no.....	694.443.05
Analogue inputs	4
Resolution	16 bit
mV measuring range.....	40 ..+65mV, Werte in 2μV
Type K measuring range...	-200°C .. +1372°C in 0,1°C
Sampling frequency	7,63 Hz (4 channels)

7.1.3.23 Ventura FIO AI8-Thermo, 16 bit

Part no.....	694.443.06
Analogue inputs	8
Resolution	16 bit
mV measuring range.....	40...+65mV, values in 2µV
Type K measuring range...	-200°C... +1372°C in 0,1°C
Sampling frequency	3,82 Hz (8 channels)

7.1.3.24 PROFIBUS-DP-Slave

Part no.....	694.455.01
Baud rate RS 232.....	1200... 11520 bit/s
Utilizable data.....	max 160 Byte In / 160 Byte Out

7.1.3.25 PROFIBUS-DP-Slave

Part no.....	694.455.03
Baud rate PROFIBUS	max. 12 Mbit/s
Utilizable data.....	max 160 Byte In / 160 Byte Out

7.1.3.26 Ventura FIO Counter2 5V

Part no.....	694.444.01
Encoder Inputs	2
Counting rate.....	max. 200kHz
Digital Inputs.....	8, 1ms delay
Digital Outputs.....	2, 2,0 A Load, high side semiconductor

7.1.3.27 Ventura FIO Counter/Posi2 5V

Part no.....	694.454.01
Encoder Inputs	2
Counting rate.....	max. 200kHz
Digital Inputs.....	8, 1ms delay
Digital Outputs.....	2, 2,0 A Load, high side semiconductor
Analog Outputs	2, -10V... +10V, 12 Bit

7.1.3.28 Ventura FIO Extender 2 Port

Part no.....	694.400.02
Connector.....	2 x RJ45

7.1.3.1 Ventura FIO MIX 02

Part no.....	694.444.62
Digital Inputs.....	4 x 1ms 1 x 0.1ms, 3 x 0.001ms delay
Digital Outputs.....	8 x 0.5A, 16 x 0.1A
Counter.....	1 (Clock, Direction, Reset)
Counter frequency.....	500 kHz (up to 1MHz)
Analog Inputs	4 x 0...+10V, 12 Bit
RS485	2.4..921.6 kBit/s electrically isolated

7.2 Order specifications

7.2.1 Ventura FIO Modules

Name	Part no.	ID no.	Technical data	IO/Power Connector
Ventura FIO bus coupler				
Ventura FIO bus coupler	694.400.00	149.789	Page 21	2-pole
Ventura Extender 2 Port	694.440.02	161.534	Page 125	-
Ventura FIO I/O modules				
Ventura FIO DI8/DO8 5ms/0,5A	694.450.04	162.649	Page 22	18-pole
Ventura FIO DI8/DO8 1ms/0,5A	694.450.05	151.650		
Ventura FIO DI16/DO16 5ms/0,5A	694.450.01	149.790	Page 25	36-pole
Ventura FIO DI16/DO16 1ms/0,5A	694.450.03	151.776		
Ventura FIO DI16/DO8 1ms/1A	694.450.02	176.617	Page 27	36-pole
Ventura FIO DI16/DO16 LS 1ms/0,5A	694.450.13	163.633	Page29	36-pole
Ventura FIO DI32 5ms	694.451.01	150.059	Page 31	36-pole
Ventura FIO DI32 1ms	694.451.03	155.028		
Ventura FIO DI16 5ms	694.451.01	150.059	Page 33	18-pole
Ventura FIO DI16 1ms	694.451.03	155.028		
Ventura FIO DO16 0,5A	694.452.01	150.060	Page 35	18-pole
Ventura FIO DO8 1A	694.452.01	176.618	Page 37	18-pole
Ventura FIO AI4-I 12 Bit	694.441.01	149.792	Page 43	18-pole
Ventura FIO AI8-I 12 Bit	694.441.04	149.792	Page 49	36-pole
Ventura FIO AI4/8-U 13 Bit	694.441.02	149.791	Page 54	18-pole
Ventura FIO AI8/16-U 13 Bit	694.441.03	150.796	Page 59	36-pole
Ventura FIO AO4, 16 Bit	694.442.01	150.847	Page 63	18-pole
Ventura FIO AO4, 12 Bit	694.442.02	149.793		
Ventura FIO AI4-Pt/Ni100, 16 Bit	694.443.01	154.262	Page 69	18-pole
Ventura FIO AI4-Pt/Ni1000, 16 Bit	694.443.03	154.141		
Ventura FIO AI8-Pt/Ni100, 16 Bit	694.443.02	154.263	Page 75	36-pole
Ventura FIO AI8-Pt/Ni1000, 16 Bit	694.443.04	154.142		
Ventura FIO AI4-Thermo, 16 Bit	694.443.05	154.145	Page 80	18-pole

Ventura FIO AI8-Thermo, 16 Bit	694.443.06	154.146	Page 85	18-pole
Ventura FIO RS232 1 Port	694.455.01	167.327	Seite 94	D-SUB 9-p.
Ventura FIO PROFIBUS-DP-Slave	694.455.03	162.290	Page 102	D-SUB 9-p.
Ventura FIO Counter2 5V	694.444.01	157.885	Page 119	36-pole
Ventura FIO Counter2 5V	694.454.01	157.884	Page 119	
Ventura FIO MIX 02	694.444.62	176.215	Page 126	36-pole

7.2.2 Ventura FIO Supplement

Name	Part no.	ID no.	Technical data	IO/Power Connector
Ventura FIO Potential Distributor				
Ventura FIO Potential Distributor 2x16	694.411.00	155.915	Page 136	36-pole
Ventura FIO Shield connection terminal block				
Ventura FIO Shield connection terminal block 2x8mm	694.412.01	154.008	Page 137	
Ventura FIO Shield connection terminal block 14mm	694.412.02	154.009		

Name	Part no.	ID no.
Ventura FIO Connector		
Ventura FIO Connector 2-pole 1 Piece	694.100.02.01	155.373
Ventura FIO Connector 18-pole 1 Piece	694.100.18.01	155.375
Ventura FIO Connector 36-pole 1 Piece	694.100.36.01	155.377
Ventura FIO Connector 2-pole 20 Pieces	694.100.02.20	155.374
Ventura FIO Connector 18-pole 20 Pieces	694.100.18.20	155.376
Ventura FIO Connector 36-pole 20 Pieces	694.100.36.20	155.378

Name	Part no.	ID no.
PROFIBUS plug		
PROFIBUS D-SUB plug, terminating resistor is switchable	645.180.00	93.288



*Only the 2-pole connector of the Ventura FIO Bus module is part of the module and will be automatically enclosed.
The 18- and 36-pole IO/Power-connectors and D-SUB-connectors are **not** part of the*

modules and have to be ordered separately.

7.3 References

<i>Title / Subject</i>	<i>Number</i>	<i>Source</i>
Instruction manual Ventura IPC	E 674 GB	http://www.kuhnke.com
Instruction manual Ventura INtime	E 647-6 GB	http://www.kuhnke.de
Technical Information Ventura FIO	E 740 GB	http://www.kuhnke.com
EtherCAT, technology, FAQs, downloads		http://www.ethercat.org

7.4 Sales & Service

Please visit our Internet site to find a comprehensive overview of our sales and service network including all the relevant addresses. You are, of course, always welcome to contact our staff at the main factory in Malente:

7.4.1 Main factory in Malente

Kendrion Kuhnke Automation GmbH
Lütjenburger Str. 101
D-23714 Malente
Phone +49-45 23-402-0
Fax +49-45 23-402 247
Email sales@kuhnke.de
Internet www.kuhnke.com

7.4.2 Customer service

Kendrion Kuhnke Automation GmbH
Lütjenburger Str. 101
D - 23714 Malente
Phone +49-4523 402 200
Email service@kuhnke.de
Internet www.kuhnke.com

7.5 Index

attention	10	AO4-U/I	60
cable routing and wiring.....	13	Bus coupler	20
configuration	137	Counter/Posi2 5V	101
offline.....	137	Counter2 5V	101
online.....	140	DI16.....	32
contamination	13	DI16/DO16	24
danger.....	9	DI16/DO16 LS.....	28
diagnosis		DI16/DO8	26
DP-Slave	96	DI32.....	30
DIN rail.....	16	DI8/DO8	22
earth.....	15	DO16	34
electromagnetic compatibility	12	DO8.....	36
electromagnetic interference	13	Extender 2 Port	118
impact and vibration	13	MIX 02.....	124
inductive actuators.....	13	PROFIBUS-DP-Slave	93
installation.....	11, 16	RS232 1 Port.....	84
installation instructions	12	note	10
instruction	10	order specifications.....	146
interference emission	12	preventive maintenance.....	11
LED		project planning	11
EtherCAT Run.....	19	reliability	9
In L/A.....	19	safety	11
IO	19	sales & service.....	150
Out L/A.....	19	servicing.....	11
Power	19	status LEDs	19
limiting value class.....	12	Supplement	
location of installation	13	Potential Distributor.....	134
mechanical design.....	14	Shield connection terminal block	135
modules		system description	14
AI4- Thermo element	74	system power supply	17
AI4/8-U	50	target group	9
AI4-I.....	38	Technical data	
AI4-Pt/Ni100.....	64	Summary.....	141
AI8- Thermo element	79	temperature	13
AI8/16-U	55	under construction	10
AI8-I.....	44	uninstall.....	16
AI8-Pt/Ni100.....	69	working steps.....	10