

User Guide

Original Operating Instructions

Kuhnke FIO Safety PLC

694 330 00

Safety PLC for the FIO System

E 842 GB 10. April 2024 / Document No. 10235625



Safety over
EtherCAT®

Table of Contents

1	Legal Notice.....	7
1.1	Contact Details	7
1.2	Version Details.....	7
1.2.1	Manual.....	7
1.2.2	Manual version / Safety PLC version	8
1.2.3	Terminology.....	8
2	Preface	9
2.1	About this User Guide	9
2.1.1	Limitation of Liability	9
2.1.2	Terms of Delivery	9
2.1.3	Copyright	9
2.1.4	Warranty.....	10
2.1.5	Symbols and Means of Presentation	10
2.2	Reliability, Safety	11
2.2.1	Applicability	11
2.2.2	Target Groups of the User Guide.....	11
2.2.3	Hazard and Other Warnings	11
2.2.4	Other Notices	11
2.2.5	Safety	12
2.2.6	Project Planning and Installation.....	13
2.2.7	Maintenance and Servicing.....	13
2.2.8	General Notes on Installation.....	13
3	System Description.....	15
3.1	Control System – Overview of Functionality.....	16
3.2	EtherCAT® – Ethernet Control.....	16
3.3	FIO system	17
3.4	FIO Safety System	18
3.4.1	Safety over EtherCAT (FSoE).....	18
3.4.2	Safety PLC	18
3.4.3	CODESYS Safety.....	18
3.4.4	PLCopen Safety Library in the CODESYS Environment.....	19
4	Product Description	20
4.1	Safety PLC.....	20
4.2	Application	20
4.2.1	Intended Use.....	20
4.2.2	Qualified Persons	22
4.2.3	Disclaimer of Liability	22
4.3	Safe State	23
4.3.1	Safe Functional State.....	23
4.3.2	Fail-Safe State.....	23
4.3.3	Traceability	24
4.4	Useful Life.....	24
4.5	Technical Data.....	25
4.5.1	General specifications.....	25
4.5.2	Size of FSoE Data Frame	26
4.5.3	Cycle time setting of the safety application.....	26
4.5.4	Response Time	27
4.5.5	Dimensions.....	29
4.6	Transport and Storage.....	30

5 Construction and Functionality	31
5.1 Labelling and Identification	31
5.1.1 Imprinted Texts and Symbols.....	31
5.1.2 Serial Number	32
5.2 Contents of Package	32
5.3 Status LEDs.....	33
5.4 Operating Software.....	34
6 Installation and Operation.....	35
6.1 Mechanical Installation	35
6.1.1 Mounting Position.....	36
6.1.2 E-bus Connector and Module Lock.....	36
6.1.3 To Snap on a Single Module.....	37
6.1.4 To Interconnect Two Modules.....	37
6.1.5 To Disconnect Two Modules.....	38
6.1.6 To Take Down a Single Module	38
6.2 Electrical Installation.....	39
6.2.1 Earthing.....	39
6.2.2 Module Interconnection.....	39
6.2.3 System Power Supply to the Series of Modules	39
6.3 Putting into Service.....	41
6.3.1 Configuration.....	41
6.4 Software Installation	41
6.4.1 Installing the Safety Extension	41
6.4.2 Installing the Safety Device Description.....	42
6.4.3 Creating a Safety Project	43
6.4.4 Safety PLC - Logging on and Downloading an Application	51
6.4.5 Safety PLC – FSoE (Safety over EtherCAT)	53
6.4.6 Setting the FSoE Slave IDs in the Safety PLC	53
6.5 Validation of Safety Functions.....	54
6.6 Diagnosis.....	54
6.6.1 Self-test	54
6.6.2 Safety PLC Module Errors	54
6.6.3 Temperature Faults	55
6.6.4 Error Handling and Logging	55
6.7 Resetting / Acknowledging Errors	55
6.8 Maintenance / Servicing	56
6.8.1 General.....	56
6.8.2 Servicing.....	56
6.9 Replacing a Safety PLC	56
6.9.1 Replacement Procedure	56
6.9.2 Restart.....	57
6.10 Durability.....	57
6.10.1 Repairs / Customer Service	57
6.10.2 Warranty.....	57
6.10.3 Taking out of Service	57
6.10.4 Disposal.....	58
7 Safety function blocks.....	59
7.1 CODESYS safety libraries and their function blocks.....	59
7.2 Kendrion Kuhnke safety library and its function blocks.....	59

Support of Additional Funktion Blocks – 210Bh	59
Library: KICS_Safety_Library	59
SF01_ECM - External Communication Monitoring	61
SF01_Scale_Verify	66
8 Appendix	69
8.1 Safety Ratings of the Safety PLC	69
8.2 Safety Ratings of the safety function blocks	69
8.3 Communication Objects	70
8.3.1 Device Type 1000h	70
8.3.2 Error Register 1001h	70
8.3.3 Device Name 1008h	70
8.3.4 Hardware Version 1009h	71
8.3.5 Software Version 100Ah	71
8.3.6 CANopen 'Restore Default Parameters' obj. 1011h	71
8.3.7 Identity Object 1018h	72
8.3.8 Error Settings (Not Used) 10F1h	74
8.3.9 Sync Manager Type (Not Used) 1C00h	74
8.3.10 SM out Par (Not Used) 1C32h	74
8.3.11 SM in Par (Not Used) 1C33h	74
8.4 Manufacturer-specific Objects	75
8.4.1 MC 1: Reference Voltage [mV] 2000h	75
8.4.2 MC 1: 5 V Supply Voltage [mV] 2002h	75
8.4.3 MC 1: 3.3 V Supply Voltage [mV] 2003h	75
8.4.4 Temperature Sensor [0.01 °C] 2006h	76
8.4.5 MC 1: Error Code 2007h	76
8.4.6 MC 1: Error Line 2008h	79
8.4.7 MC 1: Error Module 2009h	80
8.4.8 MC 1: Error Class 200Ah	81
8.4.9 MC 1: System Uptime [s] 200Ch	82
8.4.10 Read / Write World Time [s] (LOG Time) 200Dh	82
8.4.11 MC 3: 3.3 V Supply Voltage [mV] 2013h	82
8.4.12 Temperature Warning 2016h	82
8.4.13 MC 1: LZS ComponentId 2017h	83
8.4.14 MC 1: LZS FileId 2018h	83
8.4.15 MC 1: LZS Line 2019h	83
8.4.16 MC 1: Read Number of CORA Test Cycles 201Ah	84
8.4.17 MC 1: Read Number of File System Test Cycles 201Bh	84
8.4.18 MC 1: Read Number of IAR Test Cycles 201Ch	84
8.4.19 SW Build No 210Ah	84
8.4.20 Read MC 3 Error 2210h	85
8.4.21 Read MC 1 Runtimes 2220h	86
8.4.22 MC 3 Main Loop Cycle Time and Max Cycle Time 2221h	87
8.4.23 Free Disk Space / App Size Information 2230h	88
8.4.24 ST CPU Chip Id MC 1 (96-bit Serial Number) 5001h	89
8.4.25 ST CPU Chip Id MC 3 (96-bit Serial Number) 5003h	90
8.5 Objects for Internal Use Only	92
8.6 Standards Complied With	93
8.6.1 Product Standard Applied	93
8.6.2 Safety Standards and Directives	93

8.6.3 EMC Standards93

8.7 Directives and declarations94

8.7.1 Declaration of conformity94

8.7.2 RoHS 3 conformity95

8.7.3 TÜV certificate.....96

8.8 Table of Figures.....97

9 Sales & Service98

9.1.1 Malente Headquarters.....98

1 Legal Notice

1.1 Contact Details

Kendrion Kuhnke Automation GmbH
 Industrial Control Systems
 Lütjenburger Straße 101
 D-23714 Malente, Germany
 Tel. +49 4523 402-0
 Fax +49 4523 402-201
 Email sales-ics@kendrion.com
 Web www.kuhnke.kendrion.com

1.2 Version Details

1.2.1 Manual

Modification history		
Version	Date	Comments / modifications
1.00	03. Mar 2017	First Version
1.01	07. Mar 2017	Modification after review
1.02	05. Apr 2017	Modification after review
1.03	07. May 2017	Modification after review
1.04	31. May 2017	Modification after review
1.05	19. June 2017	Warning "Operation exclusively with ETG-compliant modules", update safety-related characteristic values
1.06	24. Aug 2017	Safety-relevant characteristic values after modification test TÜV Rheinland updated
1.07	26. Jan 2018	Objects 210A _h "SW Build No" and 2212 _h "Post Result Flag" added. User instructions for the safety task time setting added. Declaration of Conformity and TÜV Certificates inserted
1.08	19. Mar 2018	Note added to the ERRATA_Sheet_Safety Additionally: unique date format selected
1.09	26. Mar 2019	Changes in chapter 8.4.20 Read MC 3 Error 2210 _h for details see ERRATA_Sheet_Safety.
1.091	28. June 2022	Correction of the year of compliance with EN 61131-6:2012. Standard designation of the EMC standards adapted from DIN EN to EN. Update of the Declaration of Conformity, NotifiedBody address adapted. RoHS 3 conformity added.
1.11	10 April 2024	A note has been added to chapter 4.5.3 Cycle time setting of the safety application Chapter 6.4 Software Installation has been expanded to include the approved CODESYS versions with the appropriate safety packages and a link to a tutorial has been added. Chapter 7 Safety function blocks has been added. Chapter 8.2 Safety Ratings of the safety function blocks has been added.

1.2.2 Manual version / Safety PLC version

The following table describes the relationship between the module release (module version) and the corresponding manual version.

Module release			
Version	Manual	Date	Comments / modifications
V1.04	V1.09	26. Mar 2019	Applies to module release up to V1.04
V 1.05	V 1.11	10 April 2024	Applies to module release up to V1.05

1.2.3 Terminology

Terminology	
Term	Explanation
Safety PLC	The safety control unit described in this document
Standard PLC	Main control of the system that provides the EtherCAT master
CODESYS	Programming environment of the standard PLC
Safety package	CODESYS safety extension
PLCopen Safety	Certified library of safety function blocks
FIO system	Series of FIO modules
FIO PLC	Compact controller designed for the FIO system
Head module	Generic designation of a bus coupler or compact controller as part of the FIO system
CODESYS safety extension	Certified safety programming environment
Logical exchange variables	Let you exchange information between the safety PLC and the standard PLC (see CODESYS Safety Manual)

2 Preface

2.1 About this User Guide

This document is the manual for users of the Safety PLC module assigned product number 694 330 00.

For your work with the module, always consult the CODESYS Safety User Guide version certified for CODESYS Safety 1.2.0 as provided by 3S-Smart Software Solutions GmbH.

This document is intended for the target group described in section 2.2.2 Target Groups of the User Guide. It does not contain any availability information. We reserve the rights for errors, omissions and modifications. Pictures are similar.



Note, information

Please also note the ERRATA_Sheet_Safety for currently relevant safety warnings. The current version can be found in our product finder [Link](#).

2.1.1 Limitation of Liability

All specifications are only of a descriptive nature and must not be understood as guaranteed product properties in a legal sense. Exact properties and characteristics shall be agreed in the specific contract. Claims for damages against us - on whatever grounds - are excluded, except in instances of deliberate intent or gross negligence on our part.

2.1.2 Terms of Delivery

The general conditions of sales and service of Kendrion Kuhnke Automation GmbH shall apply.

2.1.3 Copyright

Copyright © Kendrion Kuhnke Automation GmbH

This user guide is protected by copyright.

No part of this document may be reproduced or copied in any way or by any means except expressly permitted in writing by Kendrion Kuhnke Automation GmbH.

Microsoft®, Windows® and the Windows® logo are registered trademarks of Microsoft Corp. in the USA and other countries.

EtherCAT® is a registered brand and patented technology, licenced by Beckhoff Automation GmbH, Germany.

Safety over EtherCAT is a registered trademark and patented technology, licenced by Beckhoff Automation GmbH, Germany

Further information about the PLCopen organisation is available at www.plcopen.org. CiA® and CANopen® are registered joint brands of CAN in Automation e.V. Title to all companies and company names mentioned herein as well as to products and product names is held by the respective enterprises.

2.1.4 Warranty

Warranty is subject to the provisions of the conditions of sale of BYKK Kendrion Kuhnke Automation GmbH or any contractual agreements between the parties.

The warranty will be voided by:

- improper assembly and use,
- repairs or inadmissible servicing,
- opening the module housing,
- modifying or removing the serial number or rendering it illegible.

2.1.5 Symbols and Means of Presentation

You will find the following symbols and means of presentation throughout this user guide:

Symbols and Means of Presentation	
Symbol	Explanation
→ ...	List item
▶ ...	Single instruction or list of instructions for actions that can be taken in any order.
1. ... 2. ...	List of instructions for actions to be taken in the specified order.
	Further product information

2.2 Reliability, Safety

2.2.1 Applicability

This user guide contains all the information you need to use the product described as intended.

2.2.2 Target Groups of the User Guide

The user guide is written for design, project planning, servicing and commissioning experts. For proper understanding and error-free application of technical descriptions, instructions for use and particularly of notes of danger and warning, extensive knowledge of automation technology and functional safety is compulsory.

2.2.3 Hazard and Other Warnings

Despite the actions described in section 2.2.5 Safety , the occurrence of faults or errors in electronic control units - even if most highly improbable - must be taken into consideration.

Please pay particular attention to the additional notices which we have marked by symbols throughout this user guide. While some of these notices make you aware of possible dangers, others are intended as a means of orientation. They are described further down below in descending order of importance.

Every alert and hazard warning is made up as follows:

WARNING

Optional:	Type and source of risk
Further symbols	Brief description of risk and potential consequences of non-observance ▶ Preventive measures

The signal words below are used for warnings you must respect for your own safety and to avoid material damage.

DANGER

A DANGER warning makes you aware of an immediately hazardous situation which WILL cause a serious or fatal accident if not observed.

WARNING

A WARNING makes you aware of a potentially hazardous situation which MAY cause a serious or fatal accident or damage to this or other devices if not observed.

CAUTION

A CAUTION alert makes you aware of a potentially hazardous situation which MAY cause an accident or damage to this or other devices if not observed.

2.2.4 Other Notices



Note, information

This symbol draws your attention to additional information concerning the use of the described product. This may include cross references to information found elsewhere (e.g. in other manuals).

2.2.5 Safety

Our products normally become part of larger systems or installations. The information below is intended to help you integrate the product into its environment without dangers to humans or material/equipment.

DANGER

Non-compliance with the user guide

Measures for the prevention of dangerous faults or errors may be rendered ineffective or new hazard sources created.

- ▶ Carefully read the user guide.
- ▶ Take particular heed of the hazard warnings.



To achieve a high degree of conceptual safety in planning and installing an electronic controller, it is essential to exactly follow the instructions given in the user guide because wrong handling could lead to rendering measures against dangers ineffective or to creating additional dangers.

2.2.6 Project Planning and Installation

- Comply with the safety and precautions regulations for qualified applications.
- Please pay particular attention to the notices of warning which, at relevant places, will make you aware of possible sources of dangerous mistakes or faults.
- Always comply with the relevant standards and VDE regulations.
- Control elements are to be installed in such a way as to exclude unintended operation.

2.2.7 Maintenance and Servicing

- Accident prevention regulations (in Germany: BGV A3 - VBG 4.0) to be observed when measuring or checking a controller after power-up. This applies to section 8 (Admissible deviations when working on parts) in particular.
- The Safety PLC module is maintenance-free, there are no spare parts
- You are not allowed to repair the Safety PLC module. Please return the defective module and a problem description to BYKK Kendrion Kuhnke Automation GmbH.
- De-energise the module before making changes to the structure or wiring. You may otherwise destroy the module or jeopardise its functionality. In addition, unexpected danger situations can arise, which can lead to accidents.

2.2.8 General Notes on Installation

As component parts of machines, facilities and systems, electronic control systems must comply with valid rules and regulations, depending on their field of application.

General requirements concerning the electrical equipment of machines and aiming at the safety of these machines are contained in Part 1 of European Standard EN 60204 (corresponds to VDE 0113).



In order to safely install the Safety PLC, take heed of the information in section 6 Installation and Operation and later.

Interference emission

Interfering emission of electromagnetic fields, HF compliant to EN 55011, limiting value class A, Group 1



If the controller is designed for use in residential areas, high-frequency emissions must comply with limiting value class B as described in EN 55011.

Fitting the controller into earthed metal cabinets and installing filters in the supply lines may produce a shielding compliant to the above standard.

The design and immunity to interference of programmable logic controllers are internationally governed by standard IEC 61131-2:2007 which, in Europe, has been the basis for European Standard EN 61131-2:2007 .



Refer to IEC 61131-4, User's Guideline, for general installation instructions to be complied with to ensure that hardware interface factors and the ensuing noise voltages are limited to tolerable levels.

Electrical immission safeguard

- ▶ To eliminate electromagnetic interference, connect the control system to the protective earth conductor.

Cable routing and wiring

- ▶ Keep power circuits separate from control circuits:
 - DC voltage, 60...400 V
 - AC voltage, 25...400 V
- ▶ Jointly lay the following control circuits only:
 - shielded data signals
 - shielded analogue signals
 - shielded digital I/O lines
 - unshielded DC voltages < 60 V
 - unshielded AC voltages < 25 V

Location of installation

- ▶ Ensure that temperatures, contaminations, impact, vibration or electromagnetic interference are no impediment to the installation.

Temperature

- ▶ Consider heat sources: general heating of rooms, sunlight, heat accumulation in assembly rooms or control cabinets.

Contamination

- ▶ Use suitable casings to avoid possible negative influences due to humidity, corrosive gas, liquids or conducting dust. (Eg installation in a suitable control cabinet).

Impact and vibration

- ▶ Consider potential influences caused by motors, compressors, transfer lines, presses, ramming machines and vehicles.

Electromagnetic interference

- ▶ Consider electromagnetic interference from various local sources: motors, switching devices, switching thyristors, radio-controlled devices, welding equipment, arcing, switched-mode power supplies, converters / inverters.

3 System Description

The Safety PLC integrates functional safety in the control system, making the separate wiring of safety circuits a thing of the past. The job of the Safety PLC is to run the safety application programme and to share the safety-related control information with the assigned safe slave modules.



Fig. 1: Safety PLC

Using the Safety PLC requires the use of a higher-level control unit based on CODESYS and referred to as the standard PLC below as well as EtherCAT as the fieldbus for data exchange.

3.1 Control System – Overview of Functionality

The picture below illustrates an example of a control system featuring a Safety PLC.

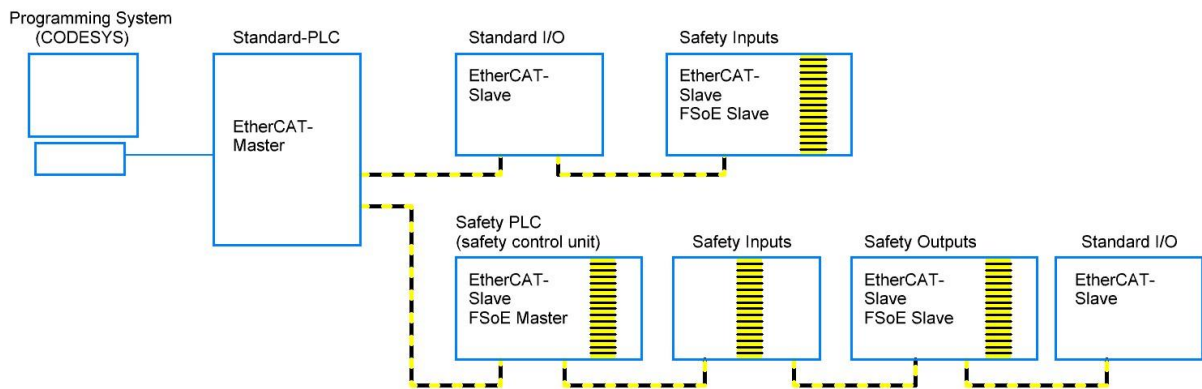

Fig. 2: System overview

Ethernet links the programming PC running the programming system with the standard PLC in order to program it. Making use of the EtherCAT fieldbus, the standard PLC may then program one or several Safety PLC.

In normal service mode, EtherCAT exchanges the process data between the standard PLC and the standard actuators and sensors.

At the same time, the Safety PLC uses the EtherCAT fieldbus and the protocol “FSoE” to exchange the safety-related signals with safe I/O modules or drives.

3.2 EtherCAT® – Ethernet Control

EtherCAT in an Ethernet-based fieldbus system whose speed makes it a good choice of a fast drive and I/O bus of control units (industrial PC or PLC).

Its interconnections between the controller at one end and both the I/O modules and drives at the other are as fast as those of a backplane bus. EtherCAT controllers thus nearly act like centralised control systems,

3.3 FIO system

The Safety PLC is a module of the FIO system which is a collection of stackable modules that integrate in an EtherCAT network for transferring the process signals.

Acting as the head module, the FIO bus coupler converts the twisted pair-based transfer to LVDS (E-bus) and generates the system voltages for the LVDS modules. The standard 100 Base Tx lines connect to the one side, the FIO modules for the process signals stack up at the other. This is how the EtherCAT protocol is retained right through to the last I/O module.

Instead of a bus coupler, the head module may also be an FIO PLC which will then also act as the standard PLC and the bus master.

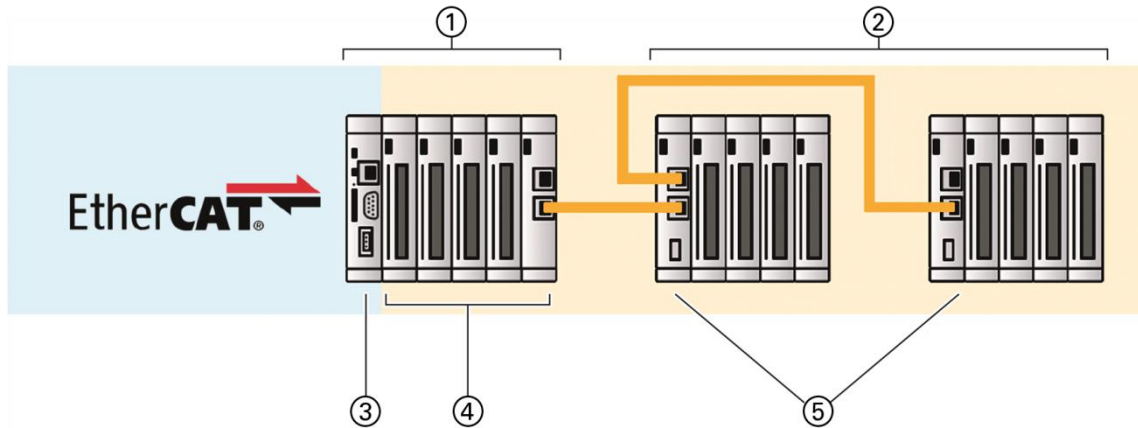

Fig. 3: FIO system

Item	Designation	Item	Designation
1	PLC with FIO expansion modules	4	Expansion modules
2	Bus coupler with FIO expansion modules	5	Bus coupler
3	FIO PLC		

3.4 FIO Safety System

The FIO safety system adds the Safety PLC of this guide and modules with safe inputs and outputs to the FIO module system, making the separate wiring of safety circuits a thing of the past. The EtherCAT protocol is used to transfer both safe and standard signals to the Safety PLC. This integration is based on the certified FSoE safety protocol.

3.4.1 Safety over EtherCAT (FSoE)

Along with EtherCAT, a safety protocol was developed and made available for EtherCAT as "Safety over EtherCAT" (FSoE = Fail Safe over EtherCAT). It is the backbone of providing functional safety over EtherCAT. Both the protocol and its implementation are certified to comply with Safety Integrity Level 3 (SIL 3) to IEC 61508. In 2010, IEC 61784-3-12 was published as the international reference standard for Safety over EtherCAT.

Since EtherCAT is used as a single-channel medium of communication, Safety over EtherCAT does not impose any constraints regarding the transfer rate and cycle time. The transport medium is considered a "black channel" which is left out of the safety assessment.



Fig. 4: FSoE logo

3.4.2 Safety PLC

The Safety PLC links the FIO safety system's inputs and outputs to the safety-related signals of other FSoE equipment of the installation.

It generally interacts with a higher-level CODESYS PLC referred to as the standard PLC in this guide. The Safety PLC has a two-channel architecture which supports communication with both the programming system via the standard PLC and with the standard PLC's non-safe variables and its inputs and outputs using logical exchange variables (see CODESYS Safety Manual - "Logical I/Os").

3.4.3 CODESYS Safety

A certified and fully integrated plug-in (safety package) of the CODESYS development system is used to program the safety PLC.

In the tree of units, the Safety PLC is shown under the standard PLC as an EtherCAT slave node with its own application, a task, lists of global variables, POU's and logical I/Os. It provides all functions described in the CODESYS® Safety Manual for CODESYS version 1.2.0, the only restriction being that the only way of integrating it is using EtherCAT as the medium of communicating with the Safety PLC.

The integrated function diagram (FD) safety editor (to IEC 61131-3, certified for use with IEC 61508 SIL3 applications) is used for basic or extended-level programming by means of certified function blocks (IEC 61131-3 or PLCOpen Safety) as specified in the CODESYS user manual.

At the basic level, certified function blocks (PLCOpen safety) are graphically "wired up" to establish the system's safety programme. In case a project demands more than the technology of the certified blocks can provide, the extra instructions available at the extended level can be used to expand the safety programme.

Further software functions are available for safeguarding the safety functions by change tracking, safe flow of signals, safe version control (pinning), separating safe operation, and debugging mode.



Fig. 5: CODESYS logo

3.4.4 PLCopen Safety Library in the CODESYS Environment

The PLCopen components have been defined and certified by the PLCopen organisation, its members and external organisations specialising in all safety-related aspects. The components interlink by logical operations which behave like logical wiring and admit the reliable programming of a safety application.



Fig. 6: PLCopen logo



The use of certified secure blocks alone does not guarantee that the user program is fault-free. Each program must be developed and thoroughly tested for safety.

4 Product Description

4.1 Safety PLC

The job of the Safety PLC is to integrate safety functions in a control system. The Safety PLC essentially consists of two microprocessors which implement the safety functions, exchange process data and mutually monitor one another. A third microprocessor manages all external communication processes.

To support its integration in an FIO system, the Safety PLC is designed as a stackable module which may be installed on a DIN rail in a switching cabinet.

General view:



Fig. 7: External features of the Safety PLC module

Item	Designation	Item	Designation
1	Grip	5	Shield-to-housing mount connector
2	Labelling clip	6	DIN rail mount and functional earth
3	Unlock button	7	Module lock, E-bus
4	Status LEDs	8	Ventilation slots

The housing mount consists of an aluminium profile with an integrated clamping fixture used to attach the module to a 35 mm DIN rail. The housing trough including the optical fibres for the status indicators, the side faces and the front are made of plastic and contain the module.

4.2 Application

4.2.1 Intended Use

The FIO system is a system of I/O modules for interconnecting the process signals in an EtherCAT network. It consists of the bus coupler and a range of I/O modules. The FIO safety system comprising the Safety PLC and the FIO safety module provides functions which allow the use of the FIO system for applications demanding the functional safety of machinery.

It is intended for applications requiring safety functions of machines or systems and all industrial automation tasks immediately associated with them. Thus, the system may only be used for applications providing a defined fail-safe state. By definition, a wattless state is "fail-safe". Running any of the safety-related control

components is subject to the safety precautions applicable to industrial control units, i.e. guarding by emergency stop and similar safety equipment as specified by the relevant national and/or international regulations. The same applies to connected equipment such as drives or light grids.

Before installing and putting the system into operation, the safety instructions, connection specifications (nameplate and documentation) and the limiting values listed in this user guide's Technical Data section must be read carefully and obeyed at any time. The system is not designed for applications causing potentially fatal risks or dangers to the life and health of many persons or disastrous ecological hazards unless exceptionally strict safety precautions are taken. Forbidden applications specifically include the monitoring of nuclear reactions in nuclear power stations as well as the control of flight or air traffic control systems, means of mass transit, medical life support systems and weapon systems.

In particular, only use within the framework of the applicable Machinery Directive (Directive 2006/42 / EC) is authorized.

WARNING

Impairment of safety when using unsuitable EtherCAT modules!

- ▶ The Safety-PLC may only be operated with ETG-compliant modules on one bus.

WARNING

Impairment of security when using unsuitable FSoE Slavemodule!

- ▶ The Safety PLC may only be used with FSoE compliant and certified slave modules.

4.2.2 Qualified Persons

The safety-related products may be used by the following persons only:

- Qualified persons who know the applicable concepts of functional safety as well as the relevant standards and regulations.
- Qualified persons who plan, design, install and put machine and system safety equipment into operation.

This manual's safety instructions construe qualified persons as persons whose training, experience, instructions and knowledge of the applicable standards, codes, accident prevention regulations and operating conditions authorise them to perform the required work and enable them to recognise and avoid potential hazards associated with that work. Language skills sufficient to understand this manual are therefore part of this qualification.

WARNING

Improper operation by unqualified persons!

- ▶ Have only properly qualified persons install and program the Safety PLC.

4.2.3 Disclaimer of Liability

The operator is responsible for self-reliantly running the safety-related control components in conformity with the requirements set by the competent authority.

The manufacturer shall neither be held liable nor accept any warranty for damages caused by:

- inappropriate use,
- non-compliance with standards and directives,
- unauthorised modifications of devices, connections or settings,
- the use of unapproved or unsuitable equipment or equipment groups,
- non-observance of the safety instructions contained in this manual.

4.3 Safe State

There are two different types of "safe states":

- The first one is functional and depends on the machine's application, operation and software. It is the aimed-for safe functional state at which the system works without problems.
- The second one is the fail-safe state assumed in response to any internal fault or error. The second one is the fail-safe state and is assumed in the case of an internal or externally detected fault.

4.3.1 Safe Functional State

The state is functionally safe when everything is working as it should.

It includes errors indicated to the Safety PLC by any of the modules connected to it. These errors generally do not change the safe functional state and are therefore handled by the safety application (e.g. loss of communication with a safe I/O module).

4.3.2 Fail-Safe State

Internal error

The state of the Safety PLC is considered "fail-safe" when valid FSoE frames are no longer sent to the associated safe FSoE slaves. In the absence of valid FSoE telegrams, the outputs of the FSoE slaves will change to safe state (Outputs currentless).

If affecting safety, internal errors are responded to by changing to the fail-safe state which also stops FSoE communication. To the extent possible, EtherCAT communication will still be enabled and provide diagnostic options.

External Error

The module monitors its supply voltage (high and low voltage) and the admissible operating temperature. Whenever either of the two is outside the admissible range, the Safety PLC changes to the fail-safe state and stops sending FSoE frames.

To quit the fail-safe state

The only way of quitting the fail-safe state is to turn off the power supply to the head module (bus coupler or PLC). Initialising after powering up again includes a complete self-test.

In conformity with the FSoE specification, FSoE slaves linked into the system will change to the safe state if a correct FSoE frame fails to be received before the watchdog times out.

4.3.3 Traceability

Traceability means that the time, place and entity that produced, processed, stored, transported, consumed or disposed of a product or trading good can be traced back at any time.

Whereas BYKK Kendrion Kuhnke Automation GmbH is able to meet this requirement with regard to production, processing, storage and transport, the purchaser is responsible for all further whereabouts of the product.

Identification and, thus, traceability of the product is ensured by its serial number which is printed on the front of the module and on a decal on the underside of the module. Or you can retrieve it by software means. To ensure proper traceability, the purchaser is obliged to note down this number together with the machine's name, place of installation and end customer.



The purchaser must ensure the units' traceability by means of their serial number.

4.4 Useful Life

The Safety PLC modules have a design life of max. 20 years after the date of manufacture (see section 5.1 Labelling and Identification). The module to be removed from service not later than one week before the end of this 20-year period (see section 6.10.3 Taking out of Service).



The date of manufacture is part of the serial number printed on the housing and stored in the Safety PLC's memory (see section 5.1.2 Serial Number).

4.5 Technical Data

4.5.1 General specifications

Designation	Value
Device data	
Product name	Safety PLC
Fieldbus	EtherCAT 100 Mbps
E-bus port	10-pin system plug in side wall
Memory for CODESYS application and configuration data	A total of 512kbytes are available: : <ul style="list-style-type: none"> • 400KByte for the CODESYS application • 112kByte for the configuration data
Electrical insulation	all modules electrically insulated from one another and from the bus
Diagnosis	LEDs (see section 5.3 Status LEDs)
E-bus load	max. 240 mA (system power supply)
Terminating module	module bus to be covered on the last module
System power supply	
Supply voltage	5 VDC via E-bus link supplied by the head module (bus coupler or PLC which are powered by 24 VDC, in accordance with EN 61131-2, min. -15% / +20% SELV/PELV)
Overvoltage category	category II to IEC 60664-1 in conformity with EN 61131-2
Reverse polarity safeguard	yes
Susceptibility to noise	install in zone B (61000-6-2 in conformity with EN61131-2), install on earthed DIN rail in an earthed switching cabinet. Lay the earth cable according to service conditions (see section 6.2.1 Earthing)
Storage and transport conditions	
Ambient temperature	-25 °C...+70 °C
Rel. humidity	5% ... 95%, non-condensing
Atmospheric pressure	70 kPa...108 kPa
Vibration	5 Hz...8.4 Hz: ±3.5 mm amplitude, 8.4 Hz...150 Hz: 10 m/s ² (1g) to IEC 60068-2-6, Fc test
Shock	150 m/s ² (15g), 11 ms semi-sinusoidal wave to IEC 60068-2-27
Service conditions	
Mounting position	horizontal, stackable
Degree of contamination	II to IEC 60664-3
Admissible operating environment	operation restricted to environments complying with IP54 or better to IEC 60529 (e.g. suitable control cabinet)
Operating temperature	0 °C...+55 °C
Relative humidity	5% ... 95%, non-condensing
Atmospheric pressure	80 kPa...108 kPa
Altitude of site	max. 2000 m above MSL
Vibration	5 Hz...8.4 Hz: ±3.5 mm amplitude, 8.4 Hz...150 Hz: 10 m/s ² (1g), to IEC 60068-2-6, Fc test

Shock	150 m/s ² (15g), 11 ms semi-sinusoidal wave to IEC 60068-2-27
Mechanical properties	
Installation	35 mm DIN rail (top-hat rail)
Dimensions (W x H x D)	25 mm x 120 mm x 90 mm
Ingress protection	IP20
Housing mount	aluminium
Shield	connects straight to module housing

4.5.2 Size of FSoE Data Frame

According to the FSoE protocol, the maximum frame size is 1322 bytes. This is also the maximum amount of data that a Safety PLC can exchange with the FSoE slaves.

To calculate the maximum number of FSoE slaves supported by a Safety PLC, just add up the safe I/O data of every slave plus the protocol overhead (the result corresponds to the size of the image). Refer to the product description of the FSoE slave in question to find the relevant size details.

Typical values for the size of the FSoE image of an FSoE slave depending on the safe I / O user data:

 Payload data (Bytes)	Value
1	6
2	7
4	11
8	19
16	35
32	67

The general rule:

Size of the FSoE image = 2 × secure I / O data + 3 byte data (CMD + Connection ID)

The minimum size of the image is 6 bytes

 A safety application will fail to start if its configuration exceeds the above maximum size of the FSoE data frame.

4.5.3 Cycle time setting of the safety application

The programming system is used to set the cycle time of the safety application. Settings in the range from 4 ms to 600 ms can be varied at steps of 1 millisecond.

 Values outside the range can not be set.
When the safety application is loaded onto the Safety PLC, a fault message is displayed.

For new safety projects it is recommended to set the safety task time to a high value (for example 50ms). When the project is running, the currently required safety task runtime can be read out in the object. (SDO object 2220 subindex 4) This value can then be accepted with a buffer (for example + 20%).

 It is advisable to determine the maximum value by polling the object between the start of the ECM and the start of the FSoE..

4.5.4 Response Time

The total response time of a safety system (consisting of the Safety PLC, safe I/O modules linked in via FSoE, and the sensors and actuators connected to the safe I/O modules) is made up of the signal processing times of each of the components (see picture below). The response time of the Safety PLC of this user guide equals the task cycle time set in the safety application.

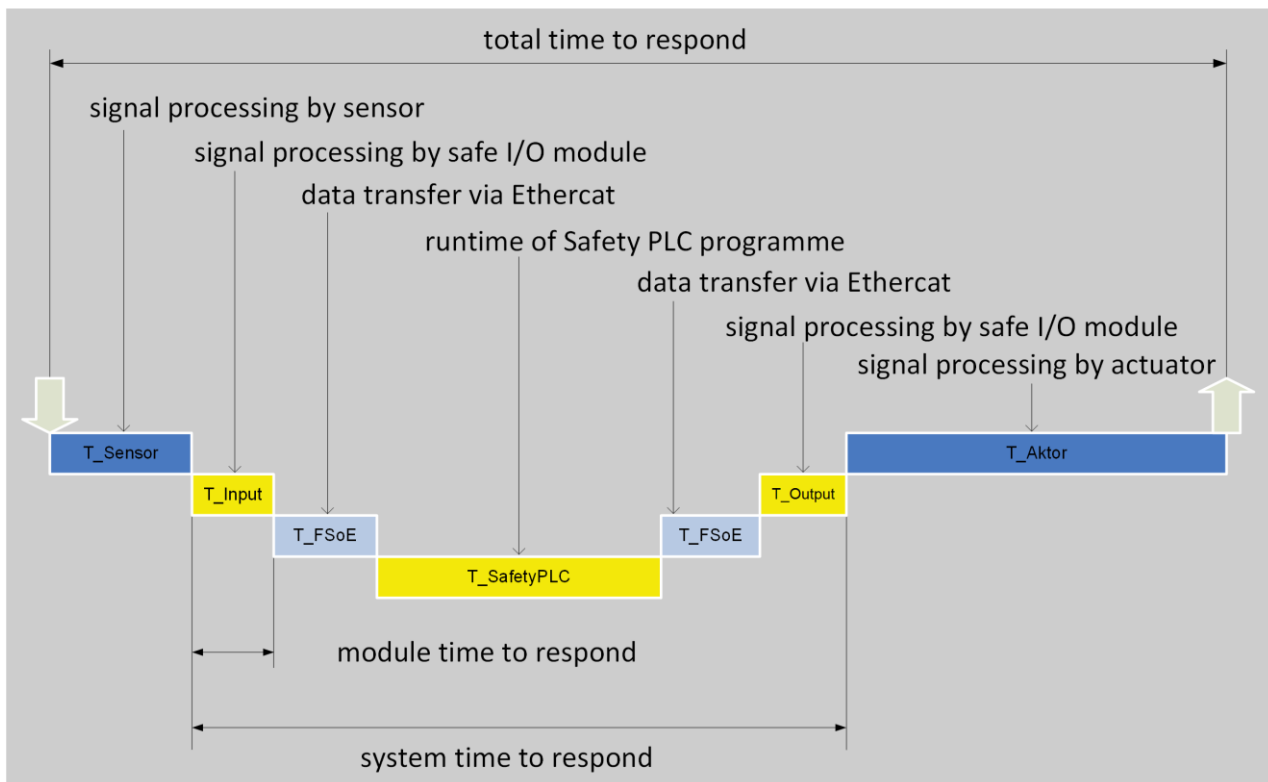

Fig. 8: Response time in the system group (example)

Definition	Description
T_Sensor	Sensor's processing time up until it delivers the signal to the interface. This time is normally specified by sensor manufacturer.
T_Input	Processing time of a safe input, e.g. a SDI4/SDO2 module. This time is listed among the input module's technical data.
T_FSoE	Communication processing time amounting to max. 3x the EtherCAT cycle time. This is due to the fact that sending any new data must wait for the next safety-over-EtherCAT frame and that, after sending, the higher-level standard PLC must first of all copy the data. The communication processing time therefore directly depends on the cycle time of the EtherCAT master.
T_SafetyPLC	Processing time of the Safety PLC which is the same as the cycle time set for the safety application. The Safety PLC will change to the safe state if this time is not achieved due to an excessive level of program complexity.
T_Output	Processing time of a safe output, e.g. a SDI4/SDO2 module. This time is listed among the output module's technical data.
T_Aktor	Actuator's processing time. This time is normally specified by actuator manufacturer.

CAUTION

To calculate the safe response time, take account of the fieldbus runtimes and the Safety PLC's cycle time.

- ▶ The fieldbus runtimes and the Safety PLC's cycle time must be taken account of to rate and calculate the safe response time.
- ▶ In the worst case, the fieldbus runtime must be assumed to amount to 3x the EtherCAT cycle time per direction of data transfer.



Since an error can occur during the Safety PLC cycle, the maximum system reaction time must always be assumed for the reaction time. This is adjustable by the Watch Dog time of the FSoE Slaves.

4.5.5 Dimensions

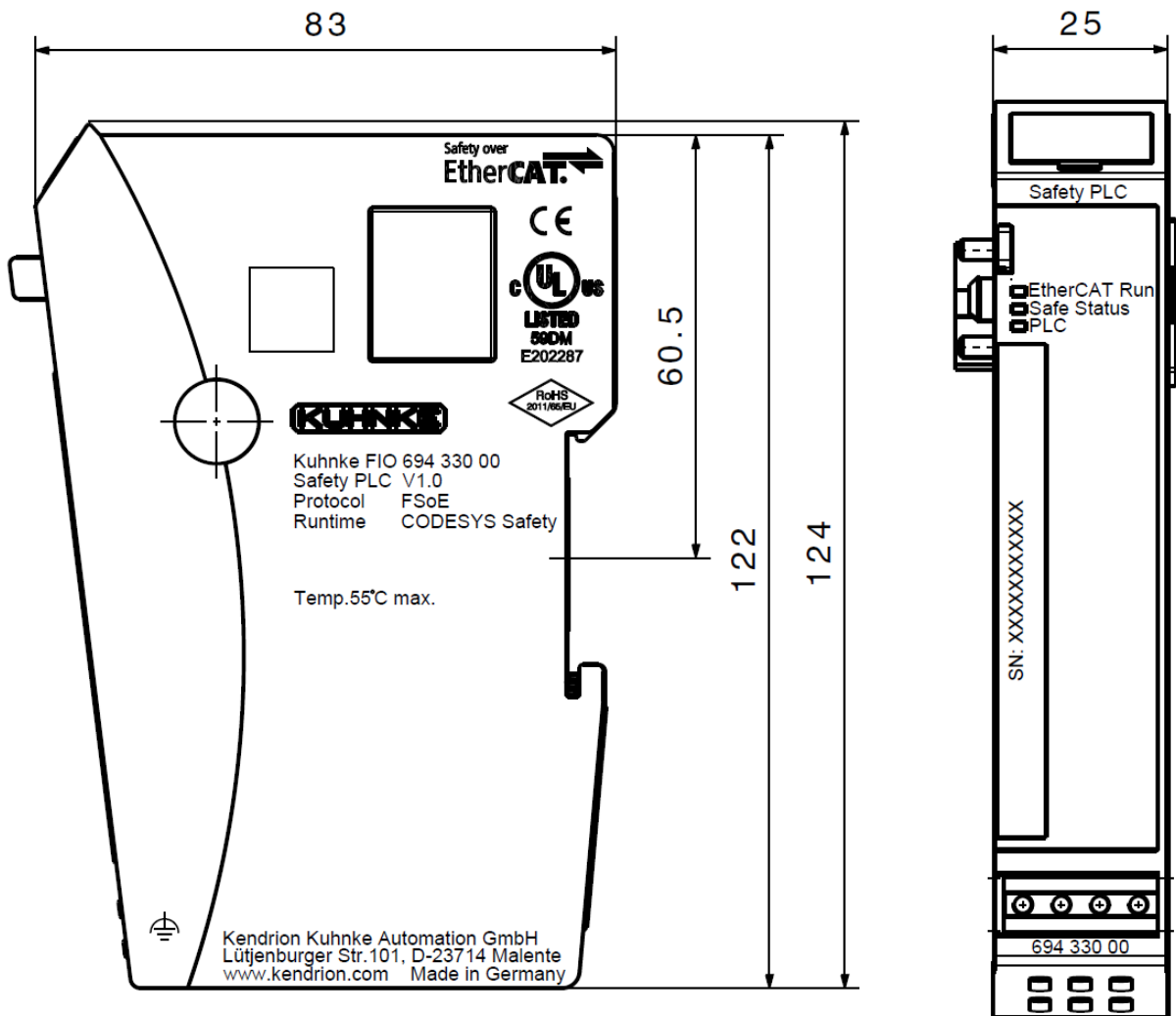

Fig. 9: Dimensions, in mm

4.6 Transport and Storage

At times of transport and storage, protect the Safety PLC against inadmissible exposure such as mechanical stress, temperature, humidity and/or aggressive atmospheres.

- ▶ Transport and keep the Safety PLC in its original packaging.
- ▶ Avoid soiling or damaging the contacts when picking the product or placing it in a different box.
- ▶ Keep and transport the Safety PLC in suitable containers/packages in due compliance with ESD instructions.

Some parts of the units are sensitive to ESD and may be damaged if handled inappropriately.

- ▶ When putting the Safety PLC module into service or when doing any maintenance, take the required precautions against electrostatic discharge (ESD).

CAUTION

Electrostatic discharge!

Destruction of or damage to the unit.

- ▶ Use the original packaging for transporting or storing the Safety PLC module.
- ▶ Ensure that the ambient conditions are as specified at all times during transport and storage.
- ▶ Handle the Safety PLC modules in a well-earthed environment (persons, place of work, packaging).
- ▶ Do not touch electrically conductive parts such as data contacts. Some of the electronic components may be destroyed if exposed to electrostatic discharge.

5 Construction and Functionality

5.1 Labelling and Identification

5.1.1 Imprinted Texts and Symbols

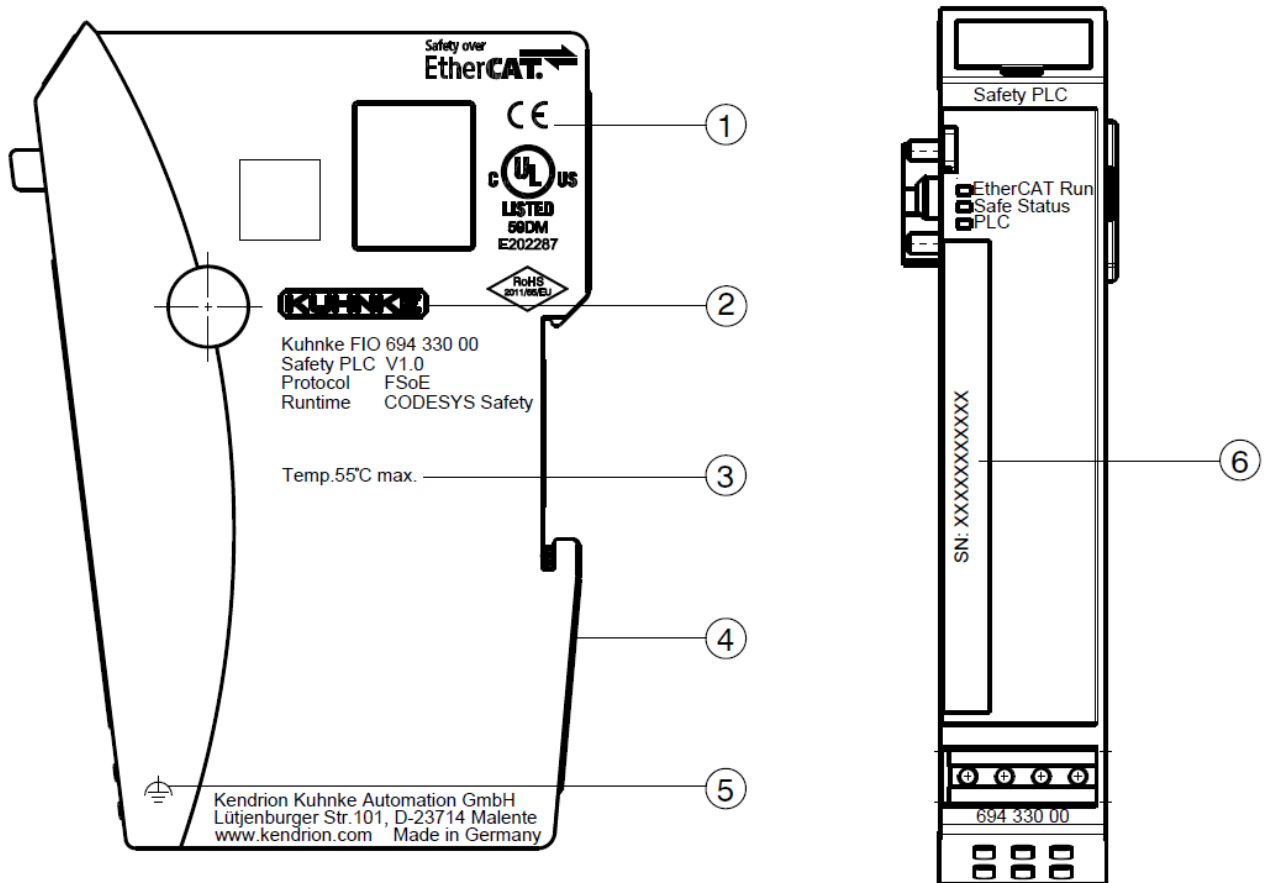

Fig. 10: Imprinted texts and symbols

Item	Designation	Item	Designation
1	mark of approval	4	serial number on underside
2	manufacturer's label	5	operative earth
3	operating conditions	6	serial number on front side

5.1.2 Serial Number

The serial number is vertically printed on the front panel. You will also find it on the decal on the back of the module.

The numerical code incorporates the production date and a serial number. It allows BYKK Kendrion Kuhnke Automation GmbH to identify the unit's history, model, software and hardware revision.

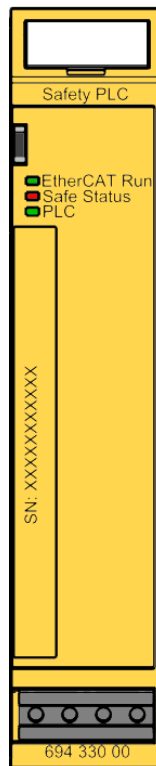

Fig. 11: Front view showing the serial number (SN)

Make-up of serial number: YY MM DD NNNNN

Y = year (production date)

M = month (production date)

D = day (production date)

N = consecutive number



The serial number is also stored in sub-index 4 of object 1018_h and can be accessed by an EtherCAT SDO (see section 8.3.7 Identity Object 1018_h).

5.2 Contents of Package

- Safety PLC
- Module bus cover

5.3 Status LEDs

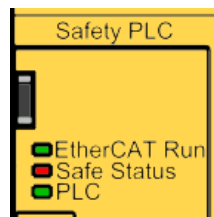

Fig. 12: Status LEDs

Indicators:

- LED "EtherCAT Run": state of EtherCAT communication
- LED "Safe Status" (duo LED): state of the module regarding its safety function
- LED "PLC ": state of the module

LED	State	Explanation
LED "EtherCAT Run"		
Off	Init	Initialising, no data exchange
Off/green, 1:1	Pre-Op	Pre-operational, no data exchange
Off/green, 5:1	Safe-Op	Safe operation, inputs readable
Green, on	Op	Operational, unrestricted data exchange
LED "Safe Status"		
Green, on	OK	Module in safe functional state
Red, on	Error	Module in fail-safe state
LED "PLC "		
Off	–	Safety application not loaded
Off/yellow, 1:1	–	Loading safety application
Yellow, on	–	Safety application loaded
Green, on	–	Executing safety application
Red, on	–	Safety application stopped
Off/red, 1:1	–	Safety application aborted
Off/green, 1:1	–	Safety application in debug mode

i The status LEDs are not a safety-related display. That The status display via the LEDs must not be used alone as a safe indicator for the operating state of the module, etc.

5.4 Operating Software

The Safety PLC is part of a distributed control system based on CODESYS. The Safety PLC is programmed using a programming system based on CODESYS and extended by a certified plug-in (CODESYS safety extension) which provides the safety functions.

WARNING

Wrong programming and parameter setup!

- ▶ Verify that the CODESYS safety extension used for programming and parameter setup is approved for use with the CODESYS safety runtime system version 1.2.0.
- ▶ Programming and parameter setup to take heed of the correct CODESYS user guide.

6 Installation and Operation

- ▶ Before installing the safety module, verify that it has been transported and stored at the ambient conditions specified in sections 4.6 Transport and Storage and 4.5 Technical Data.
- ▶ Module operation is subject to the service conditions specified in section 4.5 Technical Data.

CAUTION

Inappropriate operation!

Malfunction of the Safety PLC module.

- ▶ Only persons qualified for dealing with safety matters are allowed to add, replace and put Safety PLC modules into operation.
- ▶ Prior to installing, servicing or putting the Safety PLC module into operation, read the safety instructions contained in this documentation.
- ▶ Prior to putting the module into operation, verify that all safety functions work as specified (validation of safety functions).

6.1 Mechanical Installation



No tools are required to install and uninstall Safety PLC. Please refer to Chapter 6.1.3 to 6.1.6

Environment of installation

Protect the unit against inadmissible contamination (comply with contamination degree II of IEC 60664-3).

A suitable means would be an IP54 enclosure, e.g. a suitable switching cabinet. Operation under condensing humidity is NOT allowed.

WARNING

Potentially hazardous failures due to contamination!

Contaminations more severe than those described for degree of contamination II of IEC 60664-3 may cause potentially hazardous failures.

- ▶ Do ensure that the operating environment complies with at least IP 54, e.g. by installing the unit in a suitable control cabinet.

6.1.1 Mounting Position

The unit is intended for installation on a rail (to DIN EN 50022, 35 x 7.5 mm). Mount the DIN rail horizontally and check that the module's status LEDs are at the front.

To ensure that enough air gets in through the ventilation slots, leave at least 20 mm to the top and 35 mm to the bottom of a module and any adjacent devices or cabinet surfaces. Leave at least 20 mm of lateral distance to third-party units and cabinet surfaces.

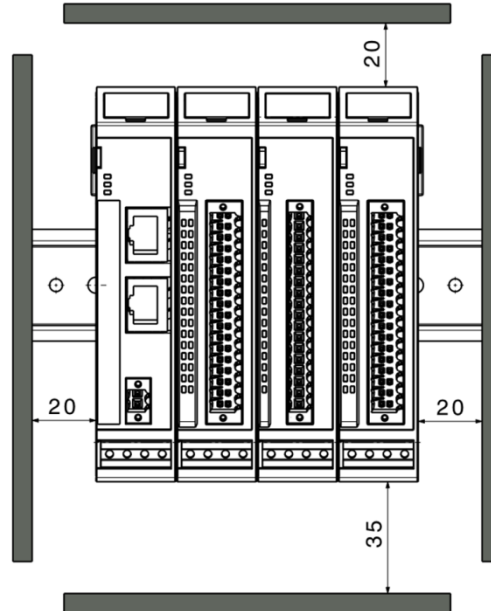

Fig. 13: Mounting position and minimum distances, in mm

6.1.2 E-bus Connector and Module Lock

The system connectors and the module lock are located on the sides of the Safety PLC module. These contact pins interconnect the modules. They supply power to the module's electronic circuitry and transfer the EtherCAT signals. Leave the end cap from the package in place to protect the module bus connector of the last module to the right of the terminal unit against contamination.

The integrated module lock prevents the modules from coming apart under mechanical load or vibration.

6.1.3 To Snap on a Single Module

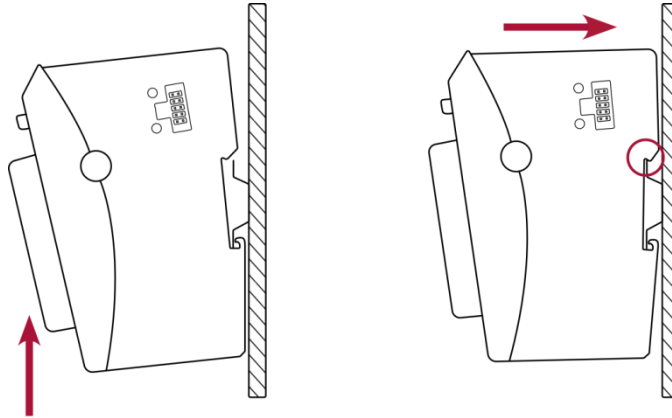

Fig. 14: Mounting a module

- 1st Push up the module against the mounting rail from below, allowing the metal spring to snap in between mounting rail and mounting area as illustrated.
- 2nd Push the top of the module against the mounting wall until it snaps in.

6.1.4 To Interconnect Two Modules

- 1st If a module has previously been snapped on to the rail, place the next module about 1 cm away from it to the right and snap it on.
- 2nd Then push the new module left towards the other module until the unlock button snaps out.
- 3rd To prevent inadmissible contamination, mount the cover of the module bus connector on the rightmost module of the FIO system.

CAUTION

Risk of injury by the module bus contacts shorting out!

A short of the module bus contacts may cause the communication with the safe module to fail.

- ▶ Verify that the end-of-bus cap is in place on the last module of a series of modules.

6.1.5 To Disconnect Two Modules

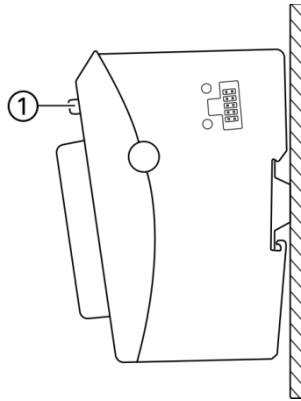

Fig. 15: Disconnecting modules

- 1st Push the unlock button (1) of the module you wish to remove.
- 2nd Push both modules about 1 cm apart.

6.1.6 To Take Down a Single Module

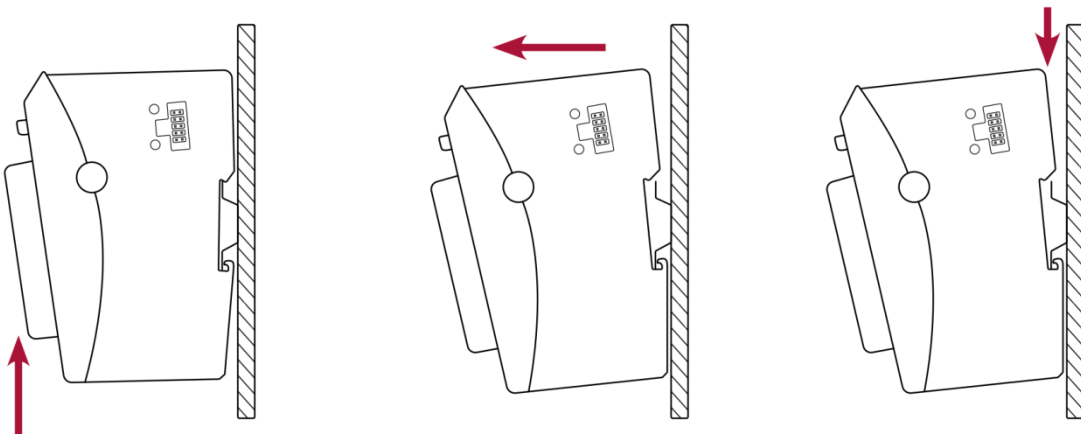

Fig. 16: Removing a module

- 1st Push the module up and against the metal spring located on the underside of the rail guide.
- 2nd Tip the module forward and away from the rail as shown in the illustration.
- 3rd Pull the module down and out of the mounting rail.

6.2 Electrical Installation

6.2.1 Earthing

Every module needs to be earthed by connecting the internal metal housing to functional earth which dissipates HF currents and is of utmost importance to the module's immunity to noise.

HF interference is dissipated from the electronics board to the metal housing. The metal housing therefore needs to be suitably connected to a functional earth connector.

Snapping the module on to the rail normally provides a high-conductivity earth connection between the module housing and the rail. The rail has a high-conductivity connection to the switching cabinet which is earthed well in itself.

If need be, the earth connection can be screwed to the front of the module (see (1) in the figure below).

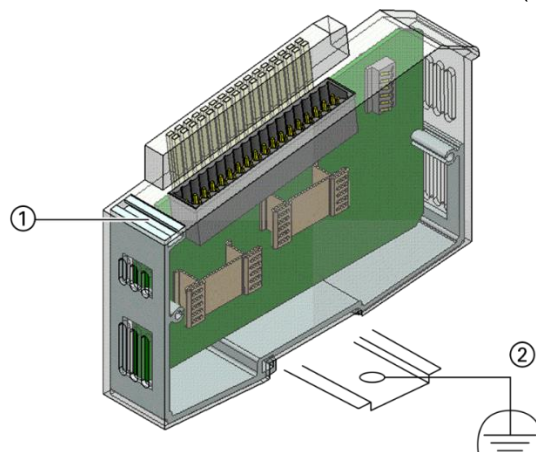

Fig. 17: Earthing (example of an I/O module)

Item	Designation	Item	Designation
1	Earthing/cable shield, connected by a M3x5 bolt	2	DIN rail, connected to functional earth

i Earth wires should be short and have a large surface (copper mesh).

i When installing production or other lines, measure the earth potential of the DIN rail as specified in the applicable guidelines (earth test to VDE 0100). Measuring the earth potential must show that every protective and operational earthing is within the boundaries set by the applicable standards.

- ▶ Also consider the repeat testing frequency resulting from the hazard assessment.

6.2.2 Module Interconnection

The modules electrically interconnect by completely pushing the modules together. This automatically connects the modules to both the EtherCAT bus and the system power supply. Refer to section 6.1 "Mechanical Installation" for details about how to interconnect two modules.

6.2.3 System Power Supply to the Series of Modules

i To supply the Safety PLC only modules may be used (Bus couplers, small controllers in compliance with EN 61131-2), which have a polarity reversal protection for the 24V voltage supply.

Power to each module's logical circuitry is supplied by the head module (compact controller or bus coupler) via the modules' backplane bus. The number of stackable modules depends on the head module's power output. A typical power output of 3 A supports up to about 20 modules. To link in a larger number of modules, just make up blocks of modules and have a separate bus coupler supply power to each of the blocks.



- ▶ Take note of the system power supply details provided in the operating instructions of the upstream bus couplers or compact PLCs as well as the additional system power supply instructions in this user guide.
- ▶ Note that the maximum current supplied by the head module limits the number of modules you may connect to a single block.



- The number of interconnected modules provokes varying voltage ratios on the E-bus with reference to the module position.
- ▶ In order to provide a maximum of availability, try to place the Safety PLC module as close to the head module as possible.

WARNING

Damage caused by wrong power supply!

Supplying the wrong voltages may damage or destroy the unit.

Preventive measures:

- ▶ Only use PELV/SELV-ready power supply units to EN50178 or EN60950-1 to supply 24 VDC to bus couplers or compact PLCs that any Safety PLC modules are connected to.
- ▶ Only use the GND terminal to connect the power supply unit to earth (PELV system). Do not use earthing variants that connect earth to +24V.
- ▶ To ensure that there is as little interference as possible, install a central power supply point and establish a star topology of as short wires as possible between the central point and the block of FIO modules.

6.3 Putting into Service



The Safety PLC may only be operated with FSoE-compliant FSoE slaves.

Whenever you work on the safety system, check that the safety functions are provided properly afterwards.

6.3.1 Configuration

Only the operating software is used to configure the Safety PLC. The module as such does not provide options to change any of the settings.

6.4 Software Installation

As a general rule, only the 32-bit version of CODESYS is currently approved for use with CODESYS Safety. The following versions are currently approved by us:

CODESYS Version	Safety Package Version
32Bit CODESYS V3.5.8.30	Safety Package V1.2.0.0
32Bit CODESYS V3.5.14.40	Safety Package V1.5.0.0
32Bit CODESYS V3.5.16.40	Safety Package V1.6.1.0

There is a tutorial which explains the first steps up to the creation of a safety program.

https://www.youtube.com/watch?v=_DQit8ErxeM

6.4.1 Installing the Safety Extension

The safety extension you need for the safety PLC needs to be manually integrated in the programming system. Once CODESYS has been installed, you just need to double-click on the installation file to also install the CODESYS safety extension.

Another method is to run CODESYS and go to tab "**Tools -> Package Manager... -> Install...**" to install the extension.

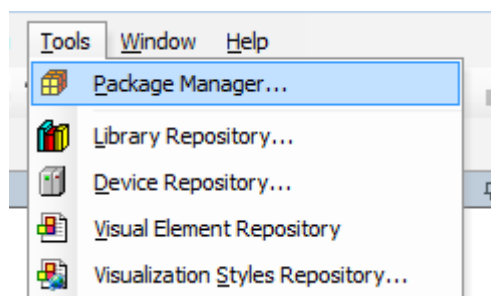

Important: Note that, in either case, you need administrator privileges to install the extension.

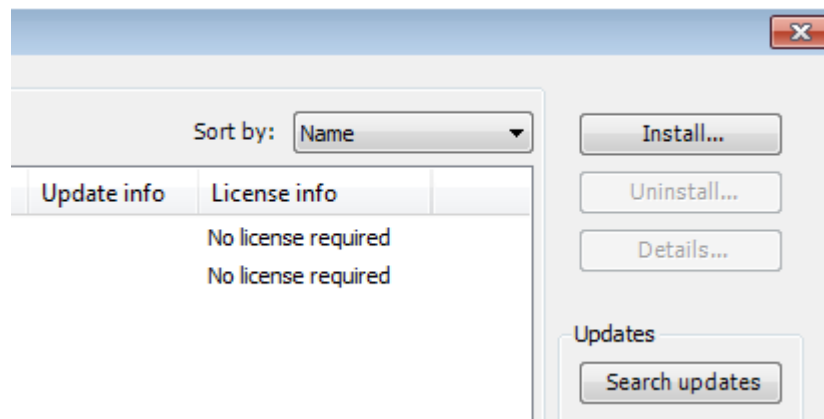

- ▶ After completing the installation, restart the CODESYS programming system.

6.4.2 Installing the Safety Device Description

Before you can use an EtherCAT module, you must first install the associated device description. This also applies to safety modules (Safety PLC and its I/O modules).

To install a device description (*.xml) in CODESYS, go to tab "**Tools -> Geräte Repository**" (Tools -> Device Repository).

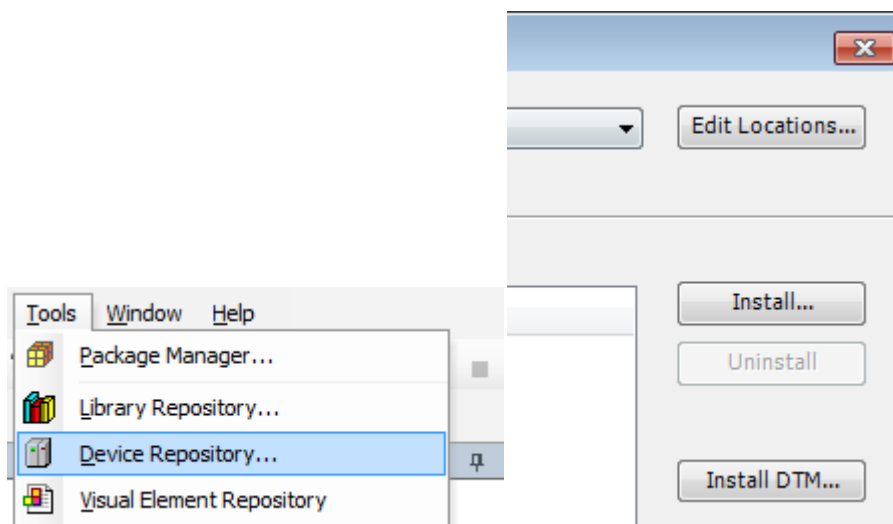

Before you can use the Safety PLC and any of the other devices in a project, mind to first of all install their device description in the device repository.



Note: CODESYS package files and device description should always be installed by a user owning administrator privileges.

6.4.3 Creating a Safety Project

- 1st Start CODESYS V3.
- 2nd On the standard CODESYS home page, go to "**Basisoperationen**" (Basic Operations) and click on "**Neues Projekt...**" (New Project).

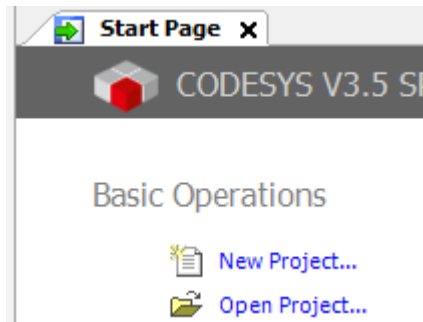

Or choose "**Datei -> Neues Projekt...**" (File -> New project) to create a new project.

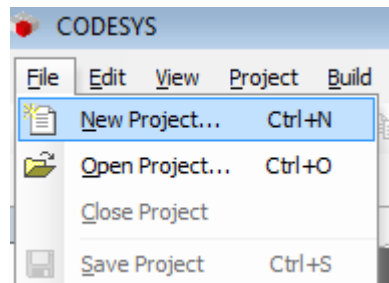

- 3rd Pick template "**Leeres Safety Projekt**" (Empty Safety Project).
- 4th Assign a "**Name**", choose a storage location, and click on "**OK**" to actually create the project.

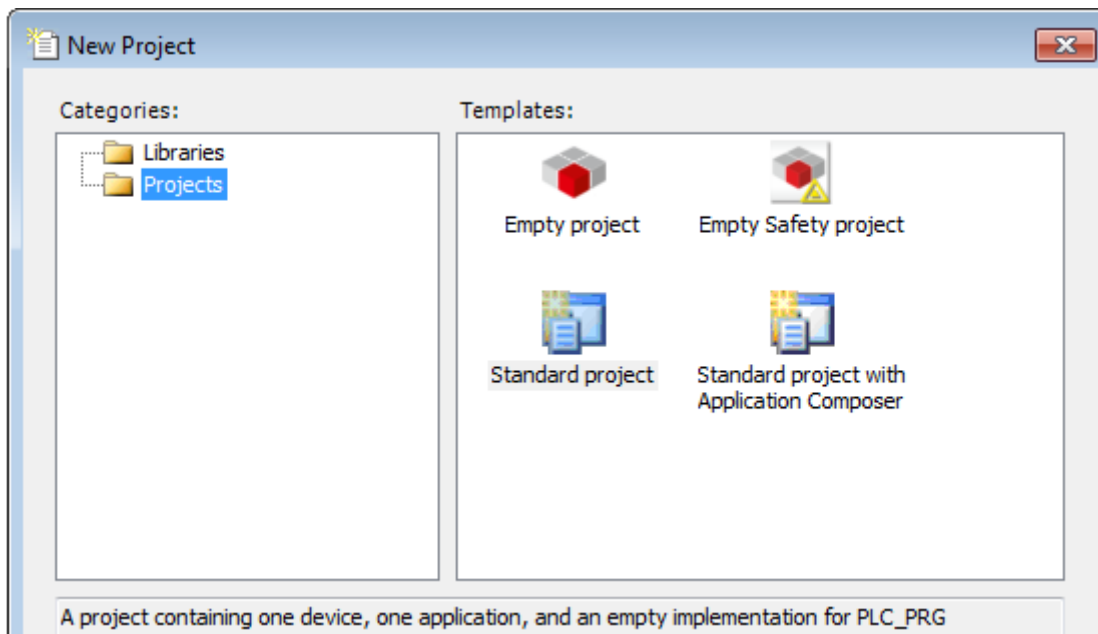

- 5th Add a standard PLC to the empty project by right-clicking on "**[project name] -> Gerät anhängen**" (Add Device).

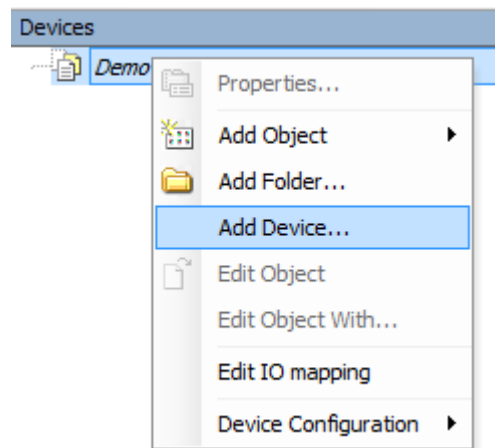

6th Pick the correct type of your standard PLC.

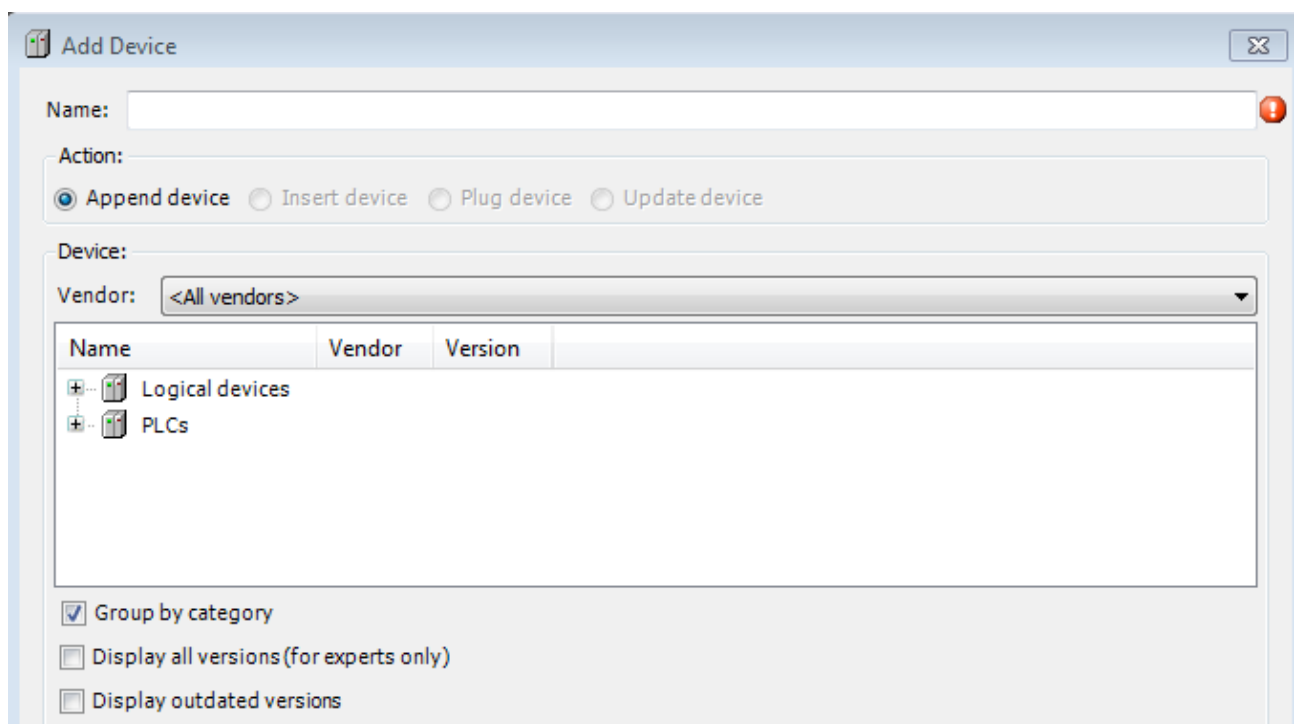

7th To add objects to your application, right-click on "**Application -> Objekt hinzufügen**" (Add Object).

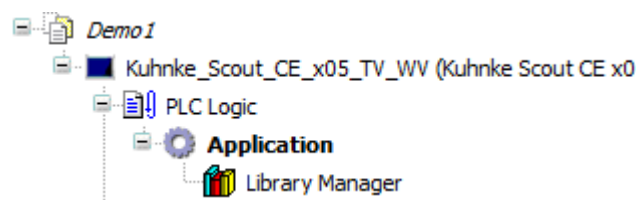

A list of available objects appears.

Click on any of the objects to add it to the application.

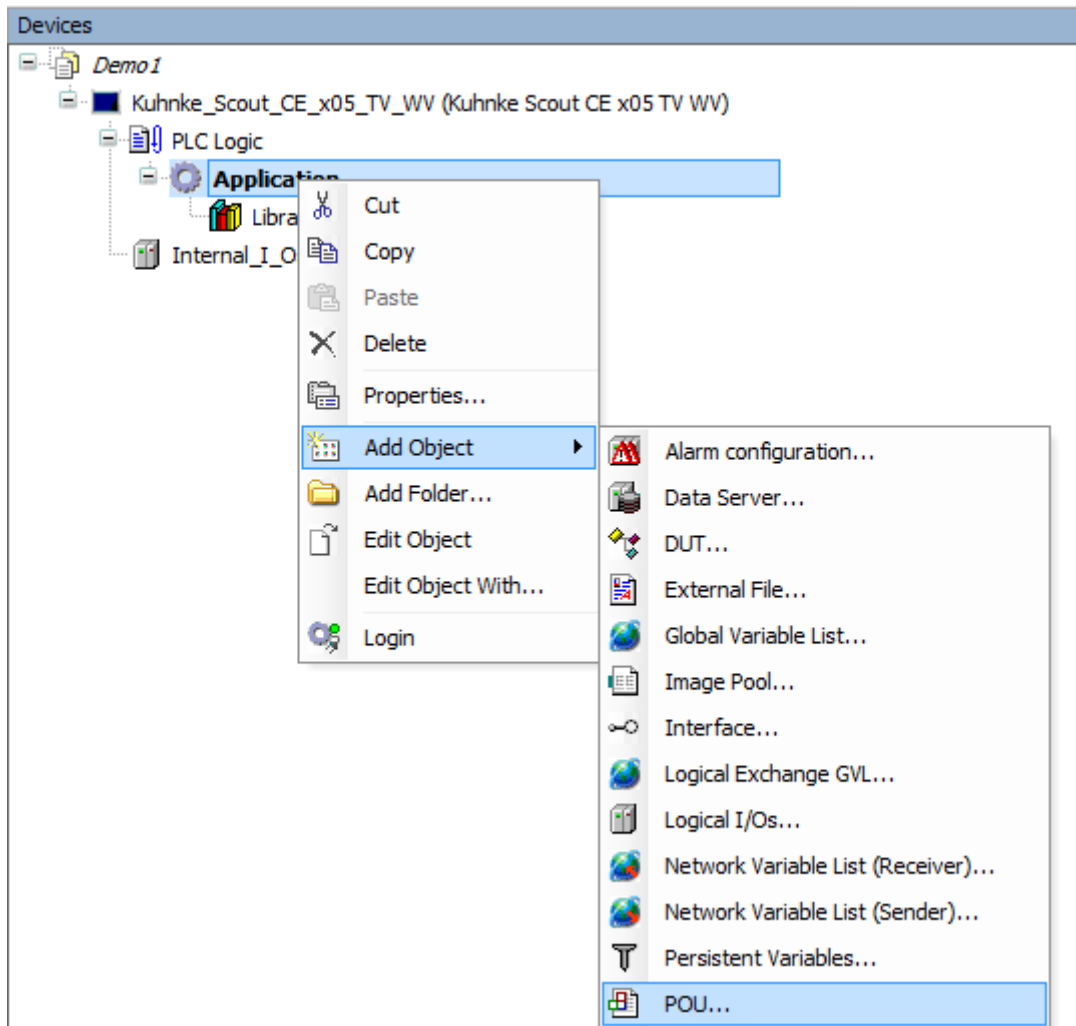

- 8th Add a POU (programme). Assign a name, here "PLC_PRG".
- 9th Add a task configuration.
- 10th To run the POU using the task configuration:
Click on "**Aufruf hinzufügen**" (Add Call) and pick the POU from the list.

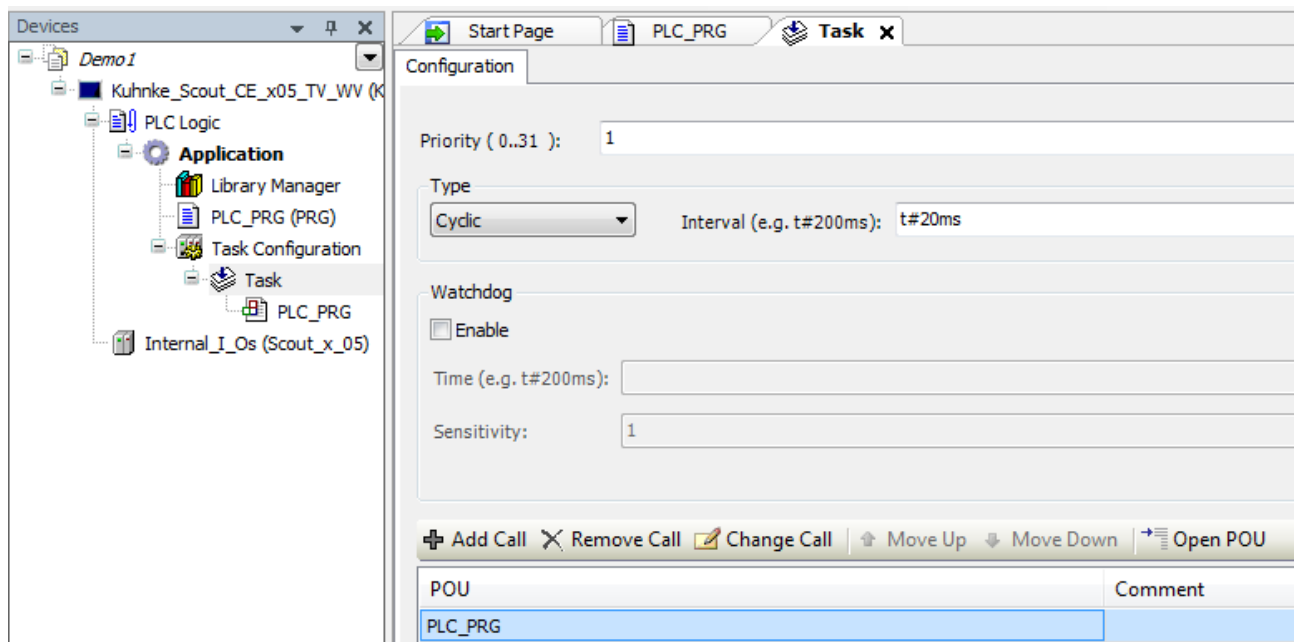

Since the Safety PLC is an EtherCAT-based module, you will still need an EtherCAT master:

11th Right-click on the standard PLC you added before.

12th In the dialog, click on "**Gerät anhängen...**" (Add Device).

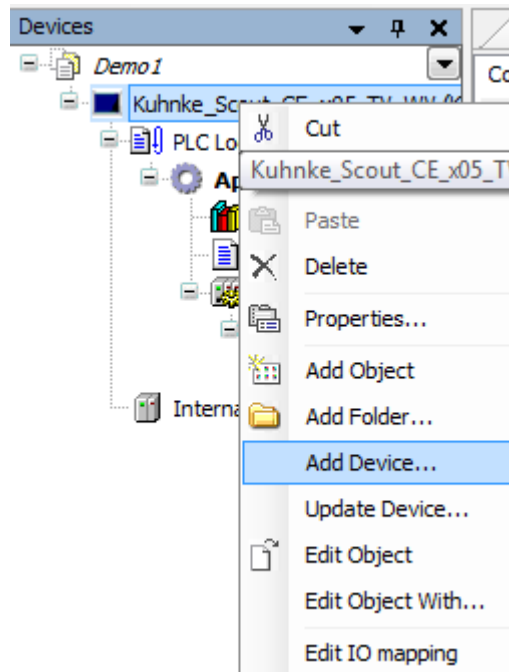

13th In the next dialog, choose "Feldbusse -> EtherCAT -> Master -> EtherCAT Master" (Fieldbuses -> EtherCAT -> Master -> EtherCAT Master).

14th Click on "Gerät anhängen" (Add Device) to add the EtherCAT master to your project.

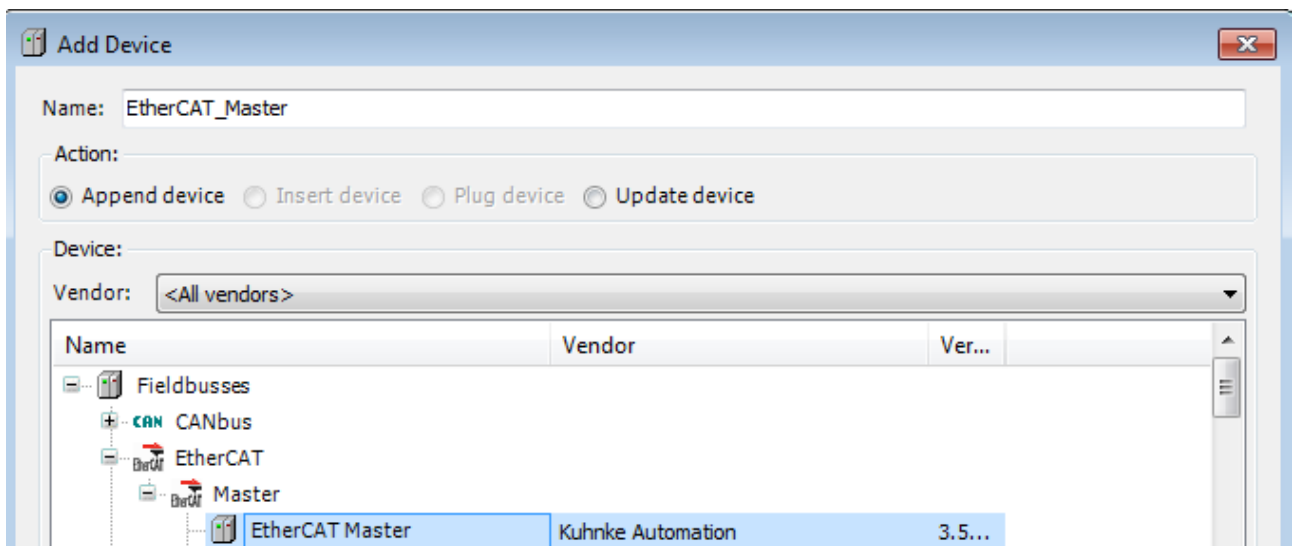

The EtherCAT master has been added to the list of devices and, thus, to your project. The EtherCAT master's task configuration has been create automatically.

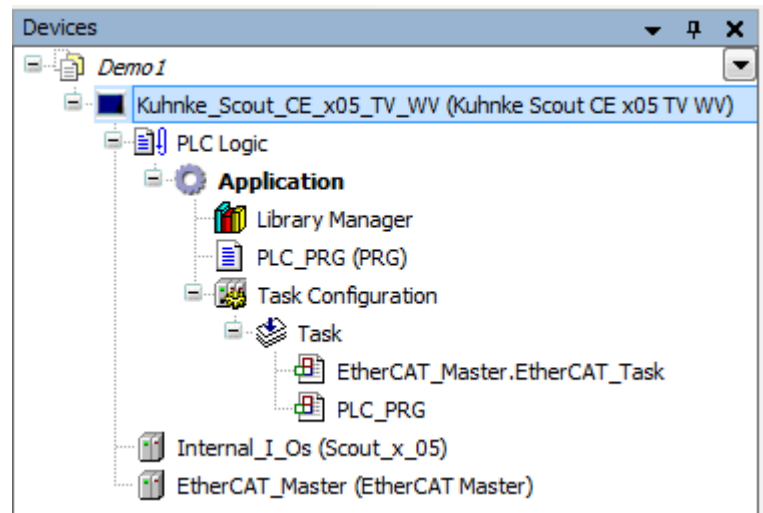

- 15th Go to the settings of the EtherCAT master and choose or enter the correct Ethernet interface:
 EtherCAT NIC Einstellungen (EtherCAT NIC settings) → Netzwerk durch Namen auswählen (Select Network by Name), name of network)

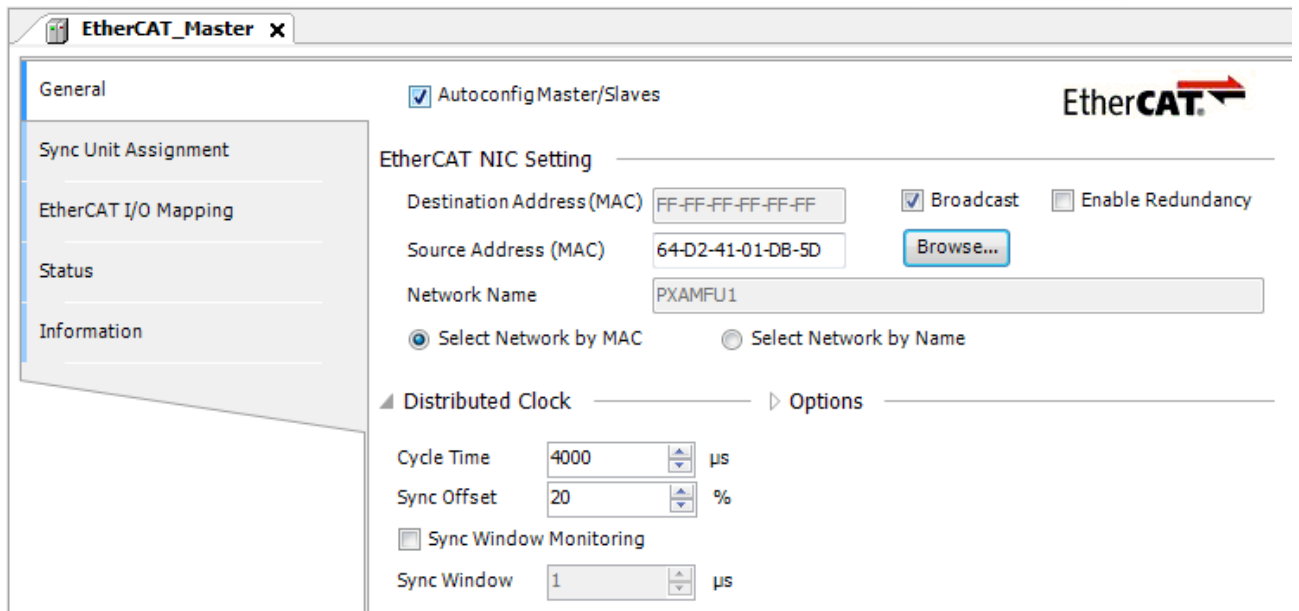

- 16th Add EtherCAT devices either manually or by searching EtherCAT.

To add EtherCAT devices manually

You can now add bus coupler(s), the Safety PLC, safety modules and other EtherCAT modules as seen by the standard PLC:

- 1st Right-click on "**EtherCAT_Master -> Gerät anhängen...**" (EtherCAT Master -> Add Device).
- 2nd Choose the devices.

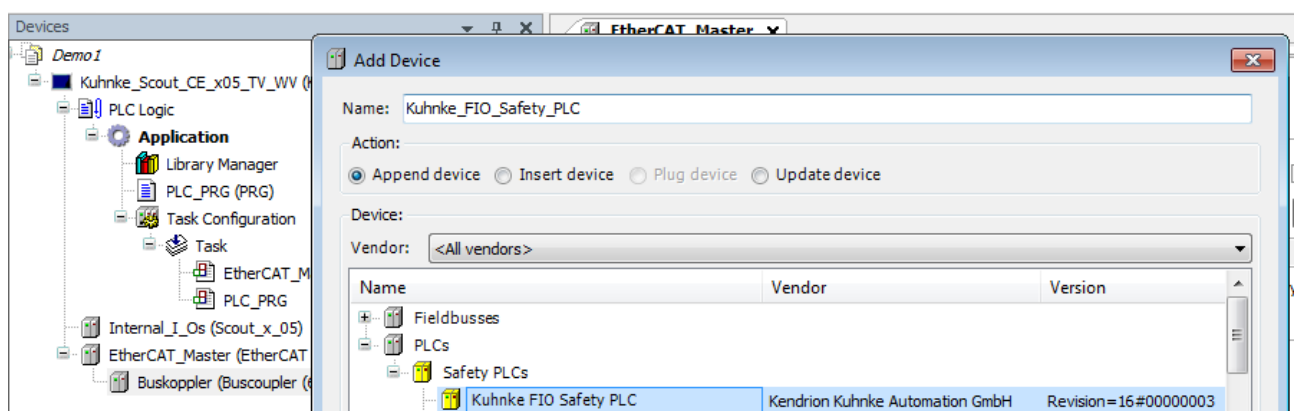
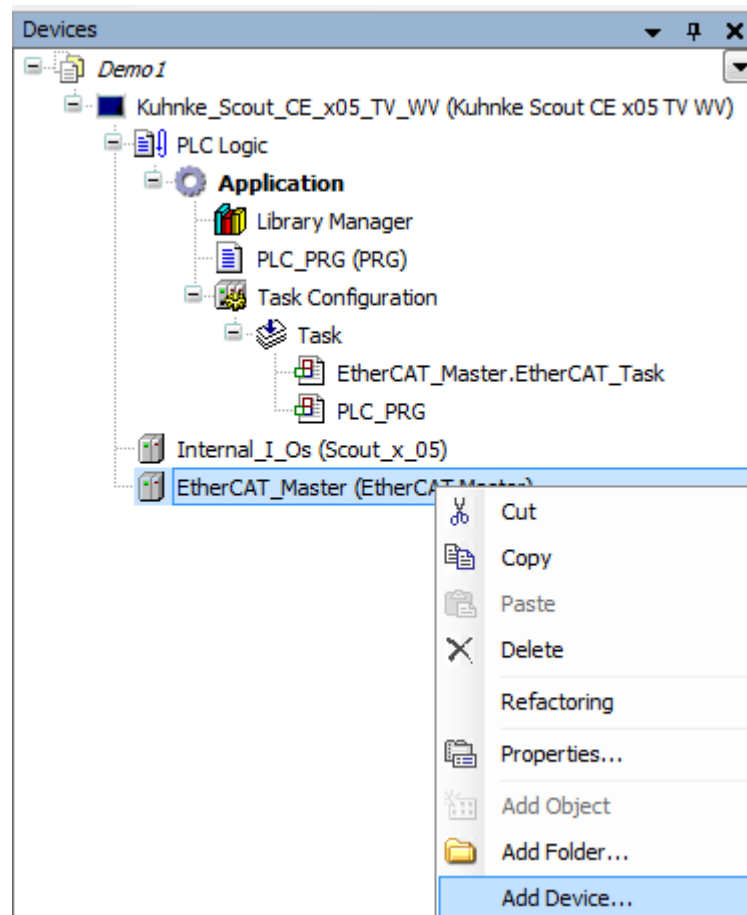

To add devices by searching EtherCAT

There is a more convenient way of adding modules than to pick them manually.

Available EtherCAT devices can be searched for automatically and added to the project. Before you can do so, check that the standard PLC hosts an executable and compilable application featuring an EtherCAT master. Also, all further modules you need have to be connected.

- 1st Right-click on "**Application-> Einloggen**" (Application -> Log On) to log on to the standard PLC.
- 2nd Load the application to the PLC.
- 3rd Right-click on **EtherCAT_Master -> Geräte suchen...** (EtherCAT Master -> Find Devices) to display a search dialog.

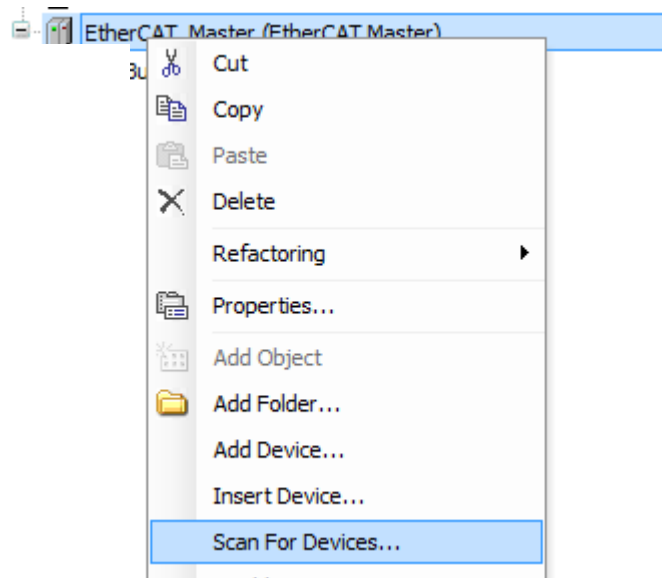

After the search, the dialog lists all devices found on the EtherCAT network.

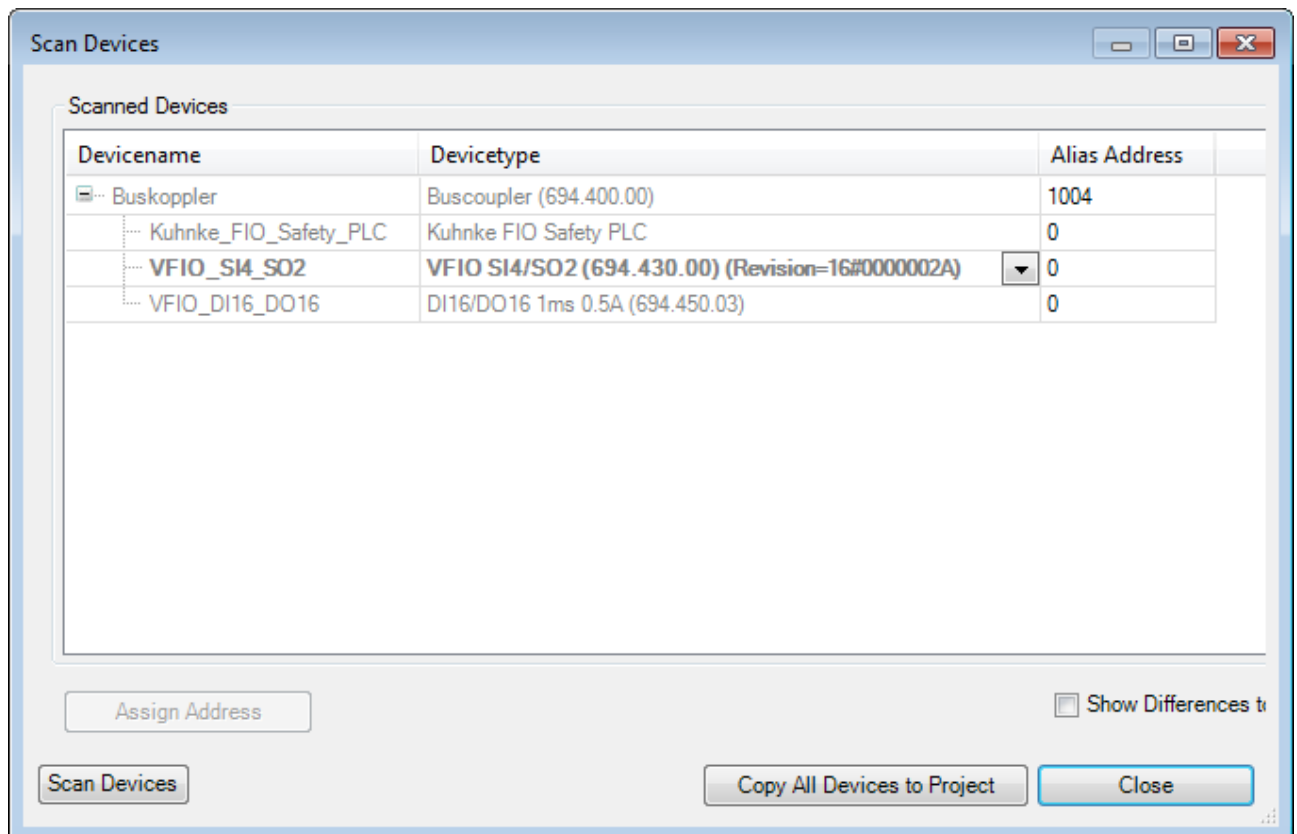

4th Click on "**Alle Geräte ins Projekt kopieren**" (Copy All Devices to the Project) to automatically append all devices below the EtherCAT master.

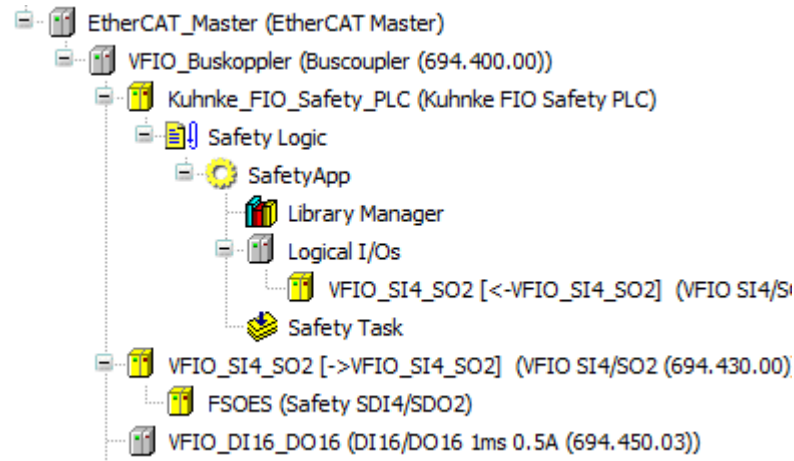

The safety application is in the EtherCAT module of the Safety PLC. The programming system treats the Safety PLC like a "normal" standard PLC (set active application, log on, log off).

i The CODESYS Safety manual explains how to create the safety application.

By default, a newly created empty safety project will have a user administration. This will normally be a user called "Owner" with no password assigned. A user must authenticate before changes made to a safety application become effective.

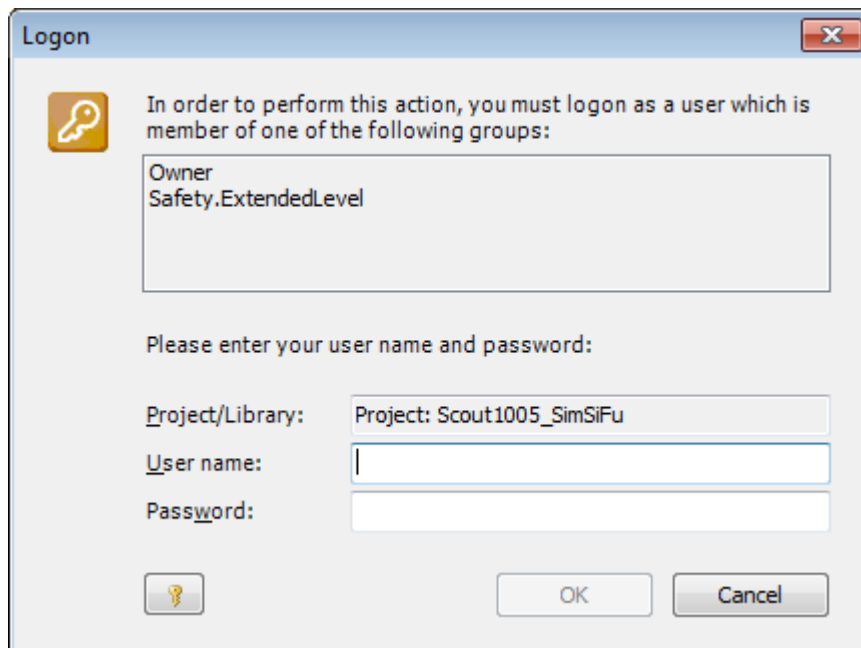

i Safety devices and safety applications should generally be protected by passwords against unauthorized access.

6.4.4 Safety PLC - Logging on and Downloading an Application

Before connecting to the Safety PLC, verify that the standard PLC has an EtherCAT master with a correct EtherCAT configuration and that the configuration has been started to ensure that the EtherCAT master is running properly.

- 1st Log on and right-click on "**SafetyApp**" -> "**Aktive Applikation**" (SafetyApp -> Active Application) and make the standard PLC the active application.

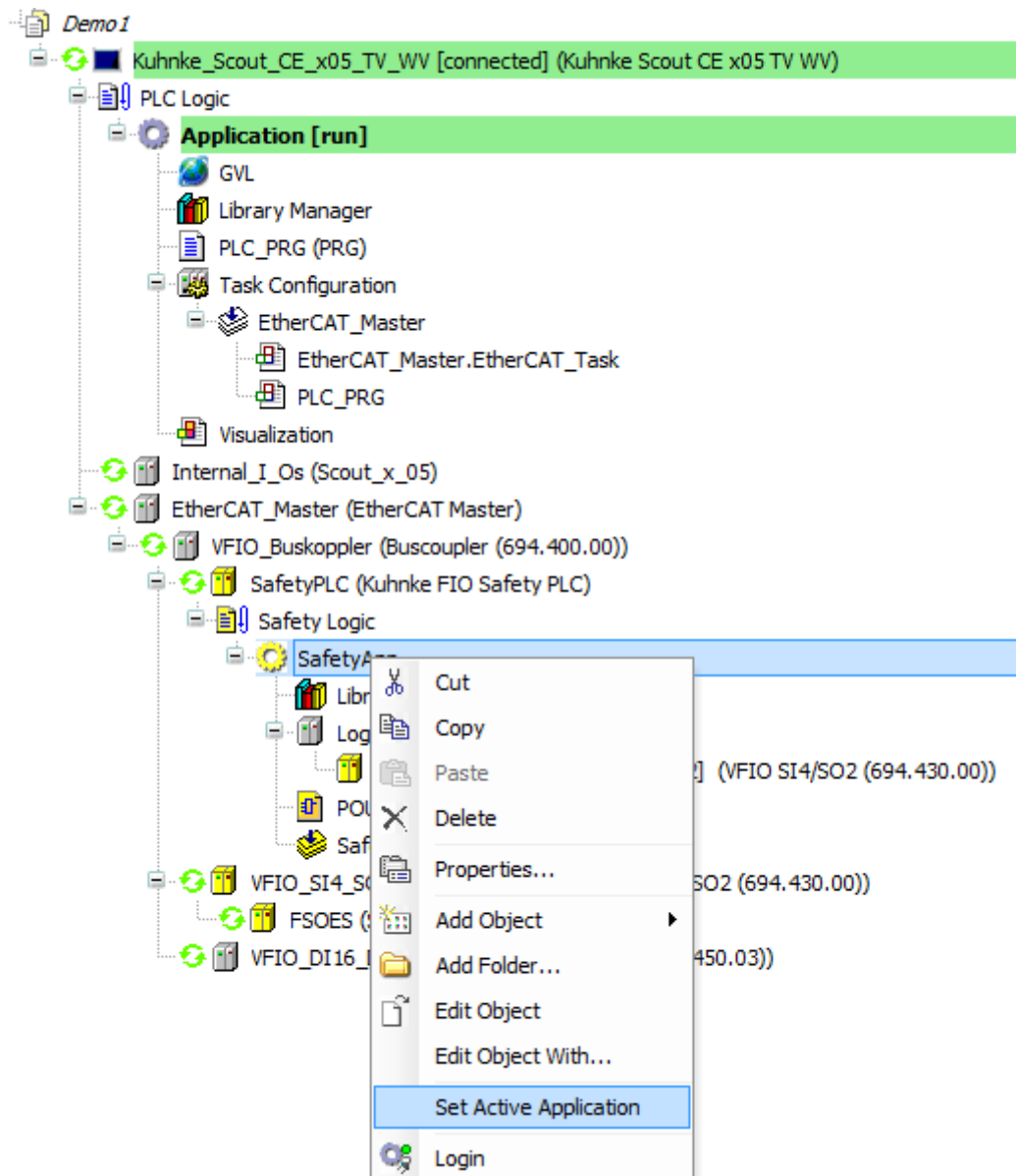

- 2nd Right-click on "**SafetyApp**" -> "**Einloggen**" (SafetyApp -> Log On) to log on to the Safety PLC.
- 3rd Load the application to the PLC.

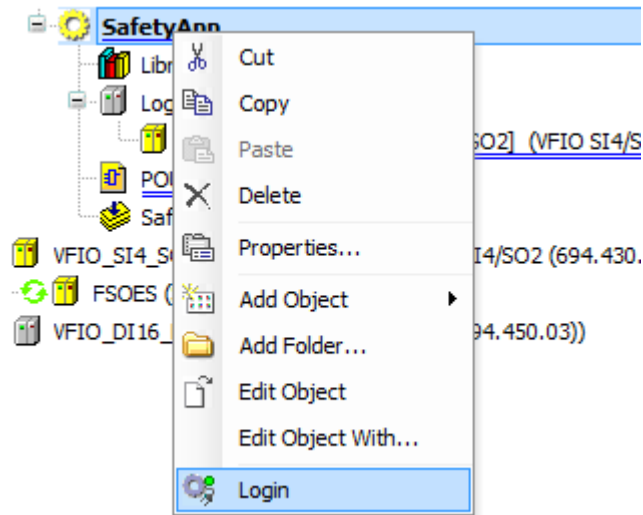

When logging on, you will be prompted for the Safety PLC's serial number. This is to avoid changing the Safety PLC and the application it hosts by mistake.

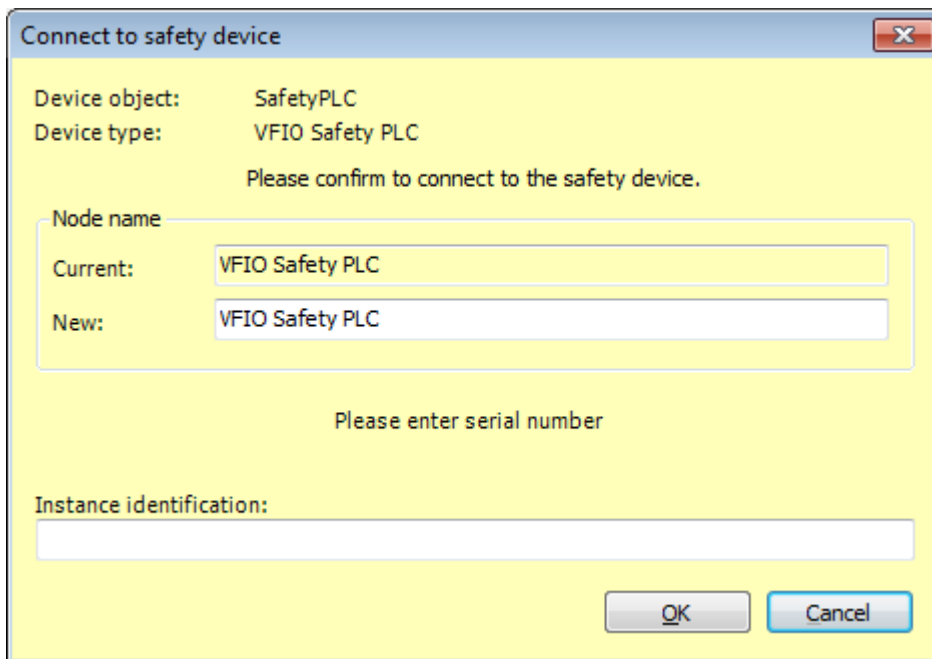

4th Right-click on "SafetyApp" -> **Start** to start the application.

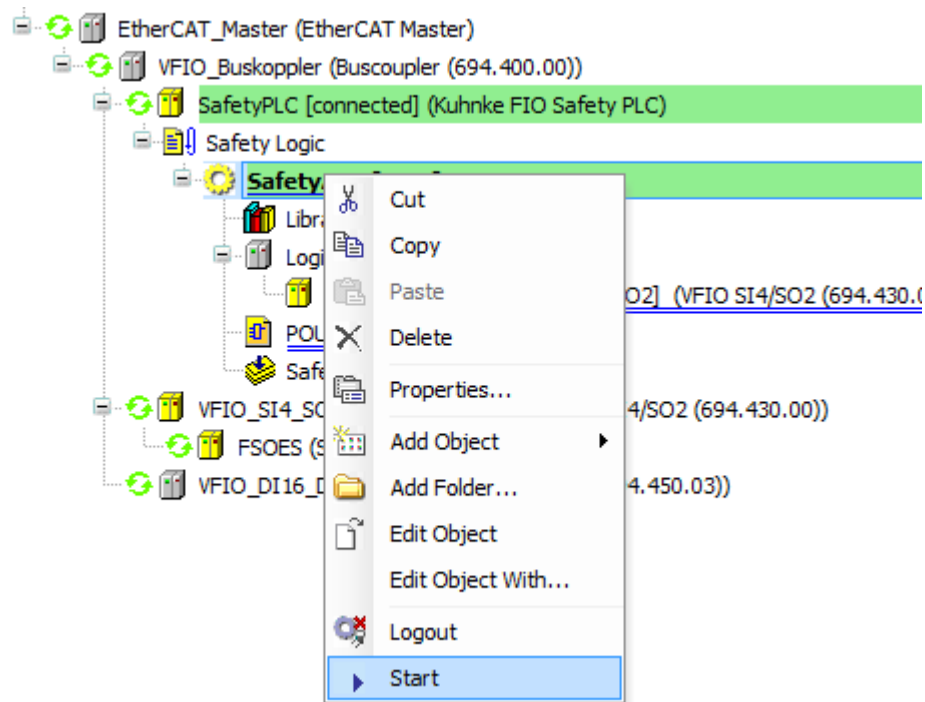

6.4.5 Safety PLC – FSoE (Safety over EtherCAT)

The Safety PLC uses FSoE (Safety over EtherCAT) to communicate with other safety modules. In this setup, the Safety PLC is the FSoE master, while the other safety modules are FSoE slaves. The master uses a unique ID to address the FSoE slaves. This will only work if the FSoE slave ID is unique within the EtherCAT network and has been added to both the master's and slave module's configuration. (Refer to the user guide of the slave module concerned to learn how to set the module's FSoE ID)

6.4.6 Setting the FSoE Slave IDs in the Safety PLC

Run CODESYS Safety to configure the FSoE (Safety over EtherCAT) slave modules in the Safety PLC.

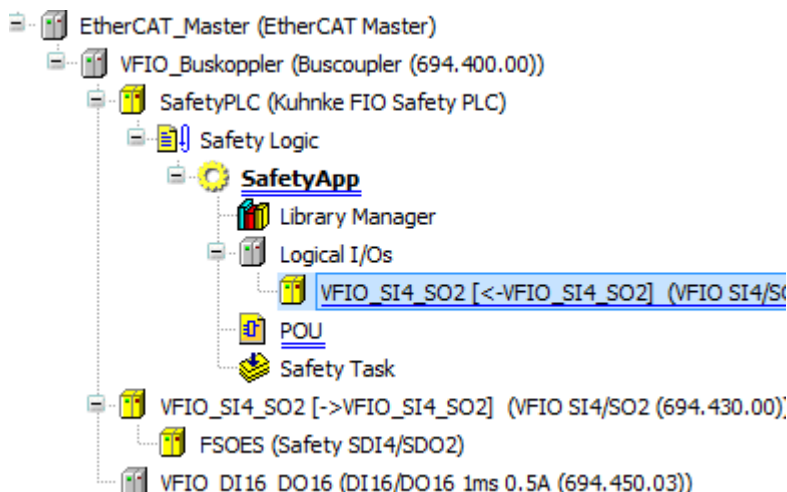

To configure the FSoE slave modules, go to the Safety PLC and find the "Logical I/Os" entry under "SafetyApp". This is where the system automatically adds the slave modules and where you can adapt them manually.

Enter the FSoE slave's configuration in the associated Configuration dialog by assigning a unique FSoE address and Connection ID to the module.

VFIO_S14_S02 x							
Safe configuration	In Work						
I/O mapping	<table border="1"> <thead> <tr> <th>Name</th> <th>Value</th> </tr> </thead> <tbody> <tr> <td>FSoE address</td> <td>4</td> </tr> <tr> <td>Connection ID</td> <td>4</td> </tr> </tbody> </table>	Name	Value	FSoE address	4	Connection ID	4
Name	Value						
FSoE address	4						
Connection ID	4						
Information							

6.5 Validation of Safety Functions

After completing the installation and setting up the safety application, the latter must be checked for proper operation within the overall system.

DANGER

Validation of Safety Functions!

The implementation and operation of safety applications within the overall system must be checked.

- ▶ Validation of the complete system according to the CODESYS Safety User Manual

6.6 Diagnosis

6.6.1 Self-test

When system voltage is supplied to the Safety PLC, it initially runs a complete system test. Only if this system test is passed will the module be able to operate and first of all change to its "fail-safe" state.

This state is indicated by LED "Safe Status" lighting up red.

The fail-safe state of the Safety PLC will be retained until the required internal tests have been passed.

After the self-test, the Safety PLC will start the safety application from its memory. This defines as the safe functional state which is indicated by LED "Safe Status" lighting up green.

The module will retain its fail-safe state if it fails to qualify for the safe state, e.g. because of errors in the application's module setup.

In normal op mode, the system test will be repeated as a cyclic background process. Any errors encountered will again provoke the fail-safe state and an entry in the CODESYS log.

6.6.2 Safety PLC Module Errors

The cyclic self-tests performed in compliance with the standards listed in the certificate will discover all errors in due time and change the module state to "fail-safe".

This is indicated by LED "Safe Status" lighting up red (see section 5.3 Status LEDs).



The status LEDs are not safety-related displays. That The status display via the LEDs must not be used alone as a safe indicator for the operating state of the module, etc.

DANGER

Use of devices in a fail-safe state

Subsequent faults may provoke a hazard.

- ▶ When an error occurs, have the actions taken required to find and remove the root cause and initiate any replacements, as appropriate.



In the case of serious module-internal errors of the Safety PLC, Kendrion Kuhnke Automation GmbH must be informed.

6.6.3 Temperature Faults

The module is designed for ambient temperatures between 0 °C and max. 55 °C and for being installed in a control cabinet. The Safety PLC features an internal temperature sensor. If the temperature is out of the specified range during operation, the state will change to "fail-safe". You cannot start the module if the temperature is out of the specified range.

CAUTION

Do not operate the Safety PLC module out of the specified range!

High or low temperature fault.

- ▶ Operate the module under the ambient conditions listed in section Technical Data only.

CAUTION

Use of the internal temperature sensor for safety applications is not permitted!

Non-safety-oriented temperature sensor.

- ▶ The internal temperature sensor must not be used for the realization of safety applications.

6.6.4 Error Handling and Logging

The Safety PLC's diagnostic LEDs indicate faults and errors according to the type of fault detected. The log screen of the relevant Safety PLC in the programming system will also list all error messages. Furthermore, the standard PLC can use COE objects (see object dictionary) to retrieve errors from specific registers of the Safety PLC.

6.7 Resetting / Acknowledging Errors

Safety PLC errors are distinguished as errors of the Safety PLC as such and errors occurring when communicating with sensors and actuators or the errors provoked by sensors and actuators.

Safety PLC errors can be acknowledged by restarting the PLC only. To restart the PLC, perform a PowerCycle (supply off/on) at the head module.

A loss of communication or errors of sensors or actuators provoke an error of the associated safety module. They can be detected via the safety application and acknowledged by the associated reset inputs of the modules (e.g. the FSoE master). During that time, the Safety PLC will retain its safe functional state.

PowerCycle

After removing the cause of an error, reset the Safety PLC by performing a PowerCycle at the head module (power off/on).

WARNING

Resetting / acknowledging may cause a dangerous state!

- ▶ Before acknowledging an error, verify that its cause has been removed professionally.
- ▶ Before acknowledging an error, verify that acknowledging it will not cause a dangerous machine state.
- ▶ At the machine or system planning stage, make sure that acknowledging an error must not be possible unless you have full view of the danger zone.

6.8 Maintenance / Servicing

6.8.1 General

Only qualified persons are allowed to work on the Safety PLC.

CAUTION

Unsafe and undefined machine state!

Destruction or malfunction of the Safety PLC.

- ▶ The module housing must not be opened.
- ▶ The module must not be repaired.
- ▶ Do not plug, mount, unplug or touch the connectors during operation!
- ▶ Turn off all power sources before working on the modules. This also applies to any peripherals connected such as encoders, programming devices with external power source, etc.
- ▶ Check that none of the ventilation slots is covered.

6.8.2 Servicing

For the specified service life, the Safety PLC needs neither servicing nor any other actions. For this reason, no spare parts are available.

During operation and storage, the Safety PLC must be protected against contamination, outside the usual contamination occurring in the defined ambient conditions. If the module has been exposed to unauthorized contamination, it must not be used, cleaned or further operated.

DANGER

Risk of injury caused by an unsafe and undefined machine state!

- ▶ You are not allowed to operate an inadmissibly contaminated module.
- ▶ Neither is cleaning the unit allowed.

6.9 Replacing a Safety PLC

CAUTION

Risk of injury caused by an unsafe and undefined machine state!

Risk of injury.

- ▶ Before replacing a Safety PLC module, turn off the power supply of the Safety PLC and the modules connected to it.
- ▶ After replacing a Safety PLC module and before restarting the machine or system, verify that the associated safety function is provided properly.

6.9.1 Replacement Procedure

Preparation

1st Verify that the new module meets the following requirements:

- Same type of device
- Same or higher version, see section 5.1 Labelling and Identification.

2nd Enable the safe system or machine state.

Kuhnke FIO Safety PLC (E 842 GB)

10. April 2024

3rd Turn off the power supply to the head module and the modules connected to it.

Remove the old module

4th Split up the line of FIO module, as necessary: press the unlock button of the adjacent module and push the two modules about 1 cm apart (refer to the instructions of the other module).

5th Push the module up and against the metal spring located on the underside of the rail guide (see section 6.1.6 To Take Down a Single Module).

6th Tip the module forward and away from the rail.

7th Pull the module down and out of the mounting rail.

Install and program the new module

8th Place the new module at the position in the line of module previously occupied by the old module (see section 6.1.3 To Snap on a Single Module).

9th Load the validated new safety application.

6.9.2 Restart

1st Verify that the machine or system is in a safe state and that there is nothing and nobody in the danger zone.

2nd Turn the power back on.

3rd After replacing the safety module, repeat the initial startup procedure (see section 6.3 Putting into Service).

4th Check all safety functions after replacing a module.

6.10 Durability

The Safety PLC modules have a design life of max. 20 years after the date of manufacture (see section 5.1 Labelling and Identification).

WARNING

Risk of injury caused by using a module beyond its design life!

- ▶ Remove the module from service when it is at the end of its design life at the latest (see section 6.10.3 Taking out of Service).

6.10.1 Repairs / Customer Service

You are not allowed to open a Safety PLC module or to attempt any other repairs. If you do, proper operation of the Safety PLC module is no longer warranted.



In case a module failure is potentially hazardous, return the module to the manufacturer where the fault will be identified.

Refer to section 9 Sales & Service for the manufacturer's address.

6.10.2 Warranty

The statutory period and conditions of warranty apply. Warranty expires if unauthorised attempts are made to repair the unit / product or any other intervention is performed.

6.10.3 Taking out of Service

The manufacturer of the machine or system specifies the procedure of taking the product out of service.

- ▶ Verify that used modules taken out of service are provided for further use as intended.
- ▶ Comply with the storage and transport requirements specified in the Technical Data section.

6.10.4 Disposal

- ▶ Dispose of the safety system in conformity with the applicable environmental regulations and make sure that the modules are not returned into circulation.
- ▶ Treat the packaging as recyclable paper and cardboard.

7 Safety function blocks

7.1 CODESYS safety libraries and their function blocks

The documentation for the CODESYS safety libraries and the blocks can be found in the installation directory after installing the safety package.

e.g. C:\Program Files (x86)\CODESYS 3.5.16.40\CODESYS\Documentation

7.2 Kendrion Kuhnke safety library and its function blocks

The CODESYS programming system checks the validity of all FB names that are called up in the programme logic of the safety programme during the login process that is used to log on to an S-PLC. If these are not reported as valid by the S-PLC, the login process is cancelled with an error message. A security-oriented program for an S-PLC can therefore only be executed on it or saved as a boot application if all the FBs called have been recognised as valid by the S-PLC beforehand.

It is therefore not possible to call an FB unknown to the S-PLC.

You can read out whether your SPLC supports the blocks via an object.

Support of Additional Funktion Blocks – 210Bh

Bezeichnung	Wert
Name	Additional Funktion Blocks
Index	210Bh
No. of Elements	0
Access	Read only
PDO Mapping	No
Value	"1" FBs are supported, "0" FBs are not supported

Library: KICS_Safety_Library

Identification of the components described here:

Name	Version	Safety CRC
SF01_ECM	1.0.0.0	16#0ECB_B7D4
SF01_Scale_Verify	1.0.0.0	16#823B_C19E

Can be read in the project, example SF01_ECM:

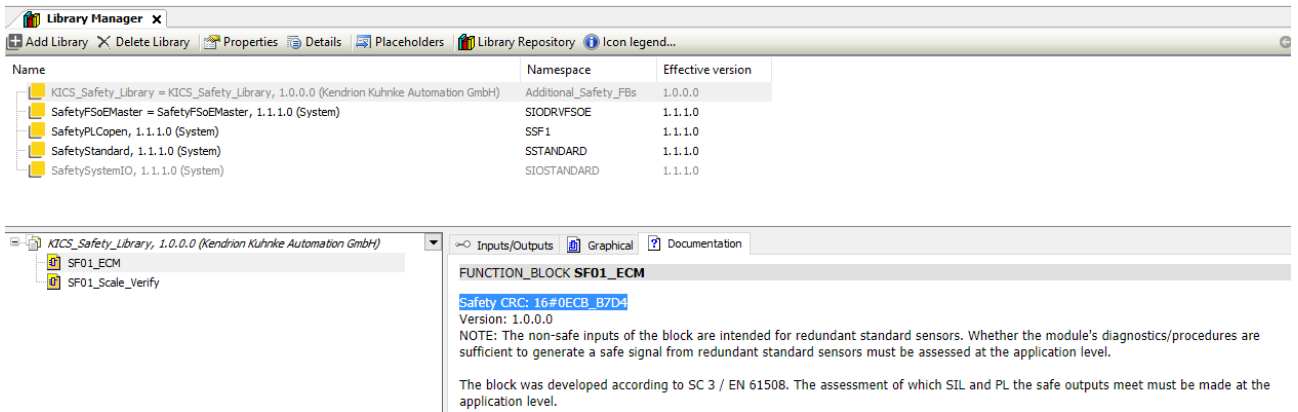

Or in the directly opened library, example SF01_Scale_Verify:

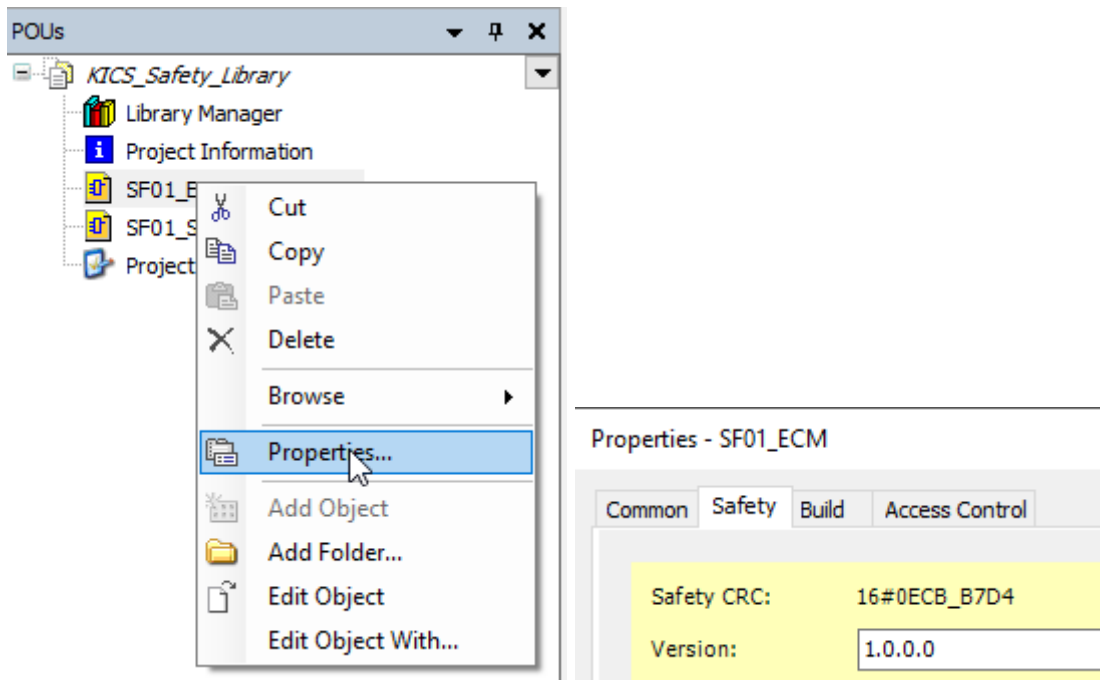

SF01_ECM - External Communication Monitoring

This FB monitors communication with another system (Profinet, Ethernet, RS485, etc.).

It can be checked whether communication is still taking place (timeout) or whether the content of a communicated data value (DINT) is correct.

The data structure contains the data shown in the Table

Nr.	Element of the data structure
1	Incremented telegram counter
2	Timestamp in milliseconds
3	ID for the data channel
4	PDO (data value) Typ: DINT
5	CRC 32

Table: Elements of the data structure to be transferred

This data structure is generated by the input module that outputs the data value and checked by this module in the safe control system. Each time the data value is generated, the input module increments the telegram counter and sets the time stamp to the current creation time. Each data source is assigned a unique ID to be parameterised, which must also be checked by the safe control system. The entire data structure is protected by means of a 32-bit CRC, which is defined by elements 1 - 4 from Table is calculated.

The CRC is formed with the following polynomial:

$$f(x) = x^{32} + x^{26} + x^{23} + x^{22} + x^{16} + x^{12} + x^{11} + x^{10} + x^8 + x^7 + x^5 + x^4 + x^2 + x + 1$$



This is the same polynomial as in CRC.c in the SafetyManager and can be calculated using tables. This enables the CRC value to be generated quickly.

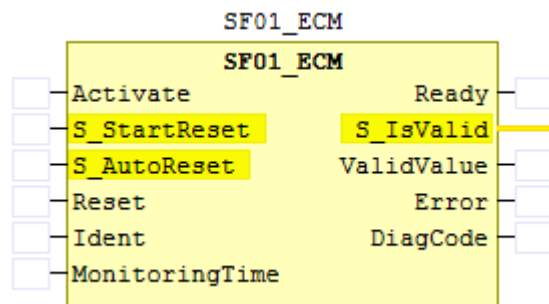

Figure: SF01_ECM

The SF01_ECM module receives the input data via an exchange device, which is connected directly to the ECM (EtherCAT master).

Variable	Mapping	Kanal	Adresse	Typ
udiCycleCout_ECM		CycleCount	%QD37	UDINT
tTimestamp_ECM		Timestamp	%QD38	TIME
uiSenderID_ECM		SenderID	%QW78	UINT
		Dummy	%QW79	UINT
dValue_ECM		Value	%QD40	DINT
udiCrc_ECM		CRC32	%QD41	UDINT

Figure: ECM device in CODESYS enviroment

The data is made available via the DataPDO in the SPLC.

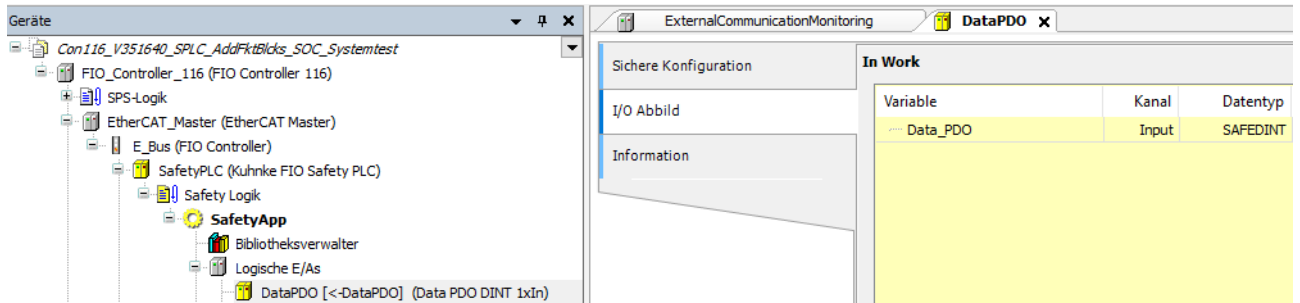

Figure: Logical I/O in SLPLC linked with SF01_ECM

The data packets received in this way are then checked in SF01_ECM and its outputs S_IsValid and ValidValue are set accordingly.

In this way, a cyclical data packet from the grey world is monitored in the safe control system.

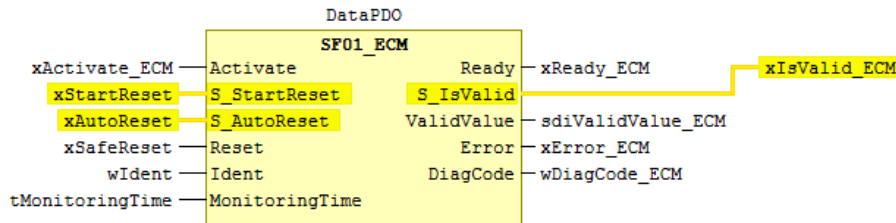

Figure: SF01_ECM FB in SPLC POU

VAR INPUT

Name	Datentyp	Initialwert	Beschreibung
Activate	BOOL	FALSE	General activation of the module
S_StartReset	SAFEBOOL	TRUE	Automatic reset of the monitoring when the system is started.
S_AutoReset	SAFEBOOL	FALSE	Automatic reset of the monitoring system while the system is running.
Reset	BOOL	FALSE	Manual reset of the monitoring
Ident	DINT	0	Clear identification of the communication connection
MonitoringTime	TIME	T#0ms	Timeout time for monitoring

CAUTION

The inputs S_StartReset and S_Auto-Reset should only be activated if it is ensured that no hazardous situation can arise when the S-PLC starts

VAR OUTPUT

Name	Datentyp	Initialwert	Beschreibung
Ready	BOOL	FALSE	Activation of the function block
S_IsValid	SAFEBOOL	FALSE	Flag to indicate the validity of the received data
ValidValue	DINT	0	Transmitted data value
Error	BOOL	FALSE	General error flag
DiagCode	WORD	0	Diagnostic code of the monitoring
Ready	BOOL	FALSE	Activation of the function block

Tabelle: Output parameters SF01_ECM

State diagram

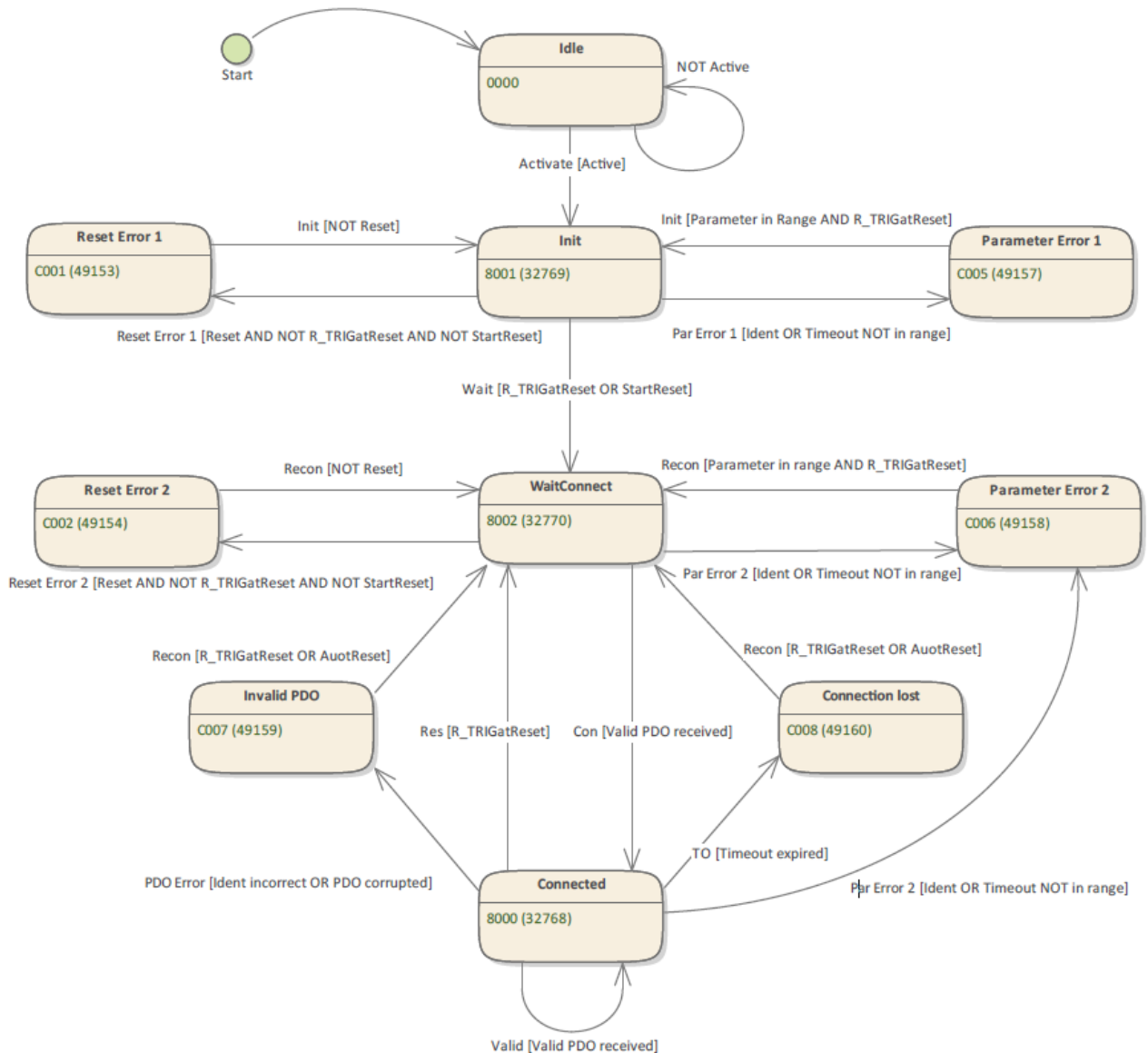

Note, Information

The state transition from any state to the Idle state due to the "NOT Active" condition is not shown for reasons of clarity.

Diagnostic-/State- codes

DiagCode	Statusname	Statusbeschreibung und Setzen des Ausgangs
16#0000	Idle	The module is not active (basic status) Activate := FALSE Ready := FALSE Error := FALSE S_IsValid := FALSE ValidValue := 0x0000
16#8001	Init	Module activation, Start-up-block is Activate := TRUE Ready := TRUE

DiagCode	Statusname	Statusbeschreibung und Setzen des Ausgangs
		Error := FALSE S_IsValid := FALSE ValidValue := 0x0000
16#8002	WaitConnect	FB is waiting for valid data Ready := TRUE Error := FALSE S_IsValid := FALSE ValidValue := 0x0000
16#8000	Connected	Module activ, final state without error Ready := TRUE Error := FALSE S_IsValid := TRUE ValidValue := <Act.Value>
16#C001	Reset Error 1	Rest status in the Init phase Ready:= TRUE Error := TRUE IsValid := FALSE ValidValue := 0x0000
16#C002	Reset Error 2	Rest status in the Wait Connect phase Ready:= TRUE Error := TRUE IsValid := FALSE ValidValue := 0x0000
16#C005	Parameter Error 1	Parameter error in the Init phase Ready:= TRUE Error := TRUE IsValid := FALSE ValidValue := 0x0000
16#C006	Parameter Error 2	Parameter error in the WaitConnect or Connect Phase Ready:= TRUE Error := TRUE IsValid := FALSE ValidValue := 0x0000
16#C007	Invalid PDO	PDO error in the Connect Phase Ready:= TRUE Error := TRUE IsValid := FALSE ValidValue := 0x0000
16#C008	Connection Lost	Missing PDO Transmission Ready:= TRUE Error := TRUE IsValid := FALSE ValidValue := 0x0000

SF01_Scale_Verify

This FB verifies a grey measured value (DINT) by comparing it with a second grey measured value. To do this, both measured values must come from 2 different signal sources and from 2 different communication paths.

If both values differ outside the time in Timeout by the value in Deviation, then S_isValid = False. Otherwise, S_isValid = True and the measured value can be further processed in S_ValidValue as a safe value. There is also a diagnostic code (DiagCode) and an error flag (Error).

The Table explains the function of the input parameters. In Table this is shown for the output parameters.

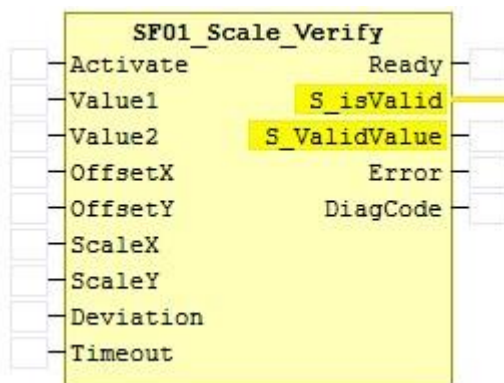

Figure: SF01_Scale_Verify



Note, Information

The input values Value 1 and Value 2 are not of type SAFEDINT, as these originate from single-channel sources and the measured values are therefore not verified. The module ensures proper verification and supplies a safe measured value of type SAFEDINT at the output for further processing. The module itself is implemented on a dual-channel safety PLC.

VAR INPUT

Name	Data type	Initial value	Description
Activate	BOOL	FALSE	General activation of the module
Value 1	DINT	0	Measured value to be verified 1
Value 2	DINT	0	Measured value to be scaled and used for verification 2
Offset x	DINT	0	Counter of the offset for scaling
Offset y	DINT	1	Denominator of the offset for scaling
Scale x	DINT	1	Numerator of the scaling factor
Scale y	DINT	1	Denominator of the scaling factor
Deviation	DWORD	0	Maximum permissible difference between measured value 1 (Value 1) and measured value 2 (Value 2)
Timeout	TIME	T#0ms	Maximum permissible time that measured value 1 and 2 may differ

Table: Input parameter SF01_Scale_Verify

VAR OUTPUT

Name	Data type	Initial value	Description
Ready	BOOL	FALSE	TRUE: Calculation and verification is complete
Error	BOOL	FALSE	General error flag
DiagCode	WORD	0	State code in the state machine
IsValid	SAFEBOOL	FALSE	Signal for validity of the measured output value (S_ValidValue)
S_ValidValue	SAFEDINT	0	Verified measured value 1

Table: Output parameter SF01_Scale_Verify

State diagram

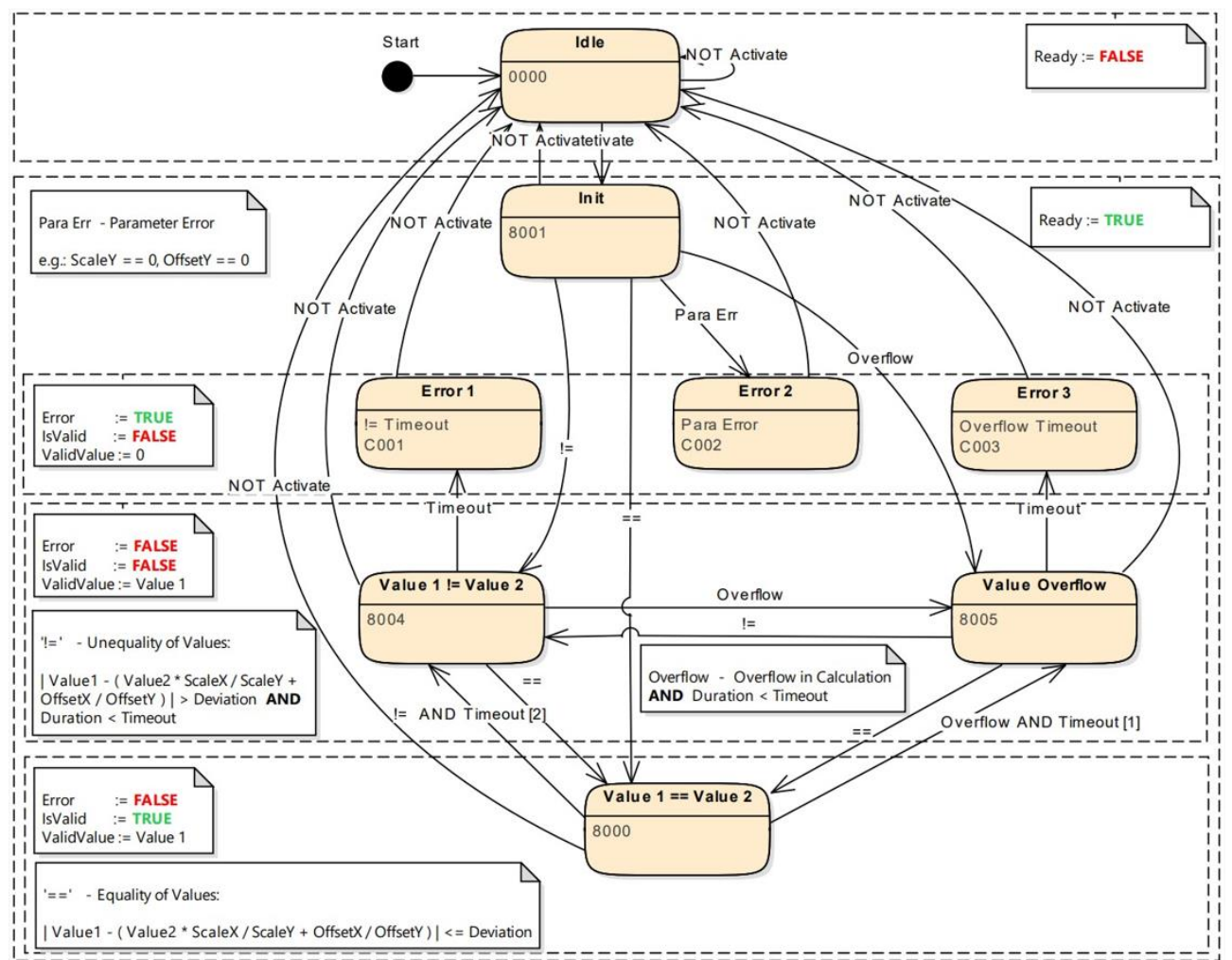

Diagnostic-/State- codes

DiagCode	Status name	Status description and setting the output
16#0000	Idle	The module is not active (basic status) Activate := FALSE Ready := FALSE
16#8001	Init	Block activation Start-up block is active. Activate required. Activate := TRUE Ready := TRUE
16#8000	Value1 == Value2	Module active, final state without error Error := FALSE IsValid := TRUE S_ValidValue := Value1
16#8004	Value1 <> Value2 (!=)	Value1 <> Value2 Zulässige Ungleichheit (Differenz von Messwert 1 und 2 <= Deviation) innerhalb der Zeitüberwachung (<Timeout) Error := FALSE IsValid := FALSE S_ValidValue := Value1
16#8005	Value Overflow	Value overflow Zulässige Bereichsüberschreitung von Messwert 2 innerhalb der Zeitüberwachung (<Timeout) Error := FALSE IsValid := FALSE S_ValidValue := Value1
16#C001	Error1 - Timeout	Time monitoring with the value inequality expired Error := TRUE IsValid := FALSE S_ValidValue := 0
16#C002	Error2 – Para Error	Parameter error Error := TRUE IsValid := FALSE S_ValidValue := 0
16#C003	Error3 – Overflow Timeout	Time monitoring with overrange of measured value 2 Error := TRUE IsValid := FALSE S_ValidValue := 0

8 Appendix

8.1 Safety Ratings of the Safety PLC

The table below lists the safety ratings of the Safety PLC. All components involved in the safety function must be taken into account in order to assess whether the desired safety level is achieved.

Designation	Value	
Highest safety integrity level to EN 62061:2010	SIL3	
Highest safety integrity level to IEC 61508:2010	SIL3	
Highest performance level to EN ISO 13849-1:2015	Cat. 4/PL e	
Hardware fault tolerance (HFT) (IEC 61508:2010/EN ISO 13849-1:2015)	1 (a fault of the application need not cause the safeguard to fail)	
	Ambient temp. 25 °C	Ambient temp. 55 °C
Probability of failure on demand (PFD _{avg}), proof test interval: 20 years (IEC 61508:2010)	2.57 * 10 ⁻⁵ (2.57% of entire PFD _{avg} at 10 ⁻³ bei SIL3)	2.99 * 10 ⁻⁵ (2.99% of entire PFD _{avg} von 10 ⁻³ at SIL3)
Probability of failure per hour (PFH _d), proof test interval: 20 years (IEC 61508:2010)	3.04 * 10 ⁻¹⁰ (0.3 % der gesamten PFH at 10 ⁻⁷ bei SIL3)	3.55 * 10 ⁻¹⁰ 1/h (0.36 % der gesamten PFH at 10 ⁻⁷ bei SIL3)
Diagnostic coverage (DC) to EN ISO 13849-1:2015	97.24 % (Is rounded to 99% according to EN ISO 13849-1: 2015)	96.9 % (Is rounded to 99% according to EN ISO 13849-1: 2015)
Safe failure fraction (SFF)	98.6 %	98.49 %
MTTFD to EN ISO 13849-1:2015	225 years	221 years

8.2 Safety Ratings of the safety function blocks

Designation	Value
Highest performance level to EN ISO 13849-1:2015	PL d

i The non-safe inputs of the function blocks are intended for (e.g. redundant) standard values. Whether the diagnostics of the function blocks are sufficient to generate safe values from the standard values must be assessed depending on the respective application.

The module was developed in accordance with SC 3 / EN 61508. The evaluation of SIL and PL, which the safety outputs fulfill, must be carried out at the application level.

8.3 Communication Objects

8.3.1 Device Type 1000_h

Designation	Value
Name	Device Type
Index	1000h
Object Code	VARIABLE
No. of Elements	0
Data Type	UNSIGNED32
Access	Read only
PDO Mapping	No
Value Range	Set
Default Value	89130000h

8.3.2 Error Register 1001_h

Designation	Value
Name	Error Register
Index	1001h
Object Code	VARIABLE
No. of Elements	0
Data Type	UNSIGNED8
Access	Read only
PDO Mapping	No, TX-PDO
Default Value	00h

Bit analysis to CANopen DS301:

Bit7	Bit6	Bit5	Bit4	Bit3	Bit2	Bit1	Bit0
0x80	0x40	0x20	0x10	0x08	0x04	0x02	0x01
n.i.	n.i.	n.i.	n.i.	temperature error	voltage error	n.i.	other faults

8.3.3 Device Name 1008_h

Designation	Value
Name	Device Name
Index	1008h
Object Code	VARIABLE
No. of Elements	0
Data Type	VISIBLE_STRING
Access	Read only
PDO Mapping	no
Value Range	Set

Subindex 0 of this object contains the string length. Subindex 1 contains each of the characters. The character string has no terminating zero.

8.3.4 Hardware Version 1009_h

Designation	Value
Name	Manufacturer Hardware Version
Index	1009h
Object Code	VARIABLE
No. of Elements	0
Data Type	VISIBLE_STRING
Access	Read only
PDO Mapping	No
Value Range	Set
Default Value	12E3030 h (1.00)

8.3.5 Software Version 100A_h

Designation	Value
Name	Software Version
Index	100Ah
Object Code	VARIABLE
No. of Elements	0
Data Type	VISIBLE_STRING
Access	Read only
PDO Mapping	No
Value Range	Set
Default Value	1.2.0

8.3.6 CANopen 'Restore Default Parameters' obj. 1011_h

Designation	Value
Name	CANopen 'Restore Default Parameters' obj.
Index	1011h
Object Code	RECORD
No. of Elements	5

Designation	Value
Name	Number of entries
Subindex	00h
Data Type	UNSIGNED8
Access	Read only
PDO Mapping	No
Default Value	No default

Designation	Value
Name	Restore all parameters (not used)
Subindex	01h
Data Type	UNSIGNED32
PDO Mapping	No

Designation	Value
Name	Restore communication parameters (not used)
Subindex	02h
Data Type	UNSIGNED32
PDO Mapping	No

Designation	Value
Name	Restore application parameters (not used)
Subindex	03h
Data Type	UNSIGNED32
PDO Mapping	No

Designation	Value
Name	Restore file system (write 0x64616F6C; comes into effect on next power cycle; request will be cleared after 1 min if no power cycle occurs)
Subindex	04h
Data Type	UNSIGNED32
Access	Read / write
PDO Mapping	No

Designation	Value
Name	Delete Boot Application (write 0x64616F6C; comes into effect on next power cycle; request will be cleared after 1 min if no power cycle occurs)
Subindex	05h
Data Type	UNSIGNED32
Access	Read / write
PDO Mapping	No

8.3.7 Identity Object 1018h

Designation	Value
Name	Identity Object
Index	1018h
Object Code	RECORD
No. of Elements	4
Data Type	IDENTITY

Designation	Value
Name	Number of entries
Subindex	00h
Data Type	UNSIGNED8
Access	Read only
PDO Mapping	No
Default Value	4

Designation	Value
Name	Vendor ID
Subindex	01h
Data Type	UNSIGNED32
Access	Read only
PDO Mapping	No

Designation	Value
Name	Product Code
Subindex	02h
Data Type	UNSIGNED32
Access	Read only
PDO Mapping	No

Designation	Value
Name	Revision
Subindex	03h
Data Type	UNSIGNED32
Access	Read only
PDO Mapping	No

Designation	Value
Name	Serial Number
Subindex	04h
Data Type	UNSIGNED32
Access	Read only
PDO Mapping	No
Units	yyyy yy mmmm dddd nnnnnnnnnnnnnnnnn 6 bits 4 bits 5 bits 17 bits Year 2014 is coded as '0'.
Value Range	14 01 01 00001 (0x00420001) ... 77 12 31 99999 (0xFF3F869F)
Example	16052300001 □ 0x096E0001

The object contains details of the manufacturer, the product code and the revision and serial numbers.

8.3.8 Error Settings (Not Used) 10F1_h

Designation	Value
Name	Error Settings (Not Used)
Index	10F1 _h
No. of Elements	0
Access	Read only
PDO Mapping	No, TX-PDO

8.3.9 Sync Manager Type (Not Used) 1C00_h

Designation	Value
Name	Sync Manager Type (Not Used)
Index	1C00 _h
No. of Elements	0
Data Type	UNSIGNED8
Access	Read only
PDO Mapping	No

8.3.10 SM out Par (Not Used) 1C32_h

Designation	Value
Name	SM out Par (Not Used)
Index	1C32 _h
No. of Elements	0
Data Type	UNSIGNED8
Access	Read only
PDO Mapping	No

8.3.11 SM in Par (Not Used) 1C33_h

Designation	Value
Name	SM in Par (Not Used)
Index	1C33 _h
No. of Elements	0
Data Type	UNSIGNED8
Access	Read only
PDO Mapping	No

8.4 Manufacturer-specific Objects

8.4.1 MC 1: Reference Voltage [mV] 2000_h

Designation	Value
Name	MC 1: Reference Voltage [mV]
Index	2000h
Object Code	VARIABLE
No. of Elements	0
Data Type	UNSIGNED16
Access	Read only
PDO Mapping	No
Units	mV
Value Range	0 ... 65535
Default Value	No default value

8.4.2 MC 1: 5 V Supply Voltage [mV] 2002_h

Designation	Value
Name	MC 1: 5 V Supply Voltage [mV]
Index	2002h
Object Code	VARIABLE
No. of Elements	0
Data Type	UNSIGNED16
Access	Read only
PDO Mapping	No
Units	mV
Value Range	0 ... 65535
Default Value	No default value

8.4.3 MC 1: 3.3 V Supply Voltage [mV] 2003_h

This is the supply voltage of MC 2 measured by MC 1.

Designation	Value
Name	MC 1: 3.3 V Supply Voltage [mV]
Index	2003h
Object Code	VARIABLE
No. of Elements	0
Data Type	UNSIGNED16
Access	Read only
PDO Mapping	No
Units	mV
Value Range	0 ... 65535

Default Value	No default value
---------------	------------------

8.4.4 Temperature Sensor [0.01 °C] 2006h

Designation	Value
Name	Temperature Sensor [0.01 °C]
Index	2006h
Object Code	VARIABLE
No. of Elements	0
Data Type	UNSIGNED16
Access	Read
PDO Mapping	No
Units	0.01 °C
Value Range	0 ... 8000
Default Value	No default value

8.4.5 MC 1: Error Code 2007h

Designation	Value
Name	MC 1: Error Code
Index	2007h
Object Code	VARIABLE
No. of Elements	0
Data Type	UNSIGNED32
Access	Read
PDO Mapping	No

The table below explains every entry in object 2007h "Err.code".

Id	Hex	Explanation
0	0x0000	OK: No error
1	0x0001	HWT_PARAMETER_ERROR Hardware test parameter error
2	0x0002	HWT_INIT_ERROR Hardware test initialisation error
100	0x0064	HWT_MEM_MARCHC_ERROR Hardware test RAM check error
101	0x0065	HWT_MEM_GALPAT_ERROR Hardware test RAM check error
200	0x00C8	HWT_STACK_UNDERFLOW_ERROR Hardware test stack underflow
201	0x00C9	HWT_STACK_OVERFLOW_ERROR Hardware test stack overflow
300	0x012C	HWT_CPU_ERROR Hardware test CPU error
400	0x0190	WT_FW_ERROR

Id	Hex	Explanation
		Hardware test firmware error
500	0x01F4	HWT_FWINTERFACE_ERROR Hardware test firmware error
504	0x01F8	HWT_ADC_ERROR: Test handler: error in ADC value range checks Hardware test AD converter error
505	0x01F9	HWT_DMA_ERROR: Test handler: error in DMA check Hardware test DMA checksum error
506	0x01FA	HWT_CRC_ERROR: Test handler: error in CRC check Hardware test checksum error
507	0x01FB	HWT_TIMER_ERROR: Test handler: error in timer check Hardware test CPU timer error
508	0x01FC	HWT_CLOCK_ERROR: Test handler: error in clock signal check Hardware test CPU clock error
512	0x0200	TIMEOUT_ERR: I2C communication timeout detected Software timeout detected
513	0x0201	OUT_OF_RANGE_ERR: Parameter or value out of allowed range. Parameter range error
514	0x0202	OVERWRITE_ERR: Register buffer data overwrite occurred. Data overflow
516	0x0204	PRG_CNTRL_ERR: Program sequence control detected error. Programme sequence error
517	0x0205	“Soft-Error” detected Software error
528	0x0210	INIT_ERROR: Initialization error Initialisation error
592	0x0250	ASSERT_TRUE_ERR: Assertion for expression yields "true" failed. Asserting "true" failed
593	0x0251	ASSERT_NOT_NULL_ERR: Assertion for unequal to NULL failed. Asserting unequal to "NULL" failed
594	0x0252	ASSERT_GE_ERR: Assertion for ">=" comparison failed. Asserting ">=" failed
595	0x0253	ASSERT_GT_ERR: Assertion for ">" comparison failed. Asserting ">" failed
596	0x0254	ASSERT_LE_ERR: Assertion for "<=" comparison failed. Asserting "<=" failed
597	0x0255	ASSERT_LT_ERR: Assertion for "<" comparison failed. Asserting "<" failed
598	0x0256	ASSERT_NE_ERR: Assertion for "<>" comparison failed. Asserting "<>" failed
599	0x0257	ASSERT_EQ_ERR: Assertion for "=" comparison failed. Asserting "=" failed
600	0x0258	ASSERT_FALSE_ERR: Assertion for expression yields "false" failed. Asserting "false" failed
672	0x02A0	MRAM not initialized
673	0x02A1	MRAM_READ_ERR: MRAM read error.
676	0x02A4	MRAM_CORRUPT_PAGE_SIZE: Invalid MRAM page size.
677	0x02A5	MRAM_CRC_ERR: MRAM data CRC check failed. MRAM checksum error (CRC error)
688	0x02B0	LZS logging not yet initialized.

Id	Hex	Explanation
689	0x02B1	LZS logging initialized.
692	0x02B4	LZS world time timer initialized.
696	0x02B8	Request file system reset.
697	0x02B9	Request deleting boot app from file system.
698	0x02BA	Boot app deleted from file system.
699	0x02BB	Reset of file system activated.
700	0x02BC	System request cancelled due to timeout.
768	0x0300	RESET_LOW_POWER: Reset due to low power supply.
769	0x0301	RESET_WINDOW_WD: Reset due to window watchdog.
770	0x0302	RESET_INDEPENDENT_WD: Reset due to independent watchdog. Reset by watchdog timer
771	0x0303	RESET_SW: Reset due to software reset.
772	0x0304	RESET_POWER_ON_DOWN: Reset due to power up or down.
773	0x0305	RESET_NMI: Reset due to non-maskable interrupt.
774	0x0306	RESET_BROWNOUT: Reset due to brown out detection. Reset by low CPU voltage
775	0x0307	RESET_NO_REASON: Reset for unknown reason.
778	0x310	Reset for invalid reason
1024	0x0400	ADC_REF_LOW: AD converter reference voltage too low.
1025	0x0401	ADC_REF_HIGH: AD converter reference voltage too high.
1028	0x0404	ADC_5V_LOW: 5 V supply voltage too low. (ErrReg: 4) 4)
1029	0x0405	ADC_5V_HIGH: 5 V supply voltage too high. (ErrReg: 4) Upper limit of internal 5 V supply exceeded
1030	0x0406	ADC_3_3V_LOW: 3.3 V supply voltage too low. Power below internal 3.3 V limit
1031	0x0407	ADC_3_3V_HIGH: 3,3 V supply voltage too high. Upper limit of internal 3.3 V supply exceeded
1032	0x0408	ADC_TEMP_LOW: On-chip temperature too low. (ErrReg: 8) Ambient temperature too low
1033	0x0409	ADC_TEMP_HIGH: On-chip temperature too high. (ErrReg: 8) Ambient temperature too high
1034	0x040A	ADC_CURR_HIGH: Total output current too high. (ErrReg: 2)
1036	0x040C	Temperature at warning limit
1037	0x040D	Data value not yet available
1280	0x0500	LINE_TIMEOUT: Invalid sync line level from base board Sync line level monitoring timeout
1282	0x0502	TIMEOUTTIMERERR: Timeout timer error occurred
1283	0x0503	HW_REVISION_ERROR: Invalid HW revision detected (the SW currently running is not designed for this HW revision) Wrong hardware / PCB revision (current software not intended for this HW revision)
1664	0x0680	MC1_NOTREADY: MC1 has not yet initiated communication with MC3
2048	0x0800	BCOM_NOTREADY: Base board communication not ready / operational
2049	0x0801	BCOM_BUSY: Base board communication is busy
2050	0x0802	BCOM_NONEWDATA: No new data received from base board Communication with base board – no new data received

Id	Hex	Explanation
2051	0x0803	BCOM_CRCERR: Base board communication CRC error detected Communication with base board – CRC error
2052	0x0804	BCOM_BITERR: Communication with base board – shifted bits detected Communication with base board – shifted bits
2304	0x0900	XCOM_NOTREADY: Communication with safety partner microcontroller (MC) not ready / operational
2305	0x0901	XCOM_BUSY: Safety partner MC communication is busy
2306	0x0902	XCOM_NONEWDATA: Communication with safety partner MC – no new data received
2307	0x0903	XCOM_CRCERR: Safety partner communication CRC error detected Communication with safety partner MC – CRC error
2336	0x0920	3S RTS background communication with safety partner MC not operational
2337	0x0921	3S RTS background communication with safety partner is busy
2338	0x0922	3S RTS background communication has not yet received new data from safety partner MC
2339	0x0923	3S RTS background safety partner communication CRC error detected
2340	0x0924	BGCOM_QUEUEERR: 3S RTS background safety partner communication queue error detected
2352	0x0930	3S RTS VM-to-safety partner MC communication not operational yet
2353	0x0931	3S RTS VM-to-safety partner communication is busy
2354	0x0932	3S RTS VM communication has not received new data from safety partner MC
2355	0x0933	3S RTS VM-to-safety partner communication CRC error detected
2560	0x0A00	I2C_TIMEOUT: I2C communication timeout detected
2561	0x0A01	I2C_BUSY: I2C bus is busy
2976	0x0BA0	FSoE Master finished initialization
2977	0x0BA1	FSoE Master is shutting down
3329	0x0D01	MC1_ID_INVALID: Identifying MC 1 failed
3330	0x0D02	MC2_ID_INVALID: Identifying MC 2 failed
3331	0x0D03	MC3_ID_INVALID: Identifying MC 3 failed
3841	0x0F01	FLASH_TIMEOUT: FLASH write operation timeout
3842	0x0F02	FLASH_LOCKED: FLASH write operation failed because "LOCK" bit could not be reset
3851	0x0F0B	FLASH_BUSY: FLASH operation busy Flash programming sequence error
3854	0x0F0E	FLASH_ERROR: FLASH operation error Programming the FLASH memory failed

8.4.6 MC 1: Error Line 2008_h

Designation	Value
Name	Err.line
Index	2008h
Object Code	VARIABLE
No. of Elements	0
Data Type	UNSIGNED16

Access	Read
PDO Mapping	No

8.4.7 MC 1: Error Module 2009_h

Designation	Value
Name	Error Module
Index	2009 _h
Object Code	VARIABLE
No. of Elements	0
Data Type	UNSIGNED8
Access	Read
PDO Mapping	No

The table below explains every entry in object 2009_h "Err.module".

Id	Hex	Explanation
0	0x00	OBJ_UNKNOWN_ID Error from module: unknown
4	0x04	OBJ_PRGCONTROLTASK_ID Error from module: CProgramControlTask.cpp
8	0x08	OBJ_SAFETYHAL_ID Error from module: CSafetyHal.cpp
12	0x0C	OBJ_MAINTASK_ID Error from module: CMainTask.cpp
16	0x10	OBJ_PRGCONTRLTASK_ID Error from module: CProgramControlTask.cpp
20	0x14	OBJ_SYNCSAFETYPARTNER_ID Error from module: CSyncSafetyPartner.cpp
24	0x18	OBJ_XCOM_ID Error from module: CXcom.cpp
28	0x1C	OBJ_BBCOM_ID Error from module: CBBCom.cpp
29	0x1D	OBJ_VMCOM_ID Error from module: CVMCom module
30	0x1E	OBJ_BGCOM_ID Error from module: CBGCom module
52	0x34	OBJ_HELPER_ID Error from module: CHelper.cpp
56	0x38	OBJ_SYNCLINE_ID Error from module: CSyncSafetyPartner.cpp - sync()
58	0x40	OBJ_TESTHANDLER_ID Error from module: CTestHandler.cpp
72	0x48	OBJ_DIAGNOSTIC_ID Error from module: CDiagnostic.cpp
74	0x50	OBJ_FSOEMASTER_ID Error from module: CHAL_FSoEMaster_Template.cpp
88	0x58	OBJ_INTHANDLER_ID

Id	Hex	Explanation
		Error from module: InterruptHandler.cpp
192	0xC0	OBJ_SPI_ID Error from module: CSpi.cpp
193	0xC1	OBJ_TIMER_ID Error from module: CTimer.cpp
194	0xC2	OBJ_BACKUPSRAM_ID Error from module: CBackupSRam.cpp
195	0xC3	OBJ_PWR_ID Error from module: CPwr.cpp
196	0xC4	OBJ_RCC_ID Error from module: CRcc.cpp
197	0xC5	OBJ_GPIO_ID Error from module: CGpio.cpp
198	0xC6	OBJ_DMASTREAM_ID Error from module: CDmaStream.cpp
199	0xC7	OBJ_ADC_ID Error from module: CAdc.cpp
200	0xC8	OBJ_WD_ID Error from module: CWatchdog.cpp
201	0xC9	OBJ_FLASH_ID Error from module: CFlash.cpp
202	0xCA	OBJ_CRC_ID Error from module: CCrc.cpp
203	0xCB	OBJ_I2C_ID Error from module: CI2c.cpp
208	0xD0	OBJ_APPIF_ID Error from module: CECatApplInterface.cpp

8.4.8 MC 1: Error Class 200A_h

Designation	Value
Name	Err.class
Index	200Ah
Object Code	VARIABLE
No. of Elements	0
Data Type	UNSIGNED8
Access	Read
PDO Mapping	No

The table below explains every entry in object 200Ah "Err.class".

Id	Explanation
0	No error
1	Serious or synchronization error
2	Internal communication error
3	I/O error

4 TestHandler error

8.4.9 MC 1: System Uptime [s] 200Ch

Designation	Value
Name	System Uptime [s]
Index	200Ch
Object Code	VARIABLE
No. of Elements	0
Data Type	UNSIGNED32
Access	Read
PDO Mapping	No
Units	s
Default Value	No default value

8.4.10 Read / Write World Time [s] (LOG Time) 200Dh

Designation	Value
Name	Read / write world time [s] (GMT, UTC)
Index	200Dh
Object Code	VARIABLE
No. of Elements	0
Data Type	UNSIGNED32
Access	Read / Write
PDO Mapping	No
Units	s
Default Value	No default value

8.4.11 MC 3: 3.3 V Supply Voltage [mV] 2013h

Designation	Value
Name	MC 3: 3.3 V Supply Voltage [mV]
Index	2013h
Object Code	VARIABLE
No. of Elements	0
Data Type	UNSIGNED32
Access	Read
PDO Mapping	No
Units	mV
Default Value	No default value

8.4.12 Temperature Warning 2016h

Designation	Value
-------------	-------

Name	Temperature warning
Index	2016h
Object Code	VARIABLE
No. of Elements	0
Data Type	UNSIGNED8
Access	Read
PDO Mapping	No
Value	0°C – 55°C = 0; <0°C or >55°C = 1
Default Value	No default value

8.4.13 MC 1: LZS ComponentId 2017_h

Designation	Value
Name	MC 1: LZS ComponentId
Index	2017h
Object Code	VARIABLE
No. of Elements	0
Data Type	UNSIGNED32
Access	Read
PDO Mapping	No
Default Value	No default value

8.4.14 MC 1: LZS FileId 2018_h

Designation	Value
Name	MC 1: LZS FileId
Index	2018h
Object Code	VARIABLE
No. of Elements	0
Data Type	UNSIGNED32
Access	Read
PDO Mapping	No
Default Value	No default value

8.4.15 MC 1: LZS Line 2019_h

Designation	Value
Name	MC 1: LZS Line
Index	2019h
Object Code	VARIABLE
No. of Elements	0
Data Type	UNSIGNED32
Access	Read

PDO Mapping	No
Default Value	No default value

8.4.16 MC 1: Read Number of CORA Test Cycles 201A_h

Designation	Value
Name	MC 1: Read Number of CORA Test Cycles
Index	201Ah
Object Code	VARIABLE
No. of Elements	0
Data Type	UNSIGNED32
Access	Read
PDO Mapping	No
Default Value	No default value

8.4.17 MC 1: Read Number of File System Test Cycles 201B_h

Designation	Value
Name	MC 1: Read Number of File System Test Cycles
Index	201Bh
Object Code	VARIABLE
No. of Elements	0
Data Type	UNSIGNED32
Access	Read
PDO Mapping	No
Default Value	No default value

8.4.18 MC 1: Read Number of IAR Test Cycles 201C_h

Designation	Value
Name	MC 1: Read Number of IAR Test Cycles
Index	201Ch
Object Code	VARIABLE
No. of Elements	0
Data Type	UNSIGNED32
Access	Read
PDO Mapping	No
Default Value	No default value

8.4.19 SW Build No 210A_h

Bezeichnung	Wert
Name	SW Build No

Index	210Ah
Object Code	VARIABLE
No. of Elements	0
Data Type	UNSIGNED16
Access	Read
PDO Mapping	No
Default Value	No default Value

8.4.20 Read MC 3 Error 2210_h

Designation	Value
Name	Read MC 3 Error
Index	2210h
Object Code	RECORD
No. of Elements	3

Designation	Value
Name	Number of Entries
Subindex	00h
Data Type	UNSIGNED8
Access	Read only
PDO Mapping	No
Default Value	3

Designation	Value
Name	MC 3: Error Number
Subindex	01h
Data Type	UNSIGNED16
Access	Read only
PDO Mapping	No

Designation	Value
Name	MC 3: Error Line
Subindex	02h
Data Type	UNSIGNED16
Access	Read only
PDO Mapping	No

Designation	Value
Name	MC 3: Error Module
Subindex	03h
Data Type	UNSIGNED8
Access	Read only

PDO Mapping	No
-------------	----

8.4.21 Read MC 1 Runtimes 2220_h

Designation	Value
Name	RunTime MC 1
Index	2220h
Object Code	RECORD
No. of Elements	6

Designation	Value
Name	Number of Entries
Subindex	00h
Data Type	UNSIGNED8
Access	Read only
PDO Mapping	No
Default Value	6

Designation	Value
Name	Runtime Main Loop [μ s] (designation in XML file: Act RT)
Subindex	01h
Data Type	UNSIGNED16
Access	Read only
PDO Mapping	No

Designation	Value
Name	Maximum of Main Loop Runtime [μ s] (designation in XML file: Max RT)
Subindex	02h
Data Type	UNSIGNED16
Access	Read only
PDO Mapping	No

Designation	Value
Name	Application Cycle Time (Par. from PS) [μ s] (designation in XML file: App Cycle)
Subindex	03h
Data Type	UNSIGNED16
Access	Read only
PDO Mapping	No

Designation	Value
Name	Application Runtime [μ s]

	(designation in XML file: App RT)
Subindex	04h
Data Type	UNSIGNED16
Access	Read only
PDO Mapping	No

Designation	Value
Name	Application CORA Time [μ s] (designation in XML file: CORA RT)
Subindex	05h
Data Type	UNSIGNED16
Access	Read only
PDO Mapping	No

Designation	Value
Name	Reserved [μ s]
Subindex	06h
Data Type	UNSIGNED16
Access	Read only
PDO Mapping	No

8.4.22 MC 3 Main Loop Cycle Time and Max Cycle Time 2221_h

Designation	Value
Name	MC 3 Main Loop Cycle Time and Max Cycle Time [μ s] (designation in XML file: RunTime MC3)
Index	2221h
Object Code	RECORD
No. of Elements	2

Designation	Value
Name	Number of Entries
Subindex	00h
Data Type	UNSIGNED8
Access	Read only
PDO Mapping	No
Default Value	2

Designation	Value
Name	Runtime Main Loop [μ s] (designation in XML file: Act RT)
Subindex	01h
Data Type	UNSIGNED16
Access	Read only

PDO Mapping	No
Designation	Value
Name	Maximum of Main Loop Runtime [μ s] (designation in XML file: Max RT)
Subindex	02h
Data Type	UNSIGNED16
Access	Read only
PDO Mapping	No

8.4.23 Free Disk Space / App Size Information 2230_h

Designation	Value
Name	Free Disk Space / App Size Information (designation in XML file: Free Disk Space)
Index	2230h
Object Code	RECORD
No. of Elements	4

Designation	Value
Name	Number of Entries
Subindex	00h
Data Type	UNSIGNED8
Access	Read only
PDO Mapping	No
Default Value	4

Designation	Value
Name	Actual Local Free Disk Space [Byte] (designation in XML file: Local)
Subindex	01h
Data Type	UNSIGNED16
Access	Read only
PDO Mapping	No

Designation	Value
Name	Actual Global Free Disk Space [Byte] (designation in XML file: Global)
Subindex	02h
Data Type	UNSIGNED16
Access	Read only
PDO Mapping	No

Designation	Value
--------------------	--------------

Name	Actual Application Code Size [Byte] – max.400kByte (designation in XML file: App Code)
Subindex	03h
Data Type	UNSIGNED16
Access	Read only
PDO Mapping	No

Designation	Value
Name	Actual Application Data Size [Byte] – max.112kByte (designation in XML file: App Data)
Subindex	04h
Data Type	UNSIGNED16
Access	Read only
PDO Mapping	No

8.4.24 ST CPU Chip Id MC 1 (96-bit Serial Number) 5001_h

Designation	Value
Name	ST CPU Chip Id MC 1 (96-bit Serial Number) (designation in XML file: Id MC1)
Index	5001h
Object Code	RECORD
No. of Elements	4

Designation	Value
Name	Number of Entries
Subindex	00h
Data Type	UNSIGNED8
Access	Read only
PDO Mapping	No

Designation	Value
Name	MC 1 Id Received : 1 - OK, 0 - failed (designation in XML file: Id rx from MC1)
Subindex	01h
Data Type	UNSIGNED16
Access	Read only
PDO Mapping	No

Designation	Value
Name	Id Bits 0...31 (designation in XML file: Bits 0-31)
Subindex	02h
Data Type	UNSIGNED16

Access	Read only
PDO Mapping	No

Designation	Value
Name	Id Bits 32...63 (designation in XML file: Bits 32-63)
Subindex	03h
Data Type	UNSIGNED16
Access	Read only
PDO Mapping	No

Designation	Value
Name	Id Bits 64...95 (designation in XML file: Bits 64-95)
Subindex	04h
Data Type	UNSIGNED16
Access	Read only
PDO Mapping	No

8.4.25 ST CPU Chip Id MC 3 (96-bit Serial Number) 5003_h

Designation	Value
Name	ST CPU Chip Id MC 3 (96-bit Serial Number) (designation in XML file: Id MC3)
Index	5003h
Object Code	RECORD
No. of Elements	4

Designation	Value
Name	Number of Entries
Subindex	00h
Data Type	UNSIGNED8
Access	Read only
PDO Mapping	No
Default Value	4

Designation	Value
Name	Identification State: 1 - OK, 0 - failed (designation in XML file: Id valid)
Subindex	01h
Data Type	UNSIGNED16
Access	Read only
PDO Mapping	No

Designation	Value
Name	Id Bits 0...31
Subindex	02h
Data Type	UNSIGNED16
Access	Read only
PDO Mapping	No

Designation	Value
Name	Id Bits 32...63
Subindex	03h
Data Type	UNSIGNED16
Access	Read only
PDO Mapping	No

Designation	Value
Name	Id Bits 64...95
Subindex	04h
Data Type	UNSIGNED16
Access	Read only
PDO Mapping	No

8.5 Objects for Internal Use Only

The objects listed below are not intended for use by the end user. Some of them are used for configuration purposes.

Object	Explanation/Designation
0x10F1h	Error Settings
0x1C00h	Sync Manager Type
0x1C32h	SM Output Parameter
0x1C33h	SM Input Parameter
0x2000h	Ref Voltage for μ C1
0x2002h	Supply 5 Voltage to μ C1
0x2003h	Supply 3.3 Voltage to μ C1
0x200Bh	Number of CORA Test Cycles of μ C1
0x2020h	MaxAsicDataUnequalCounter
0x2212h	Post Result Flag
0x2220h	MC1 Main Loop Cycle Time
0x5001h	Id MC1
0x5003h	Id MC3
0x5E5Eh	Creates the 'device stamp'

8.6 Standards Complied With

8.6.1 Product Standard Applied

- EMC Directive 2014/30/EU
- EN 61131-2:2007
Programmable logic controllers – Part 2: Equipment requirements and tests

8.6.2 Safety Standards and Directives

- IEC 61508:2010 Parts 1-7
Functional safety of electrical/electronic/programmable electronic safety-related systems
- EN ISO 13849-1:2015
Safety of machinery – Safety-related parts of control systems - Part 1: General principles for design
- EN 62061:2005 + AC:2010 + A1:2013 + A2:2015
Safety of machinery - Functional safety of electrical, electronic and programmable electronic safety-related control systems
- EN 60204-1:2006 + A1:2009 + AC:2010 (excerpts)
Safety of machinery – Safety-related parts of control systems - Part 1: General principles for design

8.6.3 EMC Standards

EMC immunity to noise:

- Generic standard EN 61000-6-2:2005
Electromagnetic Compatibility (EMC) - Part 6-2: Generic standards - Immunity for industrial environments
- Product standard EN 61131-2:2007
Programmable logic controllers – Part 2: Equipment requirements and tests

Elevated immunity levels of safety-related applications

- EN 61131-6:2012
Programmable logic controllers – Part 6: Functional safety

EMC noise emission

- Generic standard EN 61000-6-4:2007 + A1:2011
Electromagnetic Compatibility (EMC) - Part 6-4: Generic standards – Emission standard for industrial environments
- Product standard EN 61131-2:2007
Programmable logic controllers – Part 2: Equipment requirements and tests

8.7 Directives and declarations

8.7.1 Declaration of conformity



PRECISION. SAFETY. MOTION.

Kendrion Kuhnke Automation GmbH
 Löffelburger Straße 101
 28744 Malente
 Deutschland
 T +49 4522 400-0
 F +49 4522 400-201

Konformitätserklärung Declaration of Conformity

Wir erklären, dass das nachfolgend bezeichnete Produkt den Bestimmungen der unten markierten EG- Richtlinien entspricht.

We declare that the following named product conforms with the requirements of the below marked EEC Directives.

Bezeichnung/ Description	Kuhnke FIO Safety PLC
Typ/ Type	Best.-Nr. 854 330 00
Kendrion Kuhnke Ident-Nr./ Kendrion Kuhnke Identification number	187357
Angewandte Normen/ Considered standards	EN 61131-2:2007 (Auszugsweise), EN 61131-2:2012, IEC 61508:2010 Teile 1-7
Angewandte harmonisierte Normen (EMV)/ Considered harmonized standards (EMC)	EN 61131-2:2007 (Kapitel 8, 9 und 10)
Angewandte harmonisierte Normen (MRL)/ Considered Harmonized standards (MD)	EN ISO 13849-1:2015, EN 62061:2005 + AC:2010 + A1:2013 + A2:2016
Benannte Stelle (bezgl. MRL 2006/42/EG)/ Notified Bodies	TUV Rheinland Industrie Service GmbH 51136 Köln / Deutschland Benannte Stelle Nr.: 0036

Berücksichtigte EG-Richtlinie:
Considered EEC-Directives:

- 2014/30/EU Elektromagnetische Verträglichkeit EMV /
Electromagnetic compatibility EMC
- 2006/42/EG Maschinenrichtlinie, Baumusterbescheinigung (01/205/5559 00/17) /
Machinery Directive, EC Type-Examination Certificate (01/205/5559 00/17)

Wird das Produkt in eine Maschine eingebaut oder mit anderen Maschinen zu einer Maschine zusammengesetzt, so ist vor der Inbetriebnahme zu prüfen, ob die Maschine, in dieses Produkt eingebaut werden soll, den Bestimmungen der Richtlinien entspricht.

If the device is mounted in a machine or assemblies with other machinery to constitute a machine in front of the operation of the machine it is necessary to test that the machine itself conforms with the requirements of the directive.

Malente, 28.06.2022

Ort, Datum
Place, date of issue



Entwicklungsleiter/
Development Manager

RF-C108/0019

[Internal]

Seite 1 von 1

The original EC Declarations of Conformity and the related documentation are kept at the disposal of the competent authorities. Please contact the product management department if necessary.

8.7.2 RoHS 3 conformity

KENDRION		PRECISION. SAFETY. MOTION.
		Kendrion Kuhnke Automation GmbH Lütjenburger Straße 101 23714 Malente Deutschland T +49 4523 402-0 F +49 4523 402-201
RoHS 3- Konformität RoHS 3- Conformity		
Wir bestätigen, dass das nachfolgend bezeichnete Produkt den aufgeführten Beschränkungen für Stoffe nach EU-Richtlinie 2011/65/EU, delegierten Richtlinie 2015/863/EU und ElektroStoffVerordnung (ElektroStoffV) entspricht. Unsere Zulieferer haben uns die RoHS-Konformität ihrer Produkte bestätigt. Eine Gewährleistung zu der Richtigkeit der Aussage leitet sich, trotz genauer Prüfung dieser Information, hieraus nicht ab. Als nachgeschalteter Anwender liefern wir Komponenten, die nicht der Kennzeichnungspflicht (CE) gemäß der EU-Richtlinie 2011/65/EU unterliegen.		
We approve that the product named in the following conforms with the restricted substances referred to EU-Directive 2011/65/EU, Commission Delegated Directive 2015/863/EU and ElektroStoffVerordnung. Our suppliers have confirmed the RoHS conformity of her products. In spite of an exact check of this information no warranty to the correctness of the statement can be deduced. Acting as a downstream user, the delivered components are not subject to CE-marking under this directive.		
Bezeichnung/ Description	FIO EtherCAT I/O modules	
Typ/ Type	Kuhnke FIO EtherCAT I/O modules inclusive components and all brand label versions	
Kendrion Kuhnke Bestellnummer Kendrion Kuhnke order number	694.XXX.XXX... (X can be any alphanumeric character or blank)	
Verwendete Ausnahmen gemäß EU-Richtlinie 2011/65/EU Anhang III, 6 a –c Exceptions used according to EU- Directive 2011/65/EU Annex III, 6 a –c		
Folgend die Stoffe, die den Beschränkungen gemäß EU-Richtlinie 2011/65/EU, delegierten Richtlinie 2015/863/EU und ElektroStoffVerordnung (ElektroStoffV) unterliegen: Following restricted substances referred to EU-Directive 2011/65/EU, Commission Delegated Directive 2015/863/EU and ElektroStoffVerordnung:		
Blei/ Lead Quecksilber/ Mercury Cadmium/ Cadmium Sechswertiges Chrom/ Hexavalent chromium Polybromiertes Biphenyle (PBB)/ Polybrominated biphenyls (PBB) Polybromiertes Diphenylether (PBDE)/ Polybrominated diphenyl ethers (PBDE) Di(2-ethylhexyl)phthalat (DEHP)/ Bis(2-ethylhexyl)phthalat (DEHP) Butylbenzylphthalat (BBP)/ Butyl benzyl phthalate (BBP) Dibutylphthalat (DBP)/ Dibutyl phthalate (DBP) Diisobutylphthalat (DIBP)/ Diisobutyl phthalate (DIBP)		
Malente, 03.09.2019		
Ort, Datum Place, date of issue	Entwicklungsleiter/ Development Manager	
KE-0074/0619	Seite 1 von 1	

8.7.3 TÜV certificate

EC Type-Examination Certificate





**Product Safety
Functional
Safety**

www.tuv.com
ID: 960000000

Reg.-Nr./No.: 01/205/5599.00/17

Prüfgegenstand Product tested	Sichere speicherprogrammierbare Steuerung (SPS) mit FSoE Schnittstelle Safety programmable logic controller (PLC) with FSoE Interface	Zertifikats- inhaber Certificate holder	Kendrion Kuhnke Automation GmbH Lütjenburger Str. 101 23714 Malente Germany
Typbezeichnung Type designation	Kuhnke FIO Safety PLC - 694 330 00		
Prüfgrundlagen Codes and standards	EN ISO 13849-1:2015 IEC 62061:2015 + AC:2015 IEC 61508 Parts 1-7:2010	EN 61131-2:2007 EN 60204-1:2006 + A1:2009 + AC:2010 (in extracts) IEC 61326-3-1:2008 + AC:2008	
Bestimmungsgemäße Verwendung Intended application	Die sichere speicherprogrammierbare Steuerung erfüllt die Anforderungen der Prüfgrundlagen (Kat. 4 / PL e nach EN ISO 13849-1, SIL CL 3 nach IEC 62061 / IEC 61508) und kann in Anwendungen bis zu diesen Sicherheitsleveln eingesetzt werden. The safety programmable logic controller complies with the requirements of the relevant standards (Cat. 4 / PL e acc. to EN ISO 13849-1, SIL CL 3 acc. to IEC 62061 / IEC 61508) and can be used in applications up to these safety levels.		
Besondere Bedingungen Specific requirements	Die Hinweise in der zugehörigen Installations- und Betriebsanleitung sowie des Sicherheitshandbuchs sind zu beachten. The instructions of the associated installation, Operating and Safety Manual shall be considered.		

Es wird bestätigt, dass der Prüfgegenstand mit den Anforderungen nach Anhang I der Richtlinie 2006/42/EG über Maschinen übereinstimmt.
It is confirmed, that the product tested complies with the requirements for machines defined in Annex I of the EC Directive 2006/42/EC.

Gültig bis / Valid until 2022-07-04

Der Ausstellung dieses Zertifikates liegt eine Prüfung zugrunde, deren Ergebnisse im Bericht Nr. 968/FSP 1413.00/17 vom 04.07.2017 dokumentiert sind.
Dieses Zertifikat ist nur gültig für Erzeugnisse, die mit dem Prüfgegenstand übereinstimmen. Es wird ungültig bei jeglicher Änderung der Prüfgrundlagen für den angegebenen Verwendungszweck.
The issue of this certificate is based upon an examination, whose results are documented in Report No. 968/FSP 1413.00/17 dated 2017-07-04.
This certificate is valid only for products which are identical with the product tested. It becomes invalid at any change of the codes and standards forming the basis of testing for the intended application.



Berlin, 2017-07-04

Notified Body for Machinery, NB 0035



Dipl.-Ing. Eberhard Frejno

www.fs-products.com
www.tuv.com



TÜVRheinland[®]
Precisely Right.

10.02.12, 12.11.14 © TÜV, TÜV and TÜV are registered trademarks. Utilization and application requires prior approval.

TÜV Rheinland Industrie Service GmbH, Altehrstr. 66, 12103 Berlin / Germany
Tel: +49 30 7003-1507, Fax: +49 30 7003-1570, E-Mail: kontakt@tuv.com

8.8 Table of Figures

- Fig. 1: Safety PLC 15
- Fig. 2: System overview 16
- Fig. 3: FIO system 17
- Fig. 4: FSoE logo..... 18
- Fig. 5: CODESYS logo 18
- Fig. 6: PLCopen logo..... 19
- Fig. 7: External features of the Safety PLC module 20
- Fig. 8: Response time in the system group (example) 27
- Fig. 9: Dimensions, in mm 29
- Fig. 10: Imprinted texts and symbols..... 31
- Fig. 11: Front view showing the serial number (SN) 32
- Fig. 12: Status LEDs..... 33
- Fig. 13: Mounting position and minimum distances, in mm 36
- Fig. 14: Mounting a module 37
- Fig. 15: Disconnecting modules 38
- Fig. 16: Removing a module..... 38
- Fig. 17: Earthing (example of an I/O module) 39

9 Sales & Service

Please visit our Internet site to find a comprehensive overview of our sales and service network including all the relevant addresses. Feel free to also contact us at our headquarters in Malente/Germany:

KENDRION
WE MAGNETISE THE WORLD

INDUSTRIAL CONTROL SYSTEMS

Herzlich Willkommen bei
**Kendrion Kuhnke Automation
Industrial Control Systems**

Produkte Branchen Kundenspezifische Lösungen Über uns Aktuelles Presse Karriere Kontakt

Kuhnke Steuerungstechnik
Erfahren Sie mehr! ▶

Kuhnke Magnettechnik
Erfahren Sie mehr! ▶

Kuhnke Pneumatik und Fluidtechnik
Erfahren Sie mehr! ▶

Arriva Steuerungstechnik Mobile Automation
Erfahren Sie mehr! ▶

9.1.1 Malente Headquarters

Kendrion Kuhnke Automation GmbH
Industrial Control Systems
Lütjenburger Straße 101
D-23714 Malente, Germany
Tel. +49 4523 402-0
Fax +49 4523 402-201
Email sales-ics@kendrion.com
Web www.kuhnke.kendrion.com