

User Guide

Original Operating Instructions

Version 1.3

Kuhnke FIO Safety SDI4 / SDO2

694 430 00

FIO System Safety Terminal

E 818 GB

15. Nov 2022 / Document Number 10235625



Safety over
EtherCAT®

Table of Contents

1	Legal Notice.....	6
1.1	Contact Details	6
1.2	Version Details.....	6
1.2.1	Manual.....	6
1.2.2	FIO Safety SDI4 / SDO2 Order Number 694 430 00	6
2	Preface	8
2.1	About this User Guide	8
2.1.1	Limitation of Liability	8
2.1.2	Terms of Delivery	8
2.1.3	Copyright	8
2.1.4	Warranty	8
2.2	Reliability, Safety	9
2.2.1	Applicability	9
2.2.2	Target Group	9
2.2.3	Reliability	9
2.2.4	Hazard and Other Warnings	9
2.2.5	Other Notices	10
2.2.6	Safety	10
2.2.7	Project Planning and Installation.....	11
2.2.8	Maintenance and Servicing.....	11
2.2.9	General Notes on Installation.....	11
3	System Description.....	13
3.1	EtherCAT® – Ethernet Control	13
3.2	Kuhnke FIO.....	13
3.3	Kuhnke FIO Safety System	13
3.3.1	Safety over EtherCAT (FSoE).....	13
3.3.2	Kuhnke FIO Safety PLC.....	14
3.3.3	Kuhnke FIO Safety I/O	14
3.3.4	CODESYS Safety.....	14
3.3.5	CODESYS SafetyPLCopen Library	15
4	Product Description	16
4.1	General Description	16
4.2	Application	16
4.2.1	Intended Use	16
4.2.2	Qualified Persons	17
4.2.3	Disclaimer of Liability	17
4.3	Safe State	17
4.3.1	Safe Functional State	17
4.3.2	Fail-Safe State – External Fault	17
4.3.3	Fail-Safe State – Internal Fault	17
4.3.4	Traceability	18
4.4	Useful Life.....	18
4.5	Technical Data.....	19
4.5.1	General Specifications	19
4.5.2	Safe Digital Inputs	20
4.5.3	Safe Digital Test Pulse Outputs	20
4.5.4	Safe Digital Outputs	21
4.6	Safety-related Input Ratings	22
4.6.1	Safety-related Ratings of a Single-channel Application	22

4.6.2	Safety-related Ratings of a Two-channel Application	23
4.7	Safety-related Output Ratings	24
4.7.1	Safety-related Ratings of a Single-channel Application	24
4.7.2	Safety-related Ratings of a Two-channel Application	25
4.8	Response Time	26
4.9	Dimensions	28
4.10	Transport and Storage.....	28
5	Construction and Functionality	29
5.1	Labelling and Identification	29
5.1.1	Imprinted Texts and Symbols.....	29
5.1.2	Serial Number	30
5.2	Contents of Package	30
5.3	Connectors	31
5.3.1	E-bus and Module Lock	31
5.3.2	Spring-assisted Combi Plug X1	32
5.3.3	Wiring Example	33
5.3.4	I/O Supply.....	34
5.4	Indicators and Controls.....	35
5.4.1	LED "EtherCAT Run"	35
5.4.2	LED "Safe Status"	35
5.4.3	LED "Power"	35
5.4.4	LEDs "Channel".....	36
5.5	Operating Software.....	37
6	Installation and Operation.....	38
6.1	Mechanical Installation	38
6.1.1	Mounting Position.....	39
6.1.2	To Snap on a Single Module	40
6.1.3	To Interconnect Two Modules.....	40
6.1.4	To Disconnect Two Modules.....	41
6.1.5	To Take Down a Single Module	41
6.2	Electrical Installation.....	42
6.2.1	Earth.....	42
6.2.2	Module Interconnection.....	42
6.2.3	System Power Supply	43
6.2.4	I/O Supply.....	43
6.2.5	Sensor and Actuator Power Supply	44
6.2.6	Power Supply Wiring Example	45
6.2.7	Sensor Connection.....	46
6.2.8	Actuator Connection.....	49
6.2.9	Multiple socket connector (MSC)	53
6.3	Configuration	54
6.3.1	Address Setup.....	54
6.3.2	FSoE Parameters.....	55
6.3.3	Input Parameters.....	59
6.3.4	Output Parameters	60
6.4	Putting into Service.....	62
6.5	Diagnosis	63
6.5.1	Self-test	63
6.5.2	Kuhnke FIO Safety I/O Module Faults	63
6.5.3	Wrong Wiring.....	63

6.5.4 Temperature Faults	63
6.5.5 Wrong Supply Voltage	64
6.5.6 Table of Faults.....	64
6.5.7 Error Codes	65
6.5.8 EtherCAT Link Lost	66
6.5.9 Wrong FSoE Address	66
6.5.10 Wrong Configuration of the Kuhnke FIO Safety SDI4/SDO2 Module.....	66
6.6 Reset / Acknowledge Error.....	67
6.7 Maintenance / Servicing	67
6.7.1 General.....	67
6.7.2 Servicing.....	67
6.7.3 Preventive Maintenance.....	68
6.8 Replacing a Kuhnke FIO Safety I/O Module	68
6.9 Durability.....	69
6.9.1 Repairs / Customer Service	69
6.9.2 Warranty.....	69
6.9.3 Taking out of Service	69
6.9.4 Disposal.....	69
7 Connection Examples.....	70
7.1 Safety Function with Single-channel Input	71
7.2 Safety Function with Two-channel Input	72
7.3 Two-hand Actuation.....	73
7.4 Mode Selector, Rotary Table.....	74
7.5 Safety Mats, Connecting Blocks and Bumpers	75
7.6 Connecting Two Actuators with Internal GND Reference	76
7.7 Connecting Two Parallel Actuators to One Safe Output	78
8 Appendix.....	80
8.1 Object Dictionary	80
8.1.1 Device Type 1000h.....	80
8.1.2 Error Register 1001h.....	80
8.1.3 Manufacturer Device Name 1008h	80
8.1.4 Manufacturer Hardware Version 1009h	81
8.1.5 Manufacturer Software Version 100Ah	81
8.1.6 Identity Object 1018h	81
8.1.7 Supply 24V Voltage 2001 _h for μ C1 and 2011 _h for μ C2	82
8.1.8 Out 1 Current 2005 _h for μ C1 and 2015 _h for μ C2	83
8.1.9 Ext Temperature 2006 _h for μ C1	83
8.1.10 Err.code 2007 _h for μ C1 and 2017 _h for μ C2	83
8.1.11 Err.line 2008 _h for μ C1 and 2018 _h for μ C2.....	88
8.1.12 Err.module 2009 _h for μ C1 and 2019 _h for μ C2	88
8.1.13 Err.class 200A _h for μ C1 and 201A _h for μ C2	89
8.1.14 System Uptime [s] 200C _h	90
8.1.15 Temperature Warning 0x2016 _h	90
8.1.16 Objects - For Internal Use Only.....	90
8.2 Standards Complied With.....	92
8.2.1 Product Standard Applied	92
8.2.2 Safety Standards and Directives.....	92
8.2.3 EMC Standards	92
8.3 Regulations and Declarations.....	93
8.3.1 Mark of Conformity	93

8.3.2 TÜV Certificate94

8.4 Permits.....95

8.5 Order Specifications95

8.5.1 Basic Units95

8.5.2 Accessories95

8.5.3 Spare Parts95

9 Sales & Service96

9.1.1 Malente Headquarters.....96

1 Legal Notice

1.1 Contact Details

Kendrion Kuhnke Automation GmbH

Industrial Control Systems

Lütjenburger Straße 101

D-23714 Malente, Germany

Tel. +49 4523 402-0

Fax +49 4523 402-201

Email sales-ics@kendrion.com

Web www.kuhnke.kendrion.com

1.2 Version Details

1.2.1 Manual

Modification history

Date	Comments / modifications
21. July 2016	Original manual version 1.0 - for module release V1.0
07. Nov 2016	Object dictionary revised - 8.1 Object Dictionary
30. Jan 2017	Revision of 7.7 Connecting Two Parallel Actuators to One Safe Output
23. Feb 2017	Tüv Certificate added - 8.3.2 TÜV Certificate
26. Apr 2017	Corrections in chapter 6.5.7 Error Codes (hex-codes) and 8.1.10 Err.code 2007h for µC1 and 2017h for µC2 has been supplemented by two entries (0x0296, 0x02A0)
21. June 2017	Corrections in the description of the inputs and outputs in the table of the safety related ratings 4.6 and 4.7. No changes in the ratings.
04. Sep 2017	Footnote in chapter 6.3.2 FSoE Parameters inserted
19. Mar 2018	Note added to the ERRATA_Sheet_Safety Additionally: unique date format selected
14. May 2018	Note inserted for single-channel applications. "Consideration of the parameterization"
18. May 2018	Note inserted for two-channel applications added. See chapter 6.2.7 and 7.5
11 Dec 2018	Several Hazard and Other Warnings adapted. See chapter 6.3.4 and 7
26 Mar 2019	Change in chapter 6.2.7 Sensor Connection, "A high signal is sent from both inputs when the Safety Mat is stepped on"
15 Nov 2022	Maximum output switching frequency added in chapter 4.5.4 Safe Digital Outputs.

1.2.2 FIO Safety SDI4 / SDO2 Order Number 694 430 00

The table below summarises the module releases, manual versions, production dates and the changes to the functionality.

Modul release

Version	Manual	Date	Comments / modifications
V1.00	V1.0	From 21. July 2016	Applies to module release V1.00 → software version 1.0; hardware version V2.1
V1.01	V1.1	From 19. Mar 2018	Applies to module release V1.01 → software version 1.0; hardware version V2.1
V1.02	From V1.2	From 10 Sep 2018	Applies to module release V1.02 → software version 1.0; hardware version V2.1

2 Preface

2.1 About this User Guide

This document is the original user guide to Kuhnke's FIO Safety I/O Module, order number 694 430 00. Your module work should always be based on the correct user guide version → 1.2 Version Details.

This document is primarily directed to system designers, project engineers and device developers. It does not contain any availability information. We reserve the rights for errors, omissions and modifications. Pictures are similar.



Note, information

Please also note the ERRATA_Sheet_Safety for currently relevant safety warnings. The current version can be found in our product finder [Link](#).

2.1.1 Limitation of Liability

Specifications are for description only and are not to be understood as guaranteed product properties in a legal sense. Exact properties and characteristics shall be agreed in the specific contract. Claims for damages against us - on whatever grounds - are excluded, except in instances of deliberate intent or gross negligence on our part.

2.1.2 Terms of Delivery

The general conditions of sales and service of Kendrion Kuhnke Automation GmbH shall apply.

2.1.3 Copyright

© Kendrion Kuhnke Automation GmbH

This user guide is protected by copyright.

No part of this document may be reproduced or copied in any way or by any means except expressly permitted in writing by Kendrion Kuhnke Automation GmbH.

Microsoft®, Windows® and the Windows® logo are registered trademarks of Microsoft Corp. in the USA and other countries.

EtherCAT® is a registered brand and patented technology, licenced by Beckhoff Automation GmbH, Germany.

Safety over EtherCAT is a registered trademark and patented technology, licenced by Beckhoff Automation GmbH, Germany

Further information about the PLCopen organisation is available at www.plcopen.org. CiA® and CANopen® are registered joint brands of CAN in Automation e.V. Title to all companies and company names mentioned herein as well as to products and product names is held by the respective enterprises.

2.1.4 Warranty

Warranty is subject to the provisions of the conditions of sale of Kendrion Kuhnke Automation GmbH or any contractual agreements between the parties.

The warranty will be voided by:

- improper assembly and use
- repairs or inadmissible servicing
- modifications or rendering the serial number illegible or removing it

2.2 Reliability, Safety

2.2.1 Applicability

This user guide contains all information necessary for the use of the described product (control device, control terminal, software, etc.) according to instructions.

2.2.2 Target Group

The user guide is written for design, project planning, servicing and commissioning experts. For proper understanding and error-free application of technical descriptions, instructions for use and particularly of notes of danger and warning, extensive knowledge of automation technology and functional safety is compulsory.

2.2.3 Reliability

Reliability of Kuhnke products is brought to the highest possible standards by extensive and cost-effective means in their design and manufacture.

These include:

- selecting high-quality components,
- quality agreements with our suppliers,
- actions to avoid static charges when handling MOS circuits,
- worst case planning and design of all circuits,
- visual inspections at various stages of fabrication,
- computer-aided tests of all assemblies and their interaction in the circuit,
- statistical assessment of the quality of fabrication and of all returned goods for the immediate taking of appropriate corrective actions.
- standardised returns handling process
- ISO 9001:2015 certification

2.2.4 Hazard and Other Warnings

Despite the actions described in section 2.2.3 Reliability, the occurrence of faults or errors in electronic control units - even if most highly improbable - must be taken into consideration.



Please pay particular attention to the additional notices which we have marked by symbols throughout this user guide. While some of these notices make you aware of possible dangers, others are intended as a means of orientation. They are described further down below in descending order of importance.

Every alert and hazard warning is made up as follows:

Type and source of risk

Potential consequences of non-observance

⇒ Preventive measures

	DANGER
	<i>A DANGER warning makes you aware of an immediately hazardous situation which WILL cause a serious or fatal accident if not observed.</i>
	WARNING
	<i>A WARNING makes you aware of a potentially hazardous situation which MAY cause a serious or fatal accident or damage to this or other devices if not observed.</i>

	CAUTION
	<i>A CAUTION alert makes you aware of a potentially hazardous situation which MAY cause an accident or damage to this or other devices if not observed.</i>

	ATTENTION
	<i>An ATTENTION notice makes you aware of a potentially hazardous situation which MAY cause damage to this or other devices if not observed.</i>

2.2.5 Other Notices

	Note, information
	<i>This symbol draws your attention to additional information concerning the use of the described product. This may include cross references to information found elsewhere (e.g. in other manuals).</i>

2.2.6 Safety

Our products normally become part of larger systems or installations. The information below is intended to help you integrate the product into its environment without dangers to humans or material/equipment.

	DANGER
	<p>Non-compliance with the user guide</p> <p><i>Measures for the prevention of dangerous faults or errors may be rendered ineffective or new hazard sources created.</i></p> <ul style="list-style-type: none"> • <i>Carefully read the user guide</i> • <i>Take particular heed of the hazard warnings</i>

	Information
	<i>To achieve a high degree of conceptual safety in planning and installing an electronic controller, it is essential to exactly follow the instructions given in the user guide because wrong handling could lead to rendering measures against dangers ineffective or to creating additional dangers.</i>

2.2.7 Project Planning and Installation

- Emergency-off installations must comply with EN 60204/IEC 204 (VDE 0113). They must be operative at any time.
- Safety and precautions regulations for qualified applications have to be complied with.
- Please pay particular attention to the notices of warning which, at relevant places, will make you aware of possible sources of dangerous mistakes or faults.
- Relevant standards and VDE regulations are to be complied with in every case.
- Control elements are to be installed in such a way as to exclude unintended operation.
- Lay control cables such that interference (inductive or capacitive) is excluded if this interference could influence controller operation or its functionality.

2.2.8 Maintenance and Servicing

- Accident prevention regulations (in Germany: BGV A3 - VBG 4.0) to be observed when measuring or checking a controller after power-up. This applies to section 8 (Admissible deviations when working on parts) in particular.
- You are not allowed to repair Kuhnke's FIO Safety I/O Module. Please return the module to Kendrion Kuhnke Automation GmbH if defective.
- Spare parts:
Only use parts approved of by Kendrion Kuhnke Automation GmbH. Only genuine Kuhnke modules may be used in modular controllers.
- Modular systems: always plug or unplug modules in a power-down state. You may otherwise damage the modules or (possibly not immediately recognisably!) inhibit their functionality.
- Always dispose of (rechargeable) batteries as hazardous waste.

2.2.9 General Notes on Installation

As component parts of machines, facilities and systems, electronic control systems must comply with valid rules and regulations, depending on their field of application.

General requirements concerning the electrical equipment of machines and aiming at the safety of these machines are contained in Part 1 of European Standard EN 60204 (corresponds to VDE 0113).

	Information
	<i>In order to safely install Kuhnke's FIO Safety System, please read section → 2.2.7 Project Planning and Installation and following.</i>

Interference emission

Interfering emission of electromagnetic fields, HF compliant to EN 55011, limiting value class A, Group 1

	Information
	<i>If the controller is designed for use in residential areas, high-frequency emissions must comply with limiting value class B as described in EN 55011. Fitting the controller into earthed metal cabinets and installing filters in the supply lines may produce a shielding compliant to the above standard.</i>

The design and immunity to interference of programmable logic controllers are internationally governed by standard IEC 61131-2:2007 which, in Europe, has been the basis for European Standard EN 61131-2:2007 .

	Note
--	-------------



Refer to IEC 61131-4, User's Guideline, for general installation instructions to be complied with to ensure that hardware interface factors and the ensuing noise voltages are limited to tolerable levels.

Electrical immission safeguard

To eliminate electromagnetic interference, connect the control system to the protective earth conductor. Practice best cable routing.

Cable routing and wiring

Keep power circuits separate from control circuits:

- DC voltages 60 V ... 400 V
- AC voltages 25 V ... 400 V

Joint laying of control circuits is allowed for:

- shielded data signals
- shielded analogue signals
- unshielded digital I/O lines
- unshielded DC voltages < 60 V
- unshielded AC voltages < 25 V

Location of installation

Ensure that temperatures, contaminations, impact, vibration or electromagnetic interference are no impediment to the installation.

Temperature

Consider heat sources such as general heating of rooms, sunlight, heat accumulation in assembly rooms or control cabinets.

Contamination

Use suitable casings to avoid possible negative influences due to humidity, corrosive gas, liquid or conducting dust.

Impact and vibration

Consider possible influences caused by motors, compressors, transfer lines, presses, ramming machines and vehicles.

Electromagnetic interference

Consider electromagnetic interference from various local sources: motors, switching devices, switching thyristors, radio-controlled devices, welding equipment, arcing, switched-mode power supplies, converters / inverters.

Particular sources of interference: inductive actuators

Switching off inductances (such as from relays, contactors, solenoids or switching magnets) produces surge voltages. It is necessary to reduce these extra voltages to a minimum. Throttling elements could be diodes, Z-diodes, varistors or RC elements. Their rating should conform to the specifications provided by the manufacturer or supplier of the actuators.

3 System Description

3.1 EtherCAT® – Ethernet Control

EtherCAT® is the most powerful Ethernet-based fieldbus system currently available on the market. EtherCAT puts up the top speed mark, and its flexible topology and simple configuration make it the perfect means of controlling extremely fast processes. To give you a clue: 1000 I/Os can be addressed in 30 µs. Because of its high performance, the simple wiring and its open protocol support, EtherCAT is often used as a fast motion control and I/O bus driven by an industrial PC or in conjunction with control technology on a smaller scale.

Its interconnections between the controller at one end and both the I/O modules and drives at the other are as fast as those of a backplane bus. EtherCAT controllers thus nearly act like centralised control systems, overcoming the issue of bus transfer times that conventional fieldbus systems are burdened with.

3.2 Kuhnke FIO

Kuhnke's FIO is a system of I/O modules for interconnecting the process signals in an EtherCAT network. Kuhnke FIO consists of the Kuhnke FIO bus coupler and a range of Kuhnke FIO I/O modules.

The Kuhnke FIO bus coupler converts the physical transfer technology (twisted pair) to LVDS (E-bus) and generates the system voltages required by the LVDS modules. The standard 100 Base Tx lines used for office network communications connect to the one side, the Kuhnke FIO I/O modules for the process signals connect to the other. This is how the Ethernet EtherCAT protocol is retained right through to the last I/O module.

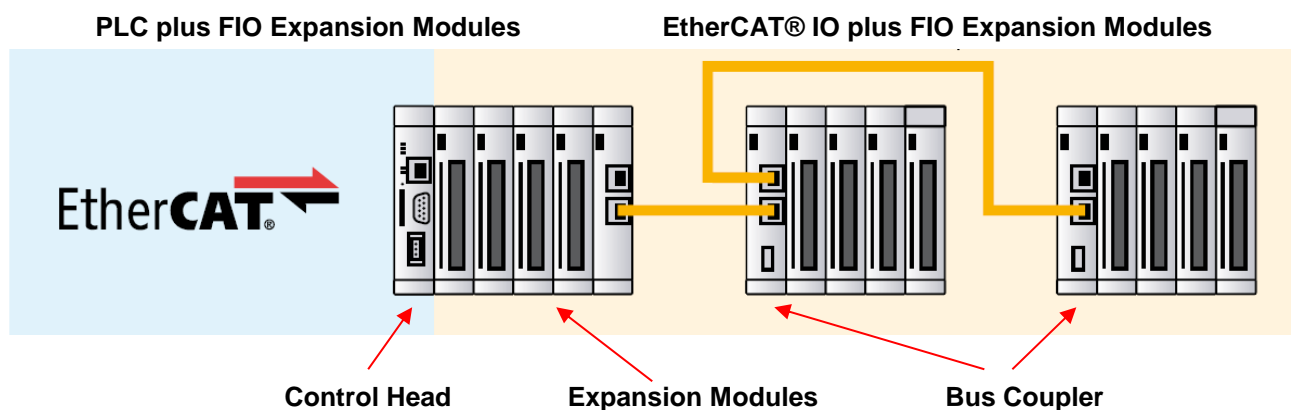

3.3 Kuhnke FIO Safety System

Safe inputs and outputs to expand Kuhnke's FIO module system.

Kuhnke's Safety System allows users to add FIO I/O modules with safe signals to the EtherCAT control unit, making the separate wiring of safety circuits a thing of the past. The EtherCAT protocol is used to transfer both safe and standard signals to the Kuhnke FIO Safety PLC. This integrated transfer process is based on FSoE (Fail Safe over EtherCAT), the safety protocol certified by TÜV, the German Technical Testing & Inspection Association.

3.3.1 Safety over EtherCAT (FSoE)

Along with EtherCAT, a safety protocol was developed and made available for EtherCAT as "Safety over EtherCAT" (FSoE = Fail Safe over EtherCAT). It is the backbone of providing functional safety over EtherCAT. TÜV has since certified both the protocol and its implementation to comply with Safety Integrity Level 3 (SIL 3) to IEC 61508. In 2010, IEC 61784-3-12 was published as the international reference standard for Safety over EtherCAT.

Since EtherCAT is used as a single-channel medium of communication, Safety over EtherCAT does not impose any constraints regarding the transfer rate and cycle time. The transport medium is considered a "black channel" which is left out of the safety assessment.



3.3.2 Kuhnke FIO Safety PLC

Kuhnke's FIO Safety PLC links up the inputs and outputs of FIO Safety and other FSoE system devices. At the basic level, certified function blocks are graphically "wired up" to establish the system's safety programme. In case a project demands more than the technology of the certified blocks can provide, the extra instructions available at the extended level can be used to expand the safety programme.

FIO Safety PLC has been designed as an add-on to a normal CODESYS control unit. This is a two-channel system which uses the normal control unit to communicate with the CODESYS Development System and all non-safe I/Os. Programming is based on a certified plug-in that is fully integrated in the CODESYS Development System.

3.3.3 Kuhnke FIO Safety I/O

Kuhnke's FIO Safety Module provides connections for standard security appliances. It installs at any place of the FIO block. Its signals are transferred by the EtherCAT bus of Kuhnke's FIO Safety PLC and processed in a safe manner. The module outputs safely switch actuators such as contactors, signal lamps or servo converters.



3.3.4 CODESYS Safety

Programming of FIO Safety PLC is based on a certified plug-in that is fully integrated in the CODESYS Development System.

FIO Safety PLC is a sub-node of the standard control unit and provides an application, task, lists of global variables, POEs and logical I/Os.

The integrated function diagram (FD) safety editor (to IEC 61131-3, certified for use with IEC 61508 SIL3 applications) is used for basic or extended-level programming by means of certified function blocks (IEC 61131-3 or PLCopen Safety) as specified in the user manual. Further software functions are available for safeguarding the safety functions by change tracking, safe flow of signals, safe version control (pinning), separating safe operation, debugging mode, etc..



3.3.5 CODESYS SafetyPLCopen Library

The PLCopen components have been defined by the PLCopen organisation, its members and external organisations specialising in all safety-related aspects. Since these are certified components, they reduce the time and costs involved in developing, verifying and testing a safety application for acceptance. They interlink by logical operations which behave like logical wiring and therefore minimise the time and programming efforts needed to create major parts of safety applications.



4 Product Description

4.1 General Description

Kuhnke FIO Safety 694 430 00

Kuhnke FIO Safety features 4 safe inputs and 2 safe outputs for distributed installation.

Figure 1: Module layout shows the basic layout of Kuhnke FIO Safety.

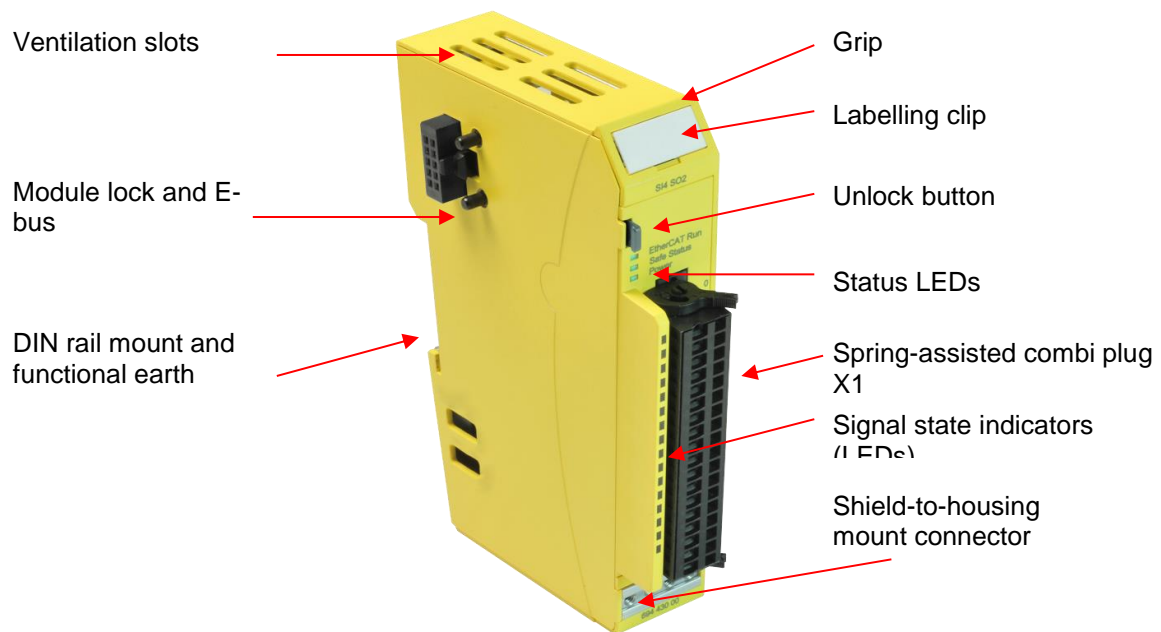

Figure 1: Module layout

The housing mount consists of an aluminium profile with an integrated clamping fixture used to attach the module to a 35 mm DIN rail. The housing trough including the optical fibres for the status indicators, the side faces and the front are made of plastic and contain the module. The optical fibres for the signal state indicators (LEDs) are located next to the spring-assisted combi plug. They slightly protrude from the housing and allow a clear diagnosis at a glance.

4.2 Application

4.2.1 Intended Use

Kuhnke's FIO is a system of I/O modules for interconnecting the process signals in an EtherCAT network. It consists of the bus coupler and a range of I/O modules.

The FIO Safety System comprising Kuhnke FIO Safety PLC, Kuhnke FIO Safety I/O Module and CODESYS Safety Software make the FIO I/O system fit for the functional safety of machinery.

The intended applications of the FIO Safety System include safety functions of machines and all industrial automation tasks immediately associated with them. Thus, the system may only be used for applications providing a defined fail-safe state which, in case of the FIO Safety System, is a wattless state.

Running any of the safety-related control components is subject to the safety precautions applicable to industrial control units, i.e. guarding by emergency stop and similar safety equipment as specified by the relevant national and/or international regulations. The same applies to connected equipment such as drives or light grids. Before installing and putting the system into operation, the safety instructions, connection specifications (nameplate and documentation) and the limiting values listed in this user guide's Technical Data section must be read carefully and obeyed at any time.

The FIO Safety System is not designed for applications causing potentially fatal risks or dangers to the life and health of many persons or disastrous ecological hazards unless exceptionally strict safety precautions

are taken. Such applications specifically include the monitoring of nuclear reactions in nuclear power stations as well as the control of flight or air traffic control systems, means of mass transit, medical life support systems and weapon systems.

4.2.2 Qualified Persons

The safety-related products may be used by the following persons only:

- Qualified persons who know the applicable concepts of functional safety as well as the relevant standards and regulations.
- Qualified persons who plan, design, install and put machine and system safety equipment into operation.

This manual's safety instructions construe qualified persons as persons whose training, experience, instructions and knowledge of the applicable standards, codes, accident prevention regulations and operating conditions authorise them to perform the required work and enable them to recognise and avoid potential hazards associated with that work. Language skills sufficient to understand this manual are therefore part of this qualification.

4.2.3 Disclaimer of Liability

The operator is responsible for self-reliantly running the safety-related control components in conformity with the requirements set by the competent authority.

The manufacturer shall neither be held liable nor accept any warranty for damages caused by:

- inappropriate use
- non-compliance with standard and directives
- unauthorised modifications of devices, connections or settings
- use of unapproved or unsuitable equipment or equipment groups
- non-observance of the safety instructions contained in this manual

4.3 Safe State

There are two different types of "safe states".

The first one is functional and depends on the machine's application, operation and software. It is the aimed-for **safe functional state** at which the system works without problems.

The second one is the **fail-safe state** and applies whenever a fault or error occurs in any of the monitored components.

4.3.1 Safe Functional State

The system is in a safe functional state when the safe process map shows that all inputs are "null" and when the outputs reflect this "null" state by being deenergised at the output. The data frame again reflects this state by "null" in the process map.

4.3.2 Fail-Safe State – External Fault

In case an external fault occurs (short circuit, cross-fault etc.), all outputs are deenergised (outputs "null") and the inputs return "null" to the safe control unit. FSoE communication is not stopped.

A fail-safe state is wattless.

The safety PLC is able to reset this state.

4.3.3 Fail-Safe State – Internal Fault

In case of an internal module fault, all outputs are deenergised (output "null"). Both FSoE communication and the transfer of input information stops.

A fail-safe state is wattless.

Recovering from this state requires a reset by turning the supply voltage off. This involves a complete self-test as part of the initialisation phase.

	CAUTION
	<p><i>Uncontrolled movement of suspended loads, for example</i> <i>Injury caused by moving or non-braked machine parts</i></p> <p>⇒ Additional external safety measures such as a mechanical brake of suspended loads should be provided for applications whose safe state requires an actuator to be actively turned on.</p>

4.3.4 Traceability

Traceability means that the time and entity that produced, processed, stored, transported, consumed or disposed of a product or trading good can be traced back at any time.

Whereas Kendrion is able to meet this requirement with regard to the production, processing, storage and transport, the purchaser is responsible for all further whereabouts of the product.

The serial number on the label stuck to the underside and stored in the object dictionary is the means of distinctly identifying and tracing the product, refer to section → 5.1 Labelling and Identification. To ensure proper traceability, the purchaser is obliged to not down this number together with the machine's name, place of installation and end customer.

	Note, information
	<i>The purchaser must ensure the units' retraceability by means of their serial number.</i>

4.4 Useful Life

The Kuhnke FIO Safety I/O module is designed for a maximum life of 20 years.

It must therefore be taken out of service not later than one week before the end of this 20-year period (calculated as of Kendrion Kuhnke's production date).

The production date is printed on the module as part of its serial number, see section → 5.1.2 Serial Number

4.5 Technical Data

4.5.1 General Specifications

General specifications	
Product name	Kuhnke FIO Safety SDI4/SDO2
Fieldbus	EtherCAT 100 Mbit/s
Controller	ASIC ET1200
Baud rate	100 Mbit/s
E-bus port	10-pin system plug in side wall
Electrical insulation	all modules electrically insulated from one another and from the bus
Diagnosis	LED: bus state, module state, broken wire/excessive current →6.5 Diagnosis
IO/power connection	male 18-pole connector (not included in module package) 18-pole spring-assisted combi plug with mechanical ejector
E-bus load	max. 300 mA (system power supply)
Terminating module	not required
Power supply (I/O / system power supply)	
Supply voltage	24 VDC -15%/+20%
Overvoltage category	category II to EN 61131-2:2007
Module power consumption	approx. 7 mA plus load current
Reverse polarity safeguard	yes
Nominal insulation voltage	500 V _{eff} measured between I/O supply and E-bus
Susceptibility to noise	zone B to EN 61131-2:2007, mounted on earthed DIN rail in earthed control cubicle
Storage and transport conditions	
Temperature	-25°C ... + 70°C
Rel. humidity	5% ... 95%, non-condensing
Atmospheric pressure	70 kPa to 108 kPa / 0 to 3000 m above msl
Vibration	5 Hz to 8.4 Hz: +/- 3.5 mm amplitude, 8.4 Hz to 150 Hz: 10 m/ s ² (1g) to IEC 60068-2-6, Fc test
Shock	150 m/s ² (15g), 11 ms semi-sinusoidal wave to IEC 60068-2-27
Service conditions	
Mounting position	horizontal, stackable
Degree of contamination	II to IEC 60664-3
Admissible operating environment	operation restricted to environments complying with IP54 or better to IEC 60529 (e.g. suitable control cabinet)
Operating temperature	0°C ... + 55°C
Rel. humidity	5% ... 95%, non-condensing
Atmospheric pressure	80 kPa to 108 kPa / 0 to 2000 m above msl
Vibration	5 Hz to 8.4 Hz: +/- 3.5 mm amplitude, 8.4 Hz to 150 Hz: 10 m/ s ² (1g) to IEC 60068-2-6, Fc test
Shock	150 m/s ² (15g), 11 ms semi-sinusoidal wave to IEC 60068-2-27

Mechanical properties	
Mounting	35 mm DIN rail (top-hat rail)
Size	25 mm x 120 mm x 90 mm (W x H x D)
Ingress Protection	IP20
Housing mount	aluminium
Shield	connects straight to module housing

4.5.2 Safe Digital Inputs

Safe digital inputs	
Quantity and type	4x single-channel or 2x two-channel, (EN 61131-2:2007, Type 3)
Diagnosis	cross-fault, external power supply
Highest safety level (depending on configuration)	Single-channel use: Cat. 2/PL d to EN ISO 13849-1:2015, SIL2 to EN 62061:2010 / IEC 61508:2010 Two-channel use: Cat. 3/PL d to EN ISO 13849-1:2015, SIL3 to EN 62061:2010 / IEC 61508:2010
Input delay	300 µs ... 1500 µs (configurable)
Sensor type	use of sensors with OSSD outputs to EN 61496, contact-type sensors
Electrical insulation	channel/channel: no channel/E-bus: 500 V _{eff}
Signal level	Off: -3 V ... 5 V On: 11 V ... 30 V
Maximum voltage	33 V (max. voltage to input even in case of error)
Signal indication	LED located next to terminal and parallel to input
Duration of test impulse	300 µs ... 1500 µs (configurable), phase-shifted to each channel
Safe response time	< 5 ms; see section "Response Time"
Input current	typ. 3.3 mA
Input resistance	typ. 7.3 kΩ
Input capacitance	typ. 100 nF
Maximum line length	100 m (between sensors / module terminals)

4.5.3 Safe Digital Test Pulse Outputs

Safe digital test pulse outputs	
Quantity and type	4
Nominal output current	50 mA, short-circuit-proof
Signal indication	LED located next to the terminal
Switching voltage	24 VDC -15%/+20%
Electric strength	33 V (max. voltage to output even in case of error)
Duration of test impulse	300 µs ... 1500µs, phase-shifted to each channel
Maximum line length	100 m (between sensor / module terminals)

4.5.4 Safe Digital Outputs

Safe digital outputs	
Quantity and type	2x semiconductor, 24 VDC, tolerance to EN 61131-2:2007
Max. safety levels	2x cat. 3/PL e to EN ISO 13849-1:2015, 2x SIL3 to EN 62061:2010, 2x SIL3 to IEC 61508:2010
Diagnosis	cross-fault, external power supply
Signal indication	LED located next to the terminal, controlled by CPU
Minimum output current	2 mA, see → 6.2.8 Actuator Connection for details
Maximum output current	2,0 A, short-circuit-proof, comply with total load and derating See section → 6.2.8 Actuator Connection - Derating of Total Load for details
Maximum output switching frequency	2,5 Hz
Capacitive load	yes, see section → 6.2.8 Actuator Connection for details switching of capacity loads
Braking voltage while turning off inductive loads	typ. 40 VDC
Inductive load	yes, see section → 6.2.8 Actuator Connection for details switching of inductive loads
Maximum line length	100 m (between sensor / module terminals)
Response threshold of output overload protection	min. 2.5 A typ. 3.5 A max. 5.5 A
Output current module _{max}	4 A, comply with total load and derating See section → 6.2.8 Actuator Connection - Derating of Total Load for details
Load resistance range (at nominal voltage)	12 Ω ... 12 kΩ
Electrical insulation	channel/channel: no channel/E-bus: 500 V _{eff}
Approved actuators	DC13 to EN60947-5-1 Table 4 DC1 to EN60947-4
Duration of test impulse	configurable: 500 μs ... 1500 μs (configurable)
Supply voltage	24 VDC -15%/+20%
Electric strength	33 V (max. voltage to output even in case of error)

4.6 Safety-related Input Ratings

4.6.1 Safety-related Ratings of a Single-channel Application

The table below lists the safety-related ratings of a single-channel safety function that uses one input of the safe I/O module. All components involved in the safety function must be taken into account in order to assess whether the desired safety level is achieved.

Safety-related ratings of a single-channel application		
Highest safety integrity level to EN 62061:2010	SIL2	
Highest safety integrity level to EN 61508:2010	SIL2	
Highest performance level to EN ISO 13849-1:2015	Cat. 2/PL d	
Hardware fault tolerance (HFT) in single-channel application (IEC 61508:2010/EN ISO 13849-1:2015)	0 (a fault of the application may cause the safeguard to fail)	
Safety-related ratings	Ambient temperature, 25 °C	Ambient temperature, 55 °C
Probability of failure on demand (PFD _{avg}), proof test interval: 10 years, (IEC 61508:2010) for one input (up to fieldbus)	$5.40 \cdot 10^{-6}$ (0.06% of entire PFD _{avg} of 10^{-2} at SIL2)	$2.23 \cdot 10^{-5}$ (0.23% of entire PFD _{avg} of 10^{-2} at SIL2)
Probability of failure per hour (PFH), proof test interval: 10 years, (IEC 61508:2010) for one input (up to fieldbus)	$1.24 \cdot 10^{-10}$ 1/h (0.02% of entire PFH of 10^{-6} at SIL2)	$5.27 \cdot 10^{-10}$ 1/h (0.05% of entire PFH of 10^{-6} at SIL2)
Probability of failure on demand (PFD _{avg}), proof test interval: 20 years, (IEC 61508:2010) for one input (up to fieldbus)	$1.10 \cdot 10^{-5}$ (0.11% of entire PFD _{avg} of 10^{-2} at SIL2)	$4.77 \cdot 10^{-5}$ (0.48% of entire PFD _{avg} of 10^{-2} at SIL2)
Probability of failure per hour (PFH), proof test interval: 20 years, (IEC 61508:2010) for one input (up to fieldbus)	$1.28 \cdot 10^{-10}$ 1/h (0.02% of entire PFH of 10^{-6} at SIL2)	$5.79 \cdot 10^{-10}$ 1/h (0.06% of entire PFH of 10^{-6} at SIL2)
Diagnostic coverage (DC) to EN ISO 13849-1:2015	98.32%	95.89%
Safe failure fraction (SFF)	99.27%	98.51%
Mean time to dangerous failure (MTTF d) to EN ISO 13849-1:2015	100 years (calculated: 283 years)	100 years (calculated: 185 years)

4.6.2 Safety-related Ratings of a Two-channel Application

The table below lists the safety-related ratings of a two-channel safety function that uses two inputs of the safe I/O module. All components involved in the safety function must be taken into account in order to assess whether the desired safety level is achieved.

Safety-related ratings of a two-channel application		
Highest safety integrity level to EN 62061:2010	SIL3	
Highest safety integrity level to IEC 61508:2010	SIL3	
Highest performance level to EN ISO 13849-1:2015	Cat. 3/PL e	
Hardware fault tolerance (HFT) of two-channel application (IEC 61508:2010/EN ISO 13849-1:2015)	1 (a fault of the application need not cause the safeguard to fail)	
Safety-related ratings	Ambient temperature, 25 °C	Ambient temperature, 55 °C
Probability of failure on demand (PFD _{avg}), proof test interval: 10 years, (IEC 61508:2010) for two inputs (up to fieldbus)	$5,21 \cdot 10^{-6}$ (0.51% of entire PFD _{avg} of 10^{-3} at SIL3)	$2.16 \cdot 10^{-5}$ (2.16% of entire PFD _{avg} of 10^{-3} at SIL3)
Probability of failure per hour (PFH), proof test interval: 10 years, (IEC 61508:2010) for two inputs (up to fieldbus)	$1.20 \cdot 10^{-10}$ 1/h (0.12% of entire PFH of 10^{-7} at SIL3)	$5.11 \cdot 10^{-10}$ 1/h (0.51% of entire PFH of 10^{-7} at SIL3)
Probability of failure on demand (PFD _{avg}), proof test interval: 20 years, (IEC 61508:2010) for two inputs (up to fieldbus)	$1.06 \cdot 10^{-5}$ (1.06% of entire PFD _{avg} of 10^{-3} at SIL3)	$4.62 \cdot 10^{-5}$ (4.62% of entire PFD _{avg} of 10^{-3} at SIL3)
Probability of failure per hour (PFH), proof test interval: 20 years, (IEC 61508:2010) for two inputs (up to fieldbus)	$1.24 \cdot 10^{-10}$ 1/h (0.12% of entire PFH of 10^{-7} at SIL3)	$5.62 \cdot 10^{-10}$ 1/h (0.56% of entire PFH of 10^{-7} at SIL3)
Diagnostic coverage (DC) to EN ISO 13849-1:2015	98,32 %	95,93 %
Safe failure fraction (SFF)	99,28 %	98,59 %
Mean time to dangerous failure (MTTF _d) to EN ISO 13849-1:2015	100 years (calculated: 283 years)	100 years (calculated: 185 years)

4.7 Safety-related Output Ratings

4.7.1 Safety-related Ratings of a Single-channel Application

The table below lists the safety-related ratings of a single-channel safety function that uses one output of the safe I/O module. All components involved in the safety function must be taken into account in order to assess whether the desired safety level is achieved.

Safety-related ratings of a single-channel application		
Highest safety integrity level to EN 62061:2010	SIL2	
Highest safety integrity level to IEC 61508:2010	SIL2	
Highest performance level to EN ISO 13849-1:2015	Cat. 2/PL d	
Hardware fault tolerance (HFT) of single-channel application (IEC 61508:2010/EN ISO 13849-1:2015)	0 (a fault of the application may cause the safeguard to fail)	
Safety-related ratings	Ambient temperature, 25 °C	Ambient temperature, 55 °C
Probability of failure on demand (PFD _{avg}), proof test interval: 10 years, (IEC 61508:2010) for one output (from fieldbus)	$5.36 \cdot 10^{-6}$ (0.06% of entire PFD _{avg} of 10^{-2} at SIL2)	$2.24 \cdot 10^{-5}$ (0.23% of entire PFD _{avg} of 10^{-2} at SIL2)
Probability of failure per hour (PFH), proof test interval: 10 years, (IEC 61508:2010) for one output (from fieldbus)	$1.24 \cdot 10^{-10}$ 1/h (0.02% of entire PFH of 10^{-6} at SIL2)	$5.31 \cdot 10^{-10}$ 1/h (0.06% of entire PFH of 10^{-6} at SIL2)
Probability of failure on demand (PFD _{avg}), proof test interval: 20 years, (IEC 61508:2010) for one output (from fieldbus)	$1,10 \cdot 10^{-5}$ (0.11% of entire PFD _{avg} of 10^{-2} at SIL2)	$4,82 \cdot 10^{-5}$ (0.48% of entire PFD _{avg} of 10^{-2} at SIL2)
Probability of failure per hour (PFH), proof test interval: 20 years, (IEC 61508:2010) for one output (from fieldbus)	$1.28 \cdot 10^{-10}$ 1/h (0.02% of entire PFH of 10^{-6} at SIL2)	$5.89 \cdot 10^{-10}$ 1/h (0.06% of entire PFH of 10^{-6} at SIL2)
Diagnostic coverage (DC) to EN ISO 13849-1:2015	98,40 %	96,56 %
Safe failure fraction (SFF)	99,34 %	98,81 %
Mean time to dangerous failure (MTTF d) to EN ISO 13849-1:2015	100 years (calculated: 264 years)	100 years (calculated: 152 years)

4.7.2 Safety-related Ratings of a Two-channel Application

The table below lists the safety-related ratings of a two-channel safety function that uses two outputs of the safe I/O module. All components involved in the safety function must be taken into account in order to assess whether the desired safety level is achieved.

Safety-related ratings of a two-channel application		
Highest safety integrity level to EN 62061:2010	SIL3	
Highest safety integrity level to IEC 61508:2010	SIL3	
Highest performance level to EN ISO 13849-1:2015	Cat. 3/PL e	
Hardware fault tolerance (HFT) in two-channel application (IEC 61508:2010/EN ISO 13849-1:2015)	1 (a fault of the application need not cause the safeguard to fail)	
Safety-related ratings	Ambient temperature, 25 °C	Ambient temperature, 55 °C
Probability of failure on demand (PFD _{avg}), proof test interval: 10 years, (IEC 61508:2010) for two outputs (from fieldbus)	$5.52 \cdot 10^{-6}$ (0.55% of entire PFD _{avg} of 10^{-3} at SIL3)	$2.33 \cdot 10^{-5}$ (2.33% of entire PFD _{avg} of 10^{-3} at SIL3)
Probability of failure per hour (PFH), proof test interval: 10 years, (IEC 61508:2010) for two outputs (from fieldbus)	$1.28 \cdot 10^{-10}$ 1/h (0.13% of entire PFH of 10^{-7} at SIL3)	$5.53 \cdot 10^{-10}$ 1/h (0.56% of entire PFH of 10^{-7} at SIL3)
Probability of failure on demand (PFD _{avg}), proof test interval: 20 years, (IEC 61508:2010) for two outputs (from fieldbus)	$1.13 \cdot 10^{-5}$ (1.13% of entire PFD _{avg} of 10^{-3} at SIL3)	$5.03 \cdot 10^{-5}$ (5.03% of entire PFD _{avg} of 10^{-3} at SIL3)
Probability of failure per hour (PFH), proof test interval: 20 years, (IEC 61508:2010) for two outputs (from fieldbus)	$1.32 \cdot 10^{-10}$ 1/h (0.13% of entire PFH of 10^{-7} at SIL3)	$6.18 \cdot 10^{-10}$ 1/h (0.62% of entire PFH of 10^{-7} at SIL3)
Diagnostic coverage (DC) to EN ISO 13849-1:2015	98,42 %	96,78 %
Safe failure fraction (SFF)	99,36 %	98,90 %
Mean time to dangerous failure (MTTF _d) to EN ISO 13849-1:2015	100 years (calculated: 254 years)	100 years (calculated: 140 years)

4.8 Response Time

In a safety system, the total response time is made up of the following separate times:

- signal processing by sensor
- signal processing by the Kuhnke FIO Safety I/O module
- time of input data transfer across the EtherCAT bus between the Kuhnke FIO Safety I/O module and the safe PLC
- safe PLC program runtime
- time of output data transfer across the EtherCAT bus between the Kuhnke FIO Safety PLC and the Kuhnke FIO Safety I/O module
- signal processing by the Kuhnke FIO Safety I/O module
- signal processing by actuator

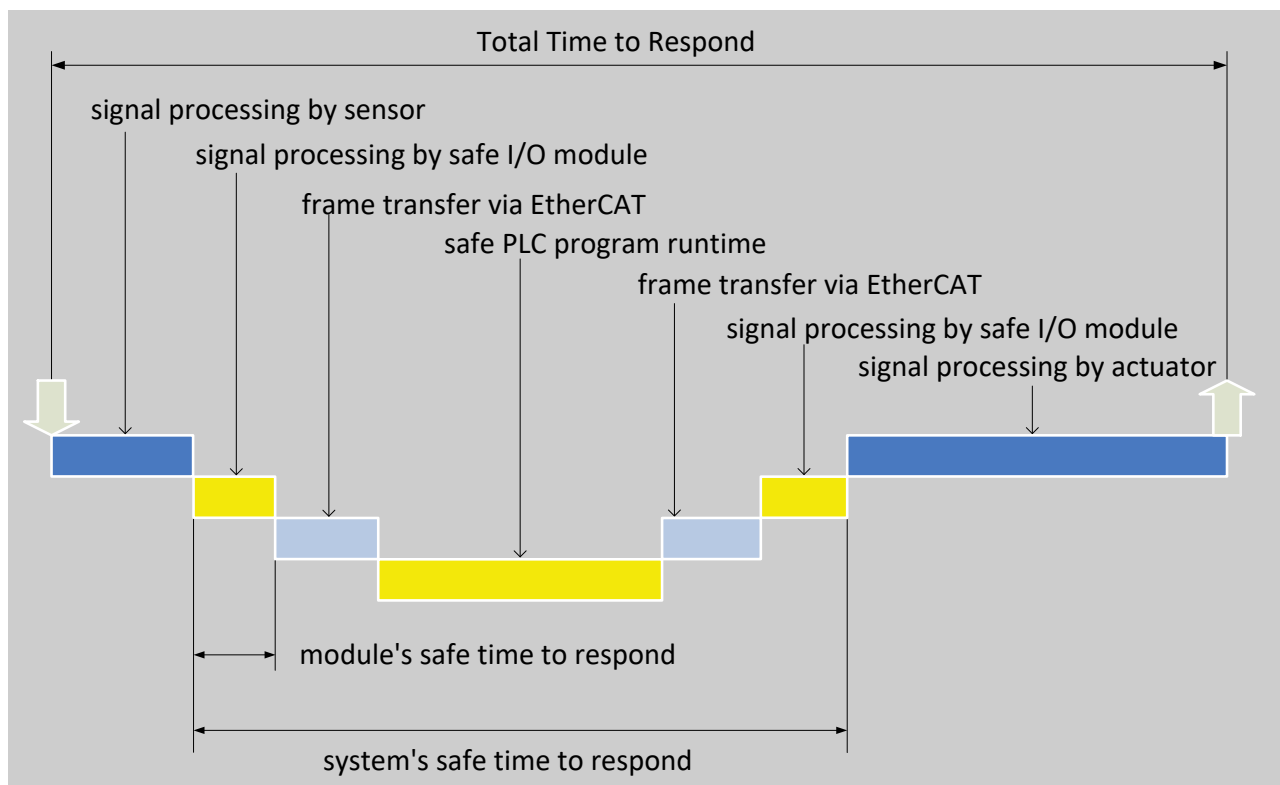

CAUTION

To calculate the safe response time, take account of the fieldbus runtimes and the Safety PLC's cycle time.

Avoid personal injury and damage to property

- ⇒ The fieldbus runtimes and the Safety PLC's cycle time must be taken account of to rate and calculate the safe response time.

As a general rule, a safe response time of **5 ms** may be assumed for the safe I/O module. This time ensures that the input and output signals will change and a safe state will be achieved.

The safe response time of digital inputs defines as the maximum time it takes before the FSoE frame is available on the EtherCAT bus after the signal of an input changes.

The safe response time of digital outputs defines as the maximum time it takes until the signal of a digital output changes after the EtherCAT module has received a FSoE frame.

Even if a fault occurs will the module be in a safe state before the safe response time is over. The following failure sources will provoke a change to the safe state:

- fault detected at the module inputs
- fault detected at the module outputs
- internal module fault (self-diagnosis)

**CAUTION**

Safety function pressure-sensitive mat requires a response time of 50 ms

Avoid personal injury and damage to property

- ⇒ The pressure-sensitive mat function achieves a set response time of 50 ms between a change in mat state and providing the information on the EtherCAT bus.

4.9 Dimensions

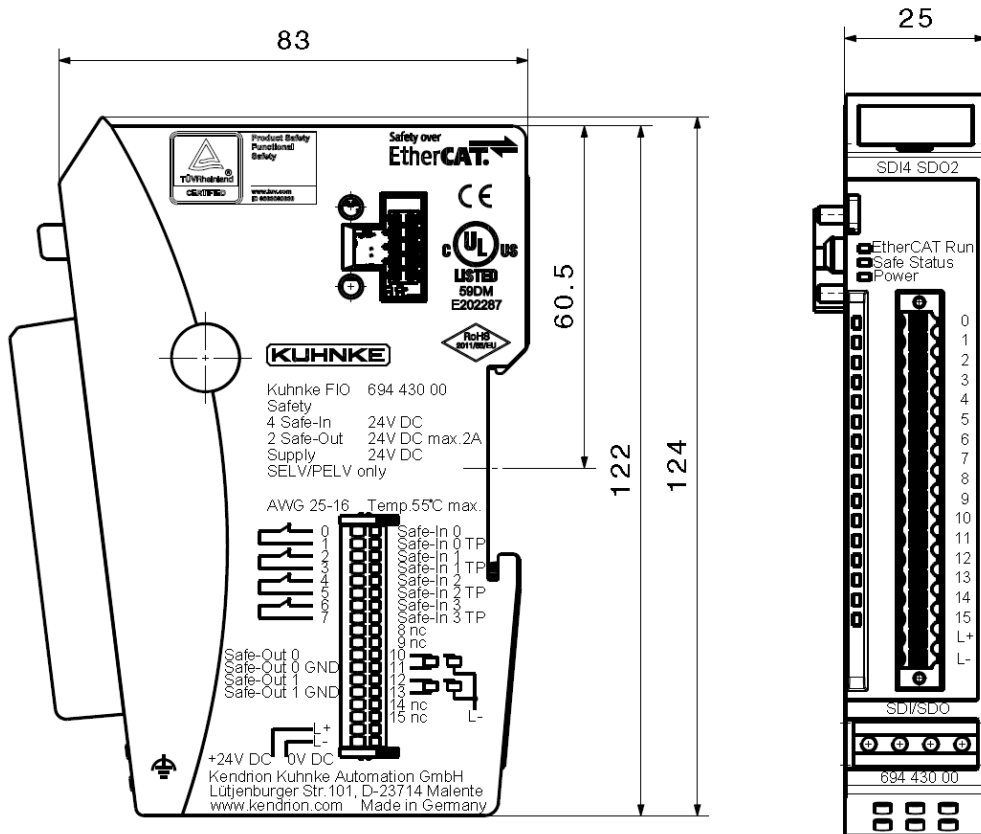

4.10 Transport and Storage

At times of transport and storage, protect Kuhnke FIO Safety I/O against inadmissible exposure such as mechanical stress, temperature, humidity and/or aggressive atmospheres. Transport and store Kuhnke FIO Safety I/O in its original packaging if possible.

Verify that the contacts are neither soiled nor damaged when consigning the unit to stock or re-packaging it. Keep and transport Kuhnke FIO Safety I/O in a container/packaging ensuring electrostatic discharge (ESD) compliance. Some parts of the units are sensitive to ESD and may be damaged if handled inappropriately. Thus, best transport practice is to place open assemblies in statically shielded transport bags with a metal coating which avoid contamination by amines, amides or silicone. When putting Kuhnke FIO Safety I/O into service and performing any maintenance, you should also take the appropriate precautions against electrostatic discharge.

	CAUTION
	<p>Electrostatic discharge Destruction of or damage to the unit.</p> <ul style="list-style-type: none"> ⇒ Transport and store FIO Safety I/O in its original packaging. ⇒ Ensure that the ambient conditions are as specified at all times during transport and storage. ⇒ Handle FIO Safety I/O in a well-earthed environment (persons, place of work, packaging). ⇒ Do not touch electrically conductive parts such as data contacts. Some of the electronic components may be destroyed if exposed to electrostatic discharge.

5 Construction and Functionality

5.1 Labelling and Identification

5.1.1 Imprinted Texts and Symbols

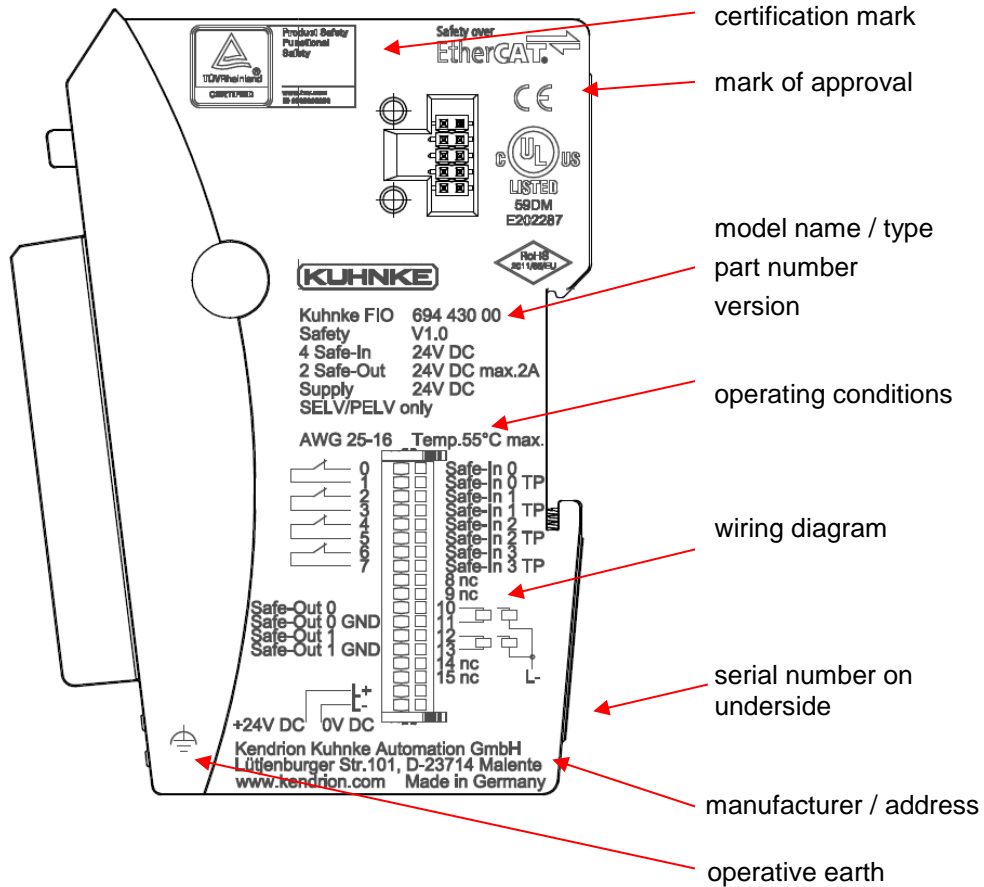

5.1.2 Serial Number

A label showing the serial number is affixed to the aluminium mount on the back of the module. The numerical code incorporates the production date and a serial number. Kendrion Kuhnke can use the numerical code to distinctly identify the model, software and hardware release date. It is a means of traceability.

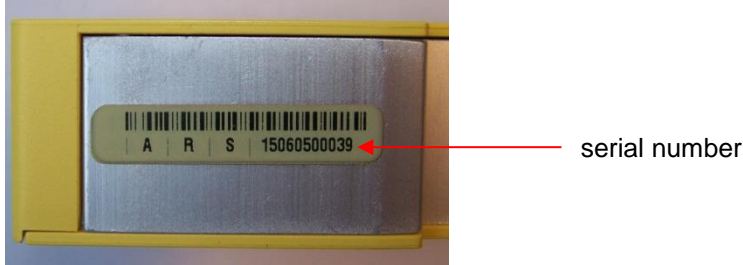

Make-up of serial number:

YY MM DD NNNNN

Example:

The unit shown above was manufactured on 15th June 2015 and has the serial number 00039.

15 06 05 00039

five-digit number of nth unit built on that day

production date as year month day

The serial number is also stored in object 1018 sub-index 4 and can be retrieved by SDO Transfer → 8.1.6 Identity Object 1018h.

5.2 Contents of Package

The FIO Safety I/Os package contains:

- FIO Safety I/O
- Module bus cover
- Connector

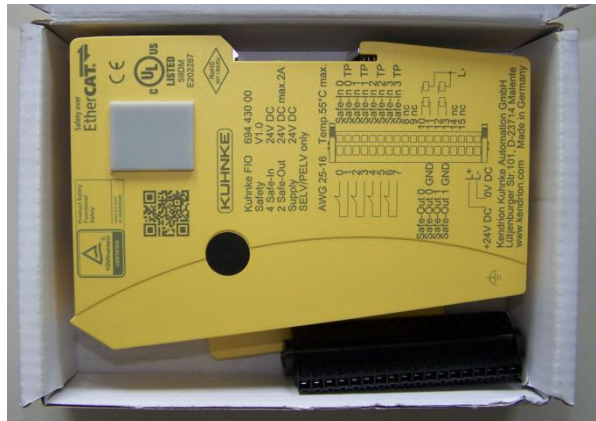
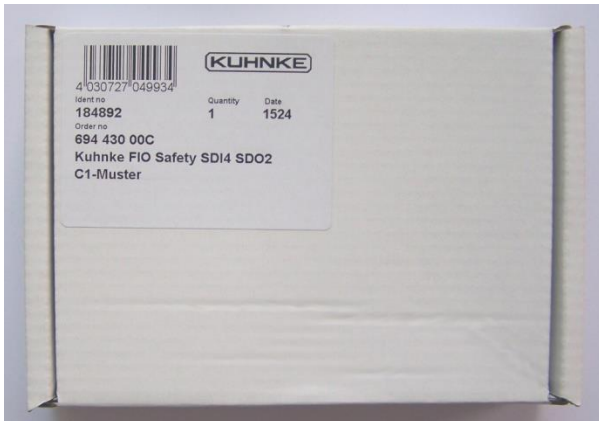

5.3 Connectors

5.3.1 E-bus and Module Lock

The system plugs and the module lock are located on the sides of Safety I/O. These contact pins interconnect the modules. They supply power to the module's electronic circuitry and transfer the EtherCAT signals. Verify that the end cap from the package is in place to protect the module bus connector on the last module at the right-hand side of a terminal unit against dirt.

The integrated module lock prevents the modules from coming apart under mechanical load or vibration.

	CAUTION
	<p><i>Interconnecting units of different design</i> <i>Damage to the unit's mechanical elements</i></p> <p>⇒ Use approved modules in a FIO network only.</p>

5.3.2 Spring-assisted Combi Plug X1

The spring-assisted combi plug is located at the front of FIO Safety I/O. The sensors and actuators and the module's power supply all attach to this connector.

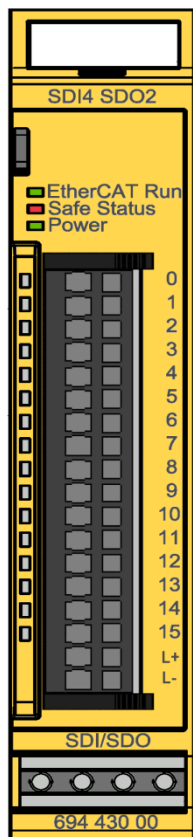

Connector X1		
Pin	Function	Signal
0	Safe-In 0	SI0
1	Safe-In 0 TP	SI0 TP
2	Safe-In 1	SI1
3	Safe-In 1 TP	SI1 TP
4	Safe-In 2	SI2
5	Safe-In 2 TP	SI2 TP
6	Safe-In 3	SI3
7	Safe-In 3 TP	SI3 TP
8	- Do not connect -	GND
9	- Do not connect -	GND
10	Safe-Out 0	SO0 +
11	Safe-Out 0 GND	SO0 -
12	Safe-Out 1	SO1 +
13	Safe-Out 1 GND	SO1 -
14	- Do not connect -	GND
15	- Do not connect -	GND
16	24 V supply to power element (outputs)	L+
17	GND	L-

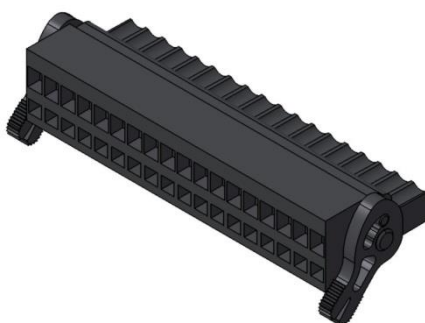



Figure: Single-row spring-assisted connector with releasing lever

	Note, information
	<p>Connection to the Kuhnke FIO Safety I/O module must be made by the spring-assisted connector from the package only. Refer to section → 6.2 Electrical Installation further down below for details on how to connect sensors and actuators.</p>
	CAUTION
	<p>Safe function jeopardised by cross-faults <i>Improper installation may cause malfunctions due to cross-faults at the contacts</i></p> <p>⇒ By design and if installed correctly, the spring-assisted connector prevents cross-faults at the contacts. Ensure a correct and technically perfect installation because cross-faults or shorts may jeopardise the module's safe function.</p>

5.3.3 Wiring Example

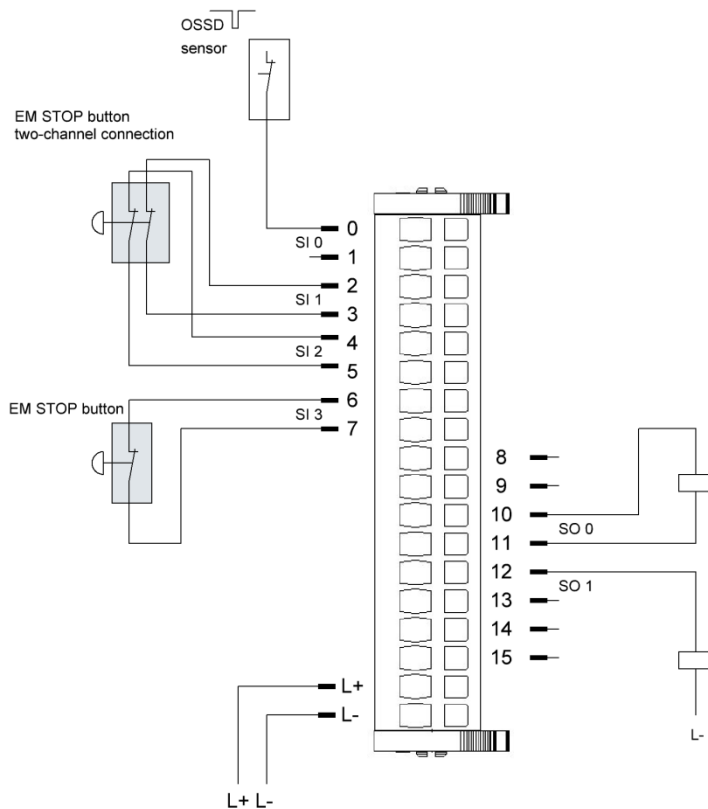

Figure2: Example of how to wire the inputs and outputs

The Kuhnke FIO Safety I/O module is intended to provide functional safety to industrial automation and to protect humans and machines in conformity with Machinery Directive 2006/42/EC.

It therefore supports the connection of many different safety-related sensors.

Examples:

- Single-channel and two-channel contact-type sensors such as EMERGENCY STOP switches
- Sensors with single and two-channel OSSD signals such as light grids
- Selector switches, safety mats and connecting blocks

Provided that the admissible maximum installed loads are not exceeded, resistive and inductive loads can be operated at the outputs, see section → 4.5.2

Safe Digital Outputs.

	Note, information
	Refer to section 7 Connection Examples for examples of how to connect various sensors and actuators.

	CAUTION
	Safe function jeopardised by cross-faults Improper installation may cause malfunctions due to cross-faults at the contacts
	⇒ When test pulses are enabled, the Kuhnke FIO Safety I/O module will detect cross-faults between the inputs / outputs and other signal lines of the same module. Note that you must prevent cross-faults with the security functions of other modules. You should therefore protect the signal lines and/or lay them separately.

5.3.4 I/O Supply

The I/O supply of the safe outputs and the associated test pulse outputs connects to terminals L+ and L-. The supply voltage is rated at 24 VDC. It is monitored.

The cord must have external protection against short circuit and overload triggering at max. 10 A.

Power to Kuhnke FIO Safety I/O may be supplied by PELV/SELV-ready 24 VDC power supply units to EN50178 / EN60950-1 only. This applies to both the system power supply → 6.2.3 System Power Supply and the I/O supply → 6.2.4 I/O Supply.

	CAUTION
	<p><i>Risk of fire by overload or overvoltage</i> <i>Damage to the unit</i></p> <ul style="list-style-type: none"> ⇒ Power to Kuhnke's FIO Safety I/O module may be supplied by PELV/SELV-ready 24 VDC power supply units to EN50178 / EN60950-1 only. ⇒ The maximum voltage supplied must not exceed 33 V even in case of an error. ⇒ The cord must have external protection against short circuit and overload triggering at max. 10 A.

	CAUTION
	<p><i>Module defect by reversing the polarity of the voltage supplied</i> <i>Although Kuhnke's FIO Safety I/O module is reverse polarity-proof, reversing the polarity will still put considerable stress on the electronic circuitry and may cause module defects!</i></p> <ul style="list-style-type: none"> ⇒ Avoid a reversal of polarity.

In case the supply of power is interrupted, drops or increases beyond the rated limits, the module will change to the safe state and output the appropriate error code to the service block → 6.5.7 Error Codes.

Refer to section 6.5 Diagnosis for further details on how the module responds to a non-conforming supply of power.

5.4 Indicators and Controls

5.4.1 LED "EtherCAT Run"

LED "EtherCAT Run" indicates the state of EtherCAT communication.

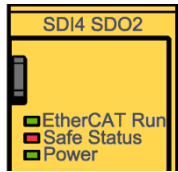

LED "EtherCAT Run"		
LED	State	Explanation / State
Off	Init	Initialising, no data exchange
Off/green, 1:1	Pre-Op	Pre-operational, no data exchange
Off/green, 5:1	Safe-Op	Safe operation, inputs readable
Green, on	Op	Operational, unrestricted data exchange

5.4.2 LED "Safe Status"

Duo LED safe "status" indicates the state of the module regarding its safety function.

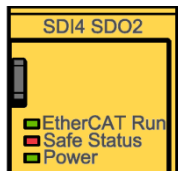

LED "Safe Status"		
LED	State	Explanation
Green, on	OK	Safety I/O provides safe functionality
Red, on	Error	Safety I/O in fail-safe state

5.4.3 LED "Power"

LED "Power" indicates the state of the power supply to Kuhnke's FIO Safety I/O module.

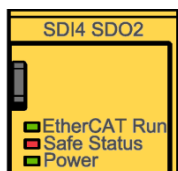

LED "Power"	State	Explanation
Off		No power supplied to the module.
Green, on	OK	Operating voltage supplied to the module.



Information

Kuhnke's FIO Safety I/O module feature a voltage watchdog for the 24 VDC supply voltage. It enables the module's safe state when a voltage is out of the specified range.

5.4.4 LEDs "Channel"

The "Channel" LEDs are allocated to the module's terminals. Every group of 2 LEDs indicates the state of the associated functional unit of output and/or input.

Safe digital inputs SI 0 .. SI 3 in conjunction with test pulse outputs

LEDs "Channel"; Safe digital inputs SI 0 .. SI 3				
LED position	Channel	Function	LED	Explanation
0	Input SI 0	SI0 state	Off	No valid input signal on channel 0, logical "0"
			Green	24 VDC supplied to channel 0, logical "1"
1		SI0 diagnosis	Off	Normal operation
			Red	External power supply or cross-fault
2	Input SI 1	SI1 state	Off	No valid input signal on channel 1, logical "0"
			Green	24 VDC supplied to channel 1, logical "1"
3		SI1 diagnosis	Off	Normal operation
			Red	External power supply or cross-fault
4	Input SI 2	SI2 state	Off	No valid input signal on channel 2, logical "0"
			Green	24 VDC supplied to channel 2, logical "1"
5		SI2 diagnosis	Off	Normal operation
			Red	External power supply or cross-fault
6	Input SI 3	SI3 state	Off	No valid input signal on channel 3, logical "0"
			Green	24 VDC supplied to channel 3, logical "1"
7		SI3 diagnosis	Off	Normal operation
			Red	External power supply or cross-fault



Information

- The red "diagnosis" LEDs are disabled if the safe digital inputs are used without the safe digital test pulse outputs.
- The green "status" LEDs of the inputs will indicate the presence of a 24 VDC signal at an input even if that input has not been set up in the configuration.

Safe digital outputs SO 0 and SO 1

LEDs "Channel"; Safe digital outputs SO 0 and SO 1				
LED position	Channel	Function	LED	Explanation
10	Output SO 0	Status	Off	No output signal at output 0, logical "0"
			Green	Output signal at output 0, logical "1"
11		Diagnosis	Off	Normal operation
			Red	External power supply or cross-fault
12	Output SO 1	Status	Off	No output signal at output 1, logical "0"
			Green	Output signal at output 1, logical "1"
13		Diagnosis	Off	Normal operation
			Red	External power supply or cross-fault

5.5 Operating Software

The FSoE master's configuration tool is used for operation and configuration . Refer to the FSoE master user guide for further information and details.

6 Installation and Operation

Before installing the Kuhnke FIO Safety Module, verify that it has been transported and stored at the ambient conditions specified in sections → 4.10 Transport and Storage and → 4.5 Technical Data.

Module operation is subject to the service conditions specified in section → 4.5 Technical Data.

	CAUTION
	<p><i>Inappropriate operation</i> <i>Malfunction of Kuhnke's FIO Safety I/O module</i></p> <ul style="list-style-type: none"> ⇒ Only persons qualified for dealing with safety matters are allowed to add, replace and put Safety I/O Modules into operation. ⇒ Before installing, servicing or putting Kuhnke FIO Safety into service, please also read the safety information in the preface of this document. ⇒ Before putting the unit into service, verify that all safety functions work as specified.

6.1 Mechanical Installation

Environment of installation

Protect KUHNKE FIO I/O against inadmissible contamination. Do not allow the units to contaminate more than specified for degree II in IEC 60664-3.

Whereas an enclosure providing IP 54 protection (e.g. an appropriate control cabinet) ensures that degree of contamination II is complied with, please consider that operation under condensing humidity is NOT allowed.

	WARNING
	<p><i>Potentially hazardous failures due to contamination</i> <i>Contaminations more severe than those described for degree of contamination II of IEC 60664-3 may cause potentially hazardous failures.</i></p> <ul style="list-style-type: none"> ⇒ Do ensure that the operating environment complies with at least IP 54, e.g. by installing the unit in a suitable control cabinet.

6.1.1 Mounting Position

Kuhnke FIO I/Os mount on 35 mm x 7.5 mm rails to DIN EN 50022. Mount with rail horizontally with the modules' multiple socket connectors pointing away from the wall. To ensure that enough air gets in through the ventilation slots, leave at least 20 mm to the top and 35 mm to the bottom of a module and any adjacent devices or cabinet surfaces. Leave at least 20 mm of lateral distance to third-party units and cabinet surfaces.

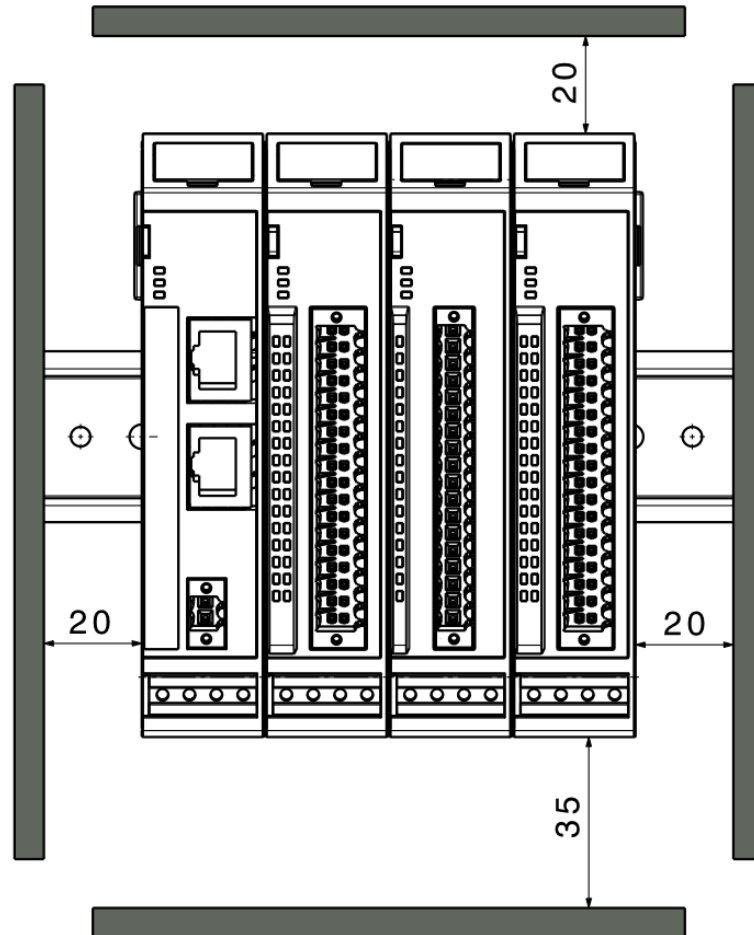

Order of modules in multi-FIO systems

	NOTE
	<p>Order of modules in multi-FIO systems</p> <p><i>In order to ensure that the entire FIO system works properly, arrange the FIO modules by their specific E-bus load, placing the modules with the highest E-bus load immediately next to the head module (bus coupler or controller). Take account of the head module's maximum bus load. If possible, place the Kuhnke FIO Safety I/O module immediately next to the head module.</i></p>

6.1.2 To Snap on a Single Module

- ⇒ Push up the module against the mounting rail from below, allowing the metal spring to snap in between mounting rail and mounting area as illustrated.
- ⇒ Push the top of the module against the mounting wall until it snaps in.

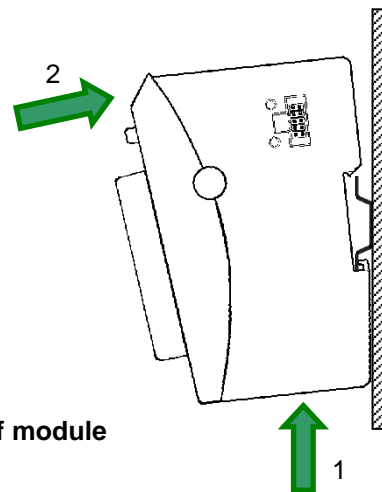



Figure 3: Rail mounting of module

6.1.3 To Interconnect Two Modules

- ⇒ After snapping on the first module to the rail, snap on the second module about 1 cm away towards the right of the first module.
- ⇒ Push the second module along the rail towards the first module until you hear the locking device snap in. Correctly mounting the modules is the only way of ensuring that the system works properly.
- ⇒ To prevent inadmissible contamination, mount the cover of the module bus connectors on the rightmost module of the FIO system.

	CAUTION
	<p>Short circuit fault of module bus contacts</p> <p><i>A short of the module bus contacts may cause the communication with the safe module to fail.</i></p> <ul style="list-style-type: none"> ⇒ Verify that the cover of the module bus connector is mounted on the rightmost module of the FIO system.

6.1.4 To Disconnect Two Modules

- ⇒ Push down the unlock button (see Figure 4) of the module that you wish to disconnect from the module to the left of it.
- ⇒ Push both modules away from one another until they are about 1 cm apart.

6.1.5 To Take Down a Single Module

- ⇒ Push the module up and against the metal spring located on the underside of the rail guide.
- ⇒ Tip the module away from the rail as shown in the illustration.
- ⇒ Pull the module down and out of the mounting rail.

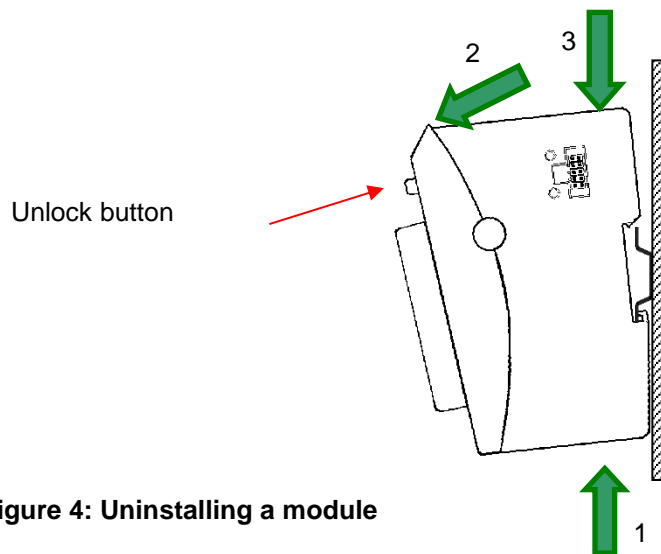

Figure 4: Uninstalling a module

6.2 Electrical Installation

6.2.1 Earth

Connect the Kuhnke FIO modules to earth by attaching the metal housing to functional earth. Since the functional earth connector dissipates HF currents, it is of utmost importance for the module's noise immunity. HF interference is dissipated from the electronics board to the metal housing. The metal housing therefore needs to be suitably connected to a functional earth connector. You would normally ensure that the connection between the module housing and the DIN rail as well as the connection between the DIN rail and the control cabinet conducts well and that the control cabinet is properly connected to earth. In exceptional cases, you may connect earth directly to the front of the module.

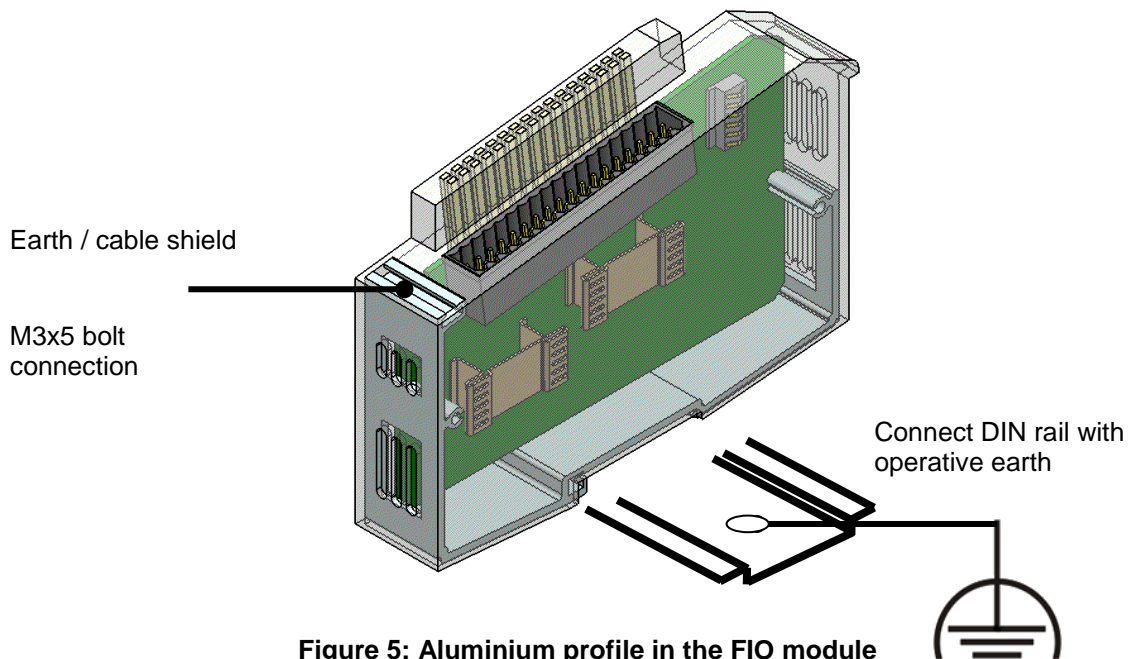

Figure 5: Aluminium profile in the FIO module

	<p>Information</p>
	<p>Earth wires should be short and have a large surface (copper mesh). Refer to http://de.wikipedia.org/wiki/ground_(electronics) for further details</p>
	<p>Note</p>
	<p>When installing production or other lines, measure the earth potential of the DIN rail as specified in the applicable guidelines (earth test to VDE 0100). Measuring the earth potential must show that every protective earthing and operational earthing is within the boundaries set by the applicable standards. Also consider the repeat testing frequency resulting from the hazard assessment.</p>

6.2.2 Module Interconnection

The FIO modules electrically connect by completely pushing the modules together. This automatically connects the modules to both the EtherCAT bus and the system power supply. If possible, place the Kuhnke FIO Safety I/O module immediately next to the head module. Refer to section → 6.1 Mechanical Installation for details about how to interconnect two modules.

Please note that the maximum current supplied by the bus coupler limits the number of FIO modules you may connect to a single block.

6.2.3 System Power Supply

A system connector supplies the Kuhnke FIO Safety I/O system with system power from an upstream bus coupler or a compact controller. This system power supply is used for the analysis circuitry and for bus communication only.

	Note, information
	<i>Please take note of the system power supply details provided in the operating instructions of the upstream bus couplers or compact PLCs as well as the additional system power supply instruction in this user guide.</i>

	WARNING
	<p>Potentially hazardous failures due to wrong voltages supplied</p> <p><i>Supplying the wrong voltages may damage or destroy the unit and may provoke potentially hazardous failures.</i></p> <p><i>Preventive measures:</i></p> <ul style="list-style-type: none"> ⇒ Only use PELV/SELV-ready power supply units to EN50178 or EN60950-1 to supply 24 VDC to bus couplers or compact PLCs that any Kuhnke FIO Safety I/O modules are connected to. ⇒ Only use the GND terminal to connect the power supply unit to earth (PELV system). Do not use earthing variants that connect earth to +24V. ⇒ Remember that, even in case of a fault, a maximum voltage of $U_{max.} < 33 \text{ V}$ may be supplied to these assemblies. ⇒ To ensure that there is as little interference as possible, install a central power supply point and establish a star topology of as short wires as possible between the central point and the block of FIO modules.

6.2.4 I/O Supply

The power supplied to the safe outputs and the associated test pulse outputs connects to terminals L+ and L-. The supply voltage is rated at 24 VDC. It is monitored. In case of overvoltage ($> +20\%$) and low voltage ($> -15\%$) alike, the module changes to its safe state.

	WARNING
	<p>Potentially hazardous failures due to wrong voltages supplied</p> <p><i>Supplying the wrong voltages may damage or destroy the unit and may provoke potentially hazardous failures.</i></p> <p><i>Preventive measures:</i></p> <ul style="list-style-type: none"> ⇒ Only use PELV/SELV-ready power supply units to EN50178 or EN60950-1 to supply 24 VDC to the I/Os of FIO Safety I/O. ⇒ Fuse the I/O power supply of FIO Safety I/O with max. 10 A. ⇒ Only use the GND terminal to connect the power supply unit to earth (PELV system). Do not use earthing variants that connect earth to +24V. ⇒ Remember that, even in case of a fault, a maximum voltage of $U_{max.} < 33 \text{ V}$ may be supplied to these assemblies. ⇒ Do not reuse but replace units operated on voltages $> 33 \text{ V}$. ⇒ To ensure that there is as little interference as possible, install a central power supply point and establish a star topology of as short wires as possible between the central point and the block of FIO modules.

I/O power supply fusing

The cord must have external protection against short circuit and overload triggering at max. 10 A, min. 60 v.

	WARNING
	<p><i>Risk of fire due to short circuit!</i> <i>A short circuit in the module or the power supply lines may cause the system to overheat or provoke a fire.</i></p> <p><i>Preventive measures:</i></p> <ul style="list-style-type: none">⇒ Install a fuse triggering at max. 10 A.

6.2.5 Sensor and Actuator Power Supply

All sensors and actuators of the FIO Safety I/O system supplied with power from an external source must still run on safe low operating voltage (SELV/PELV). This power may also be fed to the I/Os of the FIO Safety I/O module.

	WARNING
	<p><i>Potentially hazardous failures due to wrong voltages supplied to sensors and actuators</i> <i>Supplying the wrong voltages may damage or destroy the unit and may provoke potentially hazardous failures.</i></p> <p><i>Preventive measures:</i></p> <ul style="list-style-type: none">⇒ Only use PELV/SELV-ready power supply units to EN50178 or EN60950-1 to supply 24 VDC to sensors and actuators connected to the Kuhnke FIO Safety I/O modules.⇒ Only use the GND terminal to connect the power supply unit to earth (PELV system). Do not use earthing variants that connect earth to +24V.⇒ Remember that, even in case of a fault, a maximum voltage of $U_{max.} < 33 \text{ V}$ may be supplied to the sensors and actuators.⇒ Do not reuse but replace units operated on voltages $> 33 \text{ V}$.⇒ To prevent that voltages are carried over, provide a low-impedance connection between the chassis ground of the unit supplying power to the sensors and actuators and the unit supplying 24 VDC to the I/Os of the Kuhnke FIO Safety I/O module.

6.2.6 Power Supply Wiring Example

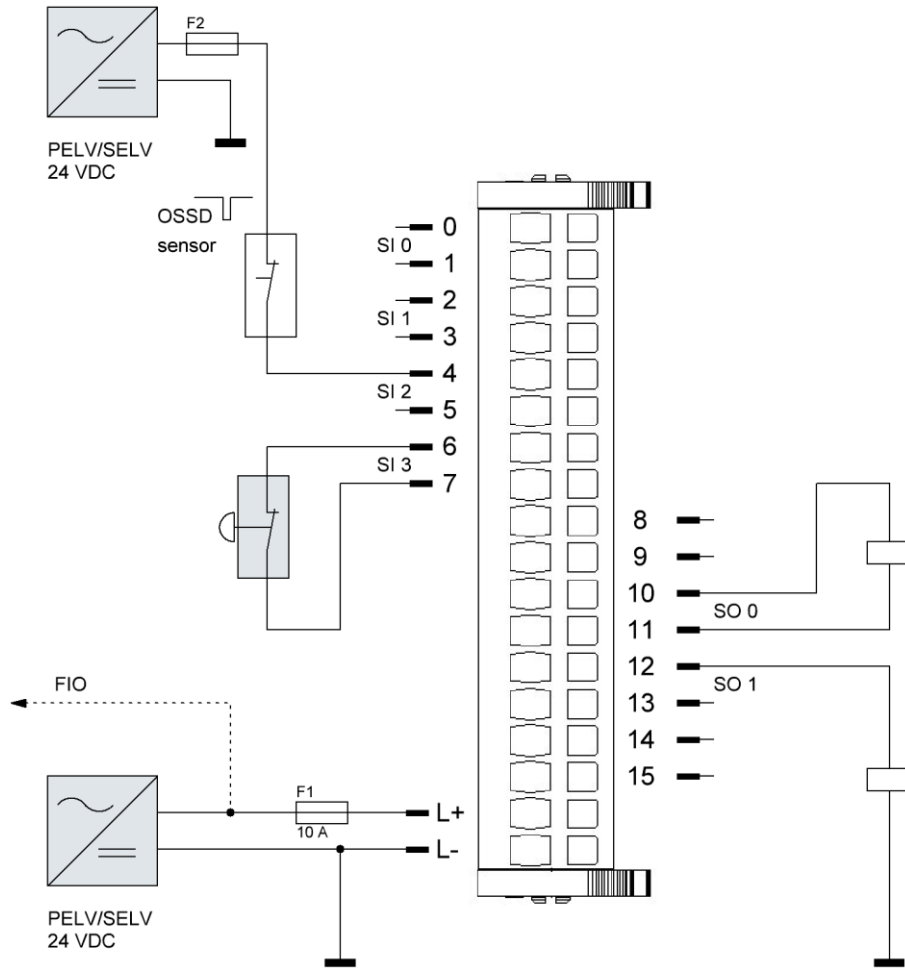

6.2.7 Sensor Connection

	<p>CAUTION</p>
	<p>Consideration of the parameterization</p> <p><i>For single-channel applications (inputs and outputs), the test pulse frequency should be adapted to the application. It must be ensured that in applications in which a frequent change of state occurs, the test pulse frequency is selected at least 100 times greater than the state change time of the application.</i></p> <p>⇒ See FSoE Parameters 6.3.2</p>

Single-channel contact-type sensor

The inputs of single-channel contact-type sensors work entirely separate from one another. Wiring should take account of the fact that every input signal is allocated to the test pulse output. Use the configuration to separately enable each of the inputs → 6.3.3 Input Parameters.

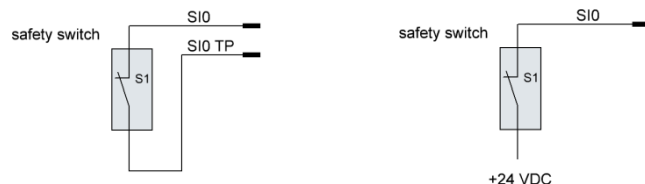

Analysis of states

The module checks the states of the inputs and transfers the result to the safe control unit.

The process data image of a safe input transfers

- "0" if a "0" signal is supplied to the input **or** if an error has been detected;
- "1" if a "1" signal is supplied to the input **or** if an error has not been detected.

To disable the clock signals

If the appropriate parameter disables the clock signals, you may supply 24 VDC to the sensor from an external power source. If so, please remember that disabled test pulse outputs prevent the detection of faults in the external wiring.

	<p>WARNING</p>
	<p>Non-detection of a corrupt external wiring when test pulse outputs are disabled</p> <p><i>Unsafe machine state, safety hazard</i></p> <p>⇒ Always use the correct and enabled test pulse output to supply power to contact-type sensors.</p>

	<p>WARNING</p>
	<p>External filter with direct connection of the module to the 24V supply</p> <p><i>It is generally advisable to use the safe inputs with the module-specific test pulse outputs or OSSD outputs from external sensors. A direct connection of the safe inputs is only allowed for a 24V supply filtered in accordance with EN 61326-3-1 (interference level for surge, burst and conducted RF interference for I / O signals with direct mains supply).</i></p>

Refer to section → 7.1 Safety Function with Single-channel Input for connection examples.

Two-channel contact-type sensors

Two-channel contact-type sensors allow different inputs to be connected to the test pulse output of a two-channel sensor. A software module of the safe control unit provides the required analysis of the input signals.

The software can be used to interconnect any of the safe inputs. Wiring should take account of the fact that every input signal is allocated to the test pulse output. You must use the configuration to enable the safe inputs you use → 6.3.3 Input Parameters.



The process data image of a safe input transfers

- "0" if a "0" signal is supplied to the input **or** if an error has been detected;
- "1" if a "1" signal is supplied to the input **or** if an error has not been detected.

Refer to section → 7.2 Safety Function with Two-channel Input for connection examples.

Multi-channel contact-type sensors

Multi-channel switches such as mode selectors or "toggle"-type switchgear connect to several safe inputs only using test pulse output SI0 TP to provide the correct function. You must use the configuration to enable the safe inputs you use and parameter "External Inputs" to choose the mode selector function → 6.3.3 Input Parameters and 7.4 Mode Selector, Rotary Table.

Switches with 2, 3 or 4 channels can be analysed.

safety mode selector switch

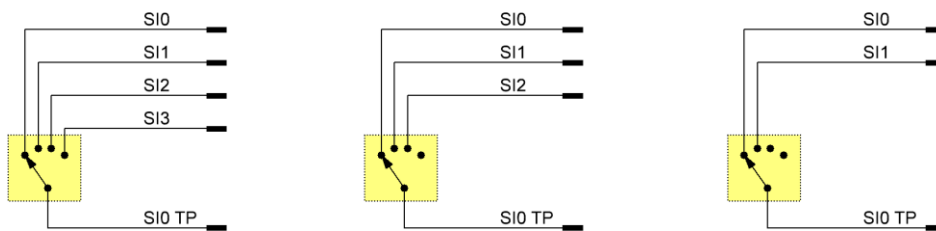

Allocation of safe inputs for the mode selector function

No. of channels	Safe inputs used	Clock signal
4	SI0, SI1, SI2, SI3	SI0 TP
3	SI0, SI1, SI2	SI0 TP
2	SI0, SI1,	SI0 TP

Safe inputs you do not use are available for other functions.

PLCopen module "Mode Selector" or a similar module of the safe control unit is used for multi-channel analysis. The achievable category to EN ISO 13849 depends on the switching device's error model (e.g. mode selector) and must needs be analysed in conjunction with the PLCopen module's error detection.

Refer to section → 7.4 Mode Selector, Rotary Table for connection examples.

	NOTE
	<p>Test pulse output</p> <p><i>In mode selector mode, test pulse output TP0 can be set to "0". However, this will not affect the test pulse as such since, in mode selector mode, the test pulse always runs at maximum frequency.</i></p>

	NOTE
	<p>Time discrepancy in mode selector/rotary table mode <i>A set time discrepancy of 100 ms has been implemented for signals missing at the inputs when changing to mode selector mode.</i></p>

Electronic sensors, OSSD sensor

The OSSD sensor provides the fault detection function when connecting an OSSD sensors. Depending on the sensor's functionality, the retrieval of signals is able to detect cross-faults between the 24 V power supply and earth as well as cross-faults between the sensor signals.

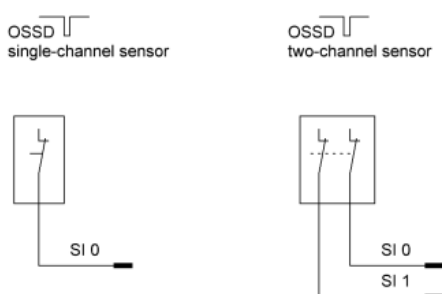

Wiring of sensors providing OSSD signals

Two-channel sensors delivering OSSD signals can be connected to any safe input of the Kuhnke FIO Safety I/O module. A software module of the safe control unit provides the required allocation and analysis of the input signals.

Sensors with OSSD signals do not support the module's test pulses. You must therefore set the input channels to "Test pulse duration =0" → 6.3.3 Input Parameters.

To prevent voltages from being carried over, provide a low-impedance connection between the chassis ground of both the sensor and the Kuhnke FIO Safety I/O module.

Pressure-sensitive mat, bumper

Pressure-sensitive mats and bumpers are used to safeguard the floor around a machine. The mats are placed in the danger zone and make the control unit change to its safe functional state whenever pressure is exerted on them. In this case, a high signal is sent from both inputs.

Kuhnke's FIO Safety I/O module supports four-wire mats. Two safe digital inputs and the associated test pulse output are used for one mat / bumper.

You must use the configuration to enable the safe inputs you use and parameter "External Inputs" to choose the bumper function → 6.3.3 Input Parameters.

You may use up to two mat channels.

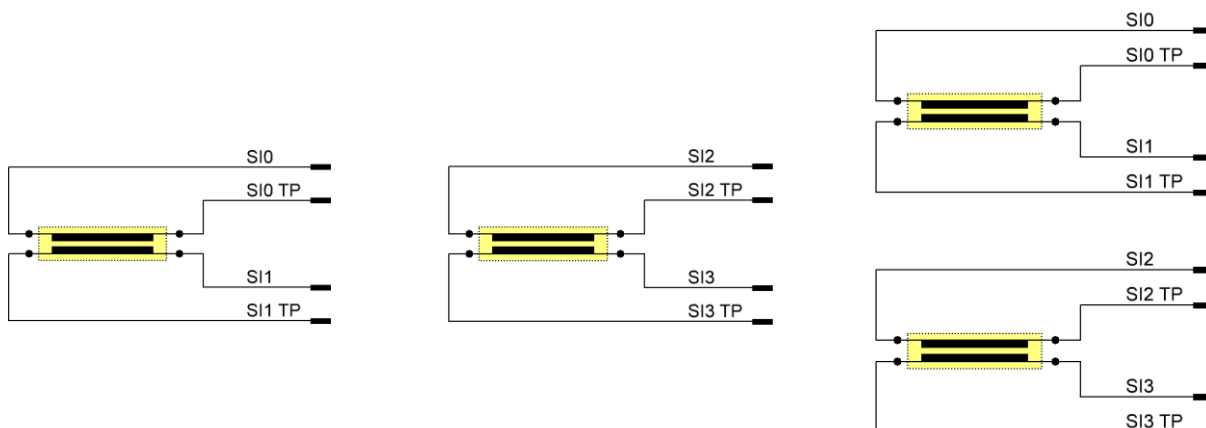



Allocation of safe inputs for the bumper function			
Parameter "External Inputs"		Safe inputs used	Safe inputs used
Bit 7	Bit 6		
0	0	bumper function not selected	none
0	1	SI0, SI1,	SI0 TP, SI1 TP
1	0	SI2, SI3	SI2 TP, SI3 TP
1	1	SI0, SI1, SI2, SI3	SI0 TP, SI1 TP, SI2 TP, SI3 TP

Safe inputs you do not use are available for other functions. PLCopen module "SF_ESPE" or a similar module of the safe control unit is used for mat / bumper analysis. The achievable category to EN ISO 13849 depends on the switching device's error model and must needs be analysed in conjunction with the PLCopen module's error detection.

Refer to section → 7.5 Safety Mats, Connecting Blocks and Bumpers for connection examples.

	NOTE
	<p><i>Lay the feed lines of pressure-sensitive mats and bumpers together</i> <i>In order to avoid influences and malfunctions due to EMC effects, lay the four wires (e.g. SI0, SI0 TP, SI1, SI1 TP) together.</i></p>

	CAUTION
	<p><i>"Short circuit in mat" fault is not detected</i> <i>The safe I/O module fails to detect a short circuit between the mat contacts. This is interpreted as the mat being actuated. You must also verify that the safeguard is wired correctly.</i></p> <p>⇒ Periodically check that the mat is working properly.</p>

	CAUTION
	<p><i>Safety function pressure-sensitive mat requires a response time of 50 ms</i> <i>Avoid personal injury and damage to property</i></p> <p>⇒ The pressure-sensitive mat function achieves a response time of 50 ms between a change in mat state and providing the information on the EtherCAT bus.</p>

6.2.8 Actuator Connection

	NOTE
	<p><i>Faults at the outputs provoke a change to the safe state</i> The outputs are protected against overload and short circuit, see section → 4.5.4 Safe Digital Outputs for details. Overload and short circuit cause the module to change to its safe state. The module responds in the same way to external power fed to and cross-faults at the outputs.</p>

Resistive loads, inductive loads and resistive loads with some capacitive fractions can be connected to the digital power outputs of the FIO Safety I/O module. They also support signal lamps dissipating resistive power of up to 10 W.

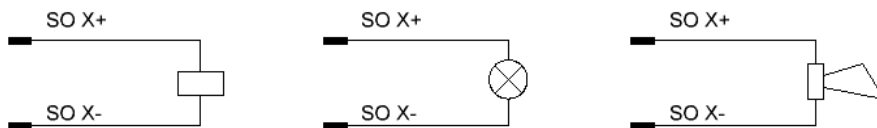

Actuators with external GND reference

Provided that the configuration is taken account of, actuators with external GND reference can be connected to the Kuhnke FIO Safety I/O module.

Switching of inductive loads

If the internal free wheel circuit is enabled, the digital power outputs of the FIO Safety I/O module can be used to operate inductive loads. The graph below illustrates the maximum inductance of the load vs. the load current.

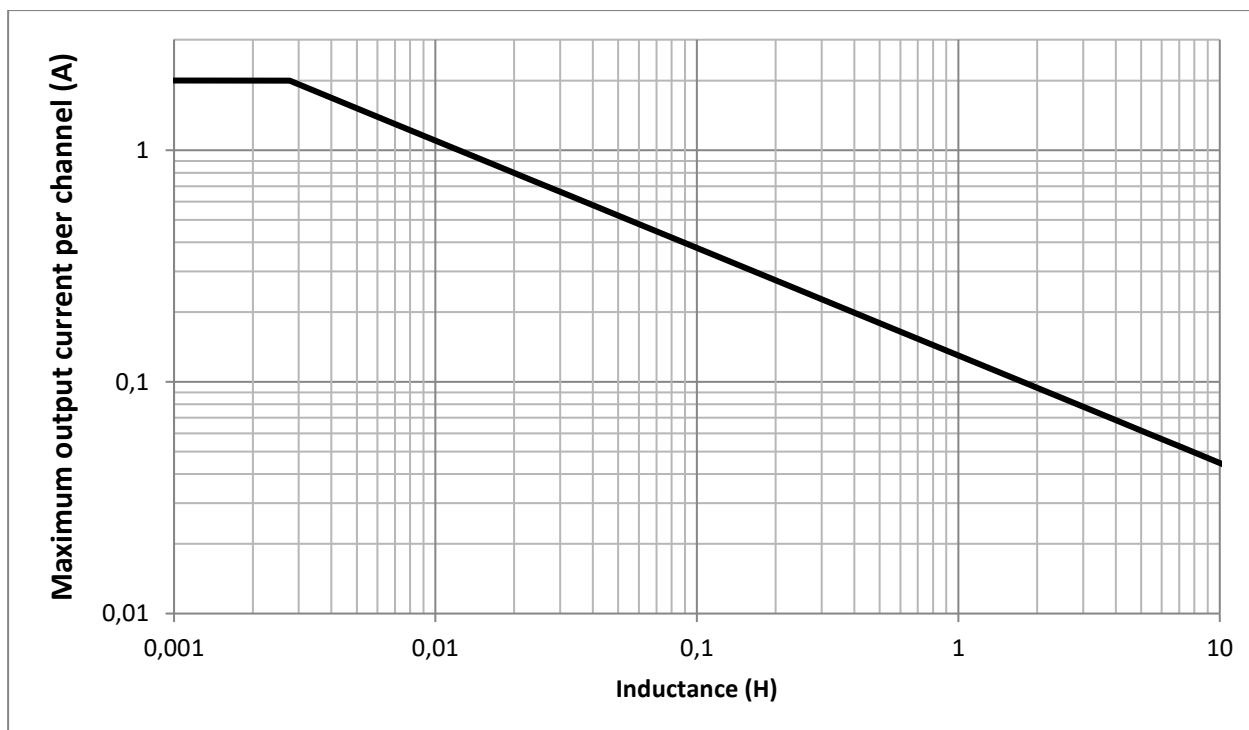

	NOTE
	<p>Defect caused by thermal overload due to excessive inductance! <i>Setting the inductance and the load current to higher than the specified values may thermally destroy the digital power output. Destroying the digital power output may cause the safety function to fail.</i></p>

Use an external free wheel circuit if the external load exceeds the specified inductance limits.

External free wheel circuit

	NOTE
	<p>Take heed of the perturbation of the external free wheel circuit</p>

Depending on the actual safety function, it may or may not be affected by the external free wheel circuit which the safety assessment must take account of.

An external free wheel circuit will transduce the magnetic energy when turning off the inductive load.

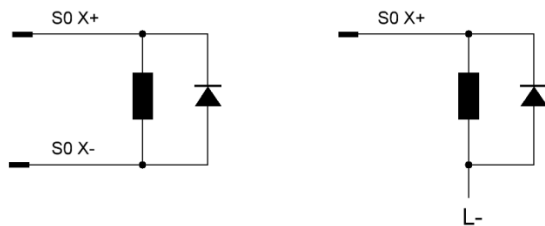

Verify that the external free wheel circuit is designed to withstand the ensuing dissipation heat.

When connecting the inductive load to the outputs, be sure to limit the negative voltage of the external free wheel element you choose to anything smaller than -30 V because the digital output will otherwise transduce the magnetic energy to heat.

NOTE

Note the heat dissipated by the external free wheel element!
 If you choose the correct external free wheel element, this element instead of the safe I/O module will transduce the magnetic energy when turning off the inductive load.
 Verify that the external free wheel circuit is designed to withstand the ensuing dissipation heat.

Switching of digital inputs

Digital inputs of I/O modules can be switched by the module's SO X+ outputs. Verify that you have enabled parameter "extGroundOutput" of the output you use. Output test pulse configuration must consider the input capacitance of the input to be actuated. See the section on the switching of capacitive loads below.

To ensure that the test pulses of the digital power outputs are filtered properly when the safe digital inputs of the Safety IO module are used, the inputs' configurable filters should be set to the same test pulse duration (parameter "Test pulse duration") as the digital power output.

Switching of capacity loads

Switching of capacitive loads must take account of the limits below described with reference to the output current and the test pulse length.

Test pulses cyclically test the module's digital outputs. If you connect a capacitive load to the digital power output, you may have to modify the test pulse duration. A test pulse length not adapted to the load may cause the module to change to its safe state.

The outputs support loads connected to SOX+ and SOX- as well as to SOX+ and an external GND potential. Different maximum capacitive loads apply to both configurations because they are built around a different internal composition of the outputs. Every output supports a maximum capacitive load of 2.2 µF.

Output capacity of actuators with external GND reference or digital inputs to SOX+		
Test pulse length	Output current 2 mA	Output current 20 mA
500 µs	50 nF	300 nF
1000 µs	110 nF	600 nF
1500 µs	175 nF	1000 nF

Output capacity of actuators with GND reference connected to SOX+ and SOX-		
Test pulse	Output current 2 mA	Output current 20 mA

length		
500 μ s	17 nF	310 nF
1000 μ s	48 nF	620 nF
1500 μ s	77 nF	950 nF

Total current derating

	CAUTION
	<p>Do not operate the FIO Safety I/O module out of the specified range</p> <p><i>Faults by component overload</i></p> <ul style="list-style-type: none"> ⇒ Operate the module under the ambient conditions listed in section Technical Data only while observing the derating of the outputs.

The maximum rated total current of the output module varies with the I/O module's ambient temperature. Refer to the diagram below for the resulting total current.

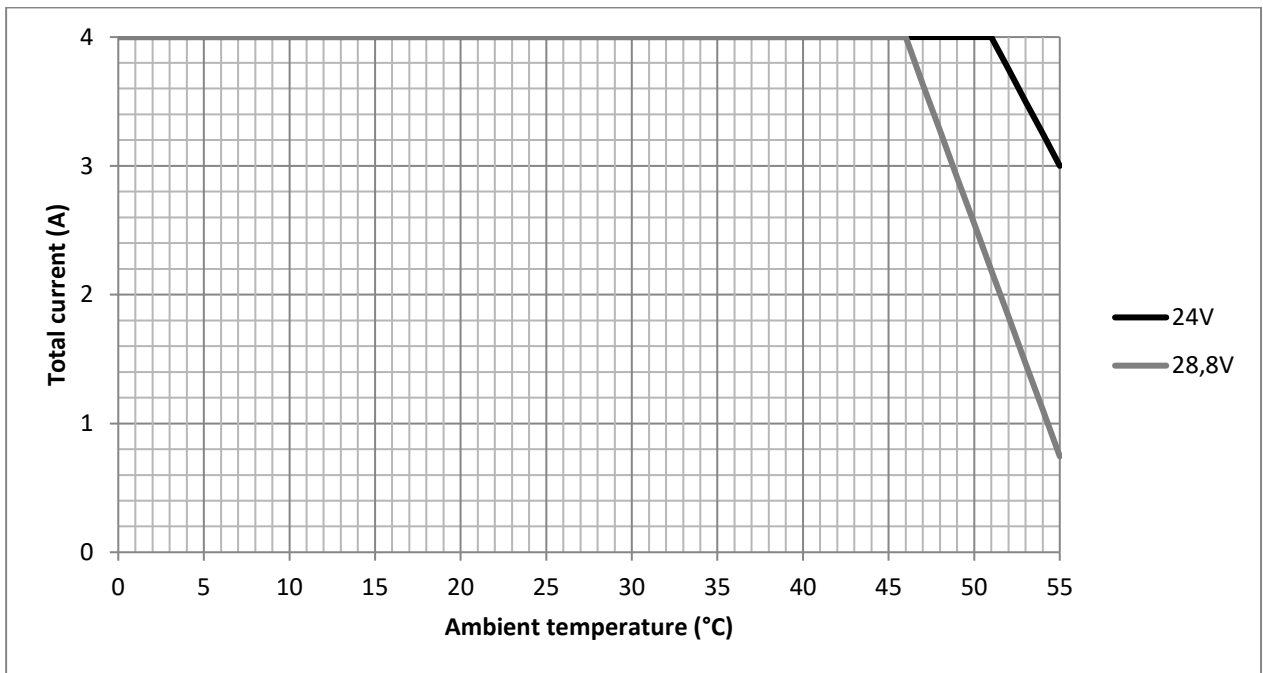

The output current derating shown on the graph was measured under free convection in a typical installation (I/O modules on the left and right, 50% duty cycle, identical supply voltage).

6.2.9 Multiple socket connector (MSC)

The multiple socket connector features tension springs which make wiring quick and easy. Use the unlock button to easily disconnect the wires where there is little space. Only use the MSC from the package to connect to Kuhnke's FIO module.

MSC model:	Weidmüller, OMNIMATE Signal – BL/SL series 3.50
Tool:	Screwdriver, 0.4 x 2.5 x 75 [mm] blade (DIN 5264-A)
Clamping range, rated connection	min. 0.14 mm ² ... max. 1.5 mm ²
Wire diameter AWG,	min. AWG 26 ... max. AWG 14
Outside diameter of insulation,	max. 2.9 mm
Wire diameter, single-wire,	min. H05(07) V-U 0.2 mm ² ... max. H05(07) V-U 1.5 mm ²
Wire diameter, fine wire,	min. H05(07) V-K 0.2 mm ² ... max. H05(07) V-K 1.5 mm ²
Wire diameter with connector sleeve to DIN 46 228/1,	min. 0.2 mm ² ... max. 1.5 mm ²
Wire diameter with connector sleeve with collar to DIN 46 228/4, Stripped end 10 mm	min. 0.2 mm ² ... max. 1 mm ²
Nominal current:	10 A (CSA) / 10 A (UL)

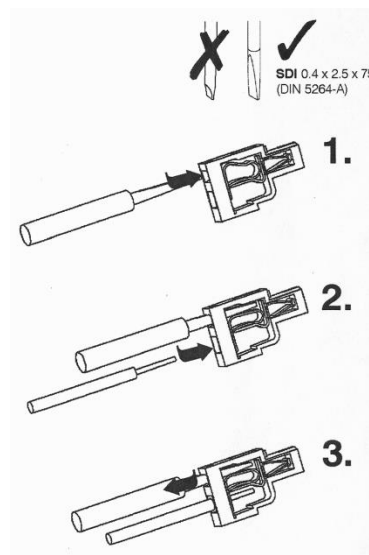

	WARNING
	<p>Potentially hazardous failure due to improper wiring <i>Short circuits between adjacent terminals may damage or destroy the unit and may provoke potentially hazardous failures.</i></p> <p>⇒ Preventive measures: Ensure proper wiring</p>

	NOTE
	<p>Destruction by wrong tool <i>Damage to Kuhnke's FIO Safety I/O module</i></p> <p>⇒ Use suitable tools for wiring the multiple socket connector only! ⇒ Tool: Screwdriver, 0.4 x 2.5 x 75 [mm] blade (DIN 5264-A)</p>

6.3 Configuration

	Attention
	<p>Check the safety function Potential faults due to maladjusted configuration</p> <ul style="list-style-type: none"> After initial installation and after replacing a module, check the safety function!

6.3.1 Address Setup

FIO Safety has a safe module address (FSoE slave address) which clearly identifies it in the safe communication network. The address is set manually by means of binary switches on the left side of the module.

Use the 2x 8 DIP switches to set the FSoE address. Addresses range between 1 and 65535.

	Information
	<p>After setting the FSoE address, disconnect the FIO Safety module once from the power supply to ensure that the address is accepted and a module test started automatically.</p>

	Information
	<p>There is no access to the DIP switches once several modules have been lined up. To set the FSoE slave address at the DIP switch, first remove the module from the row of modules.</p>

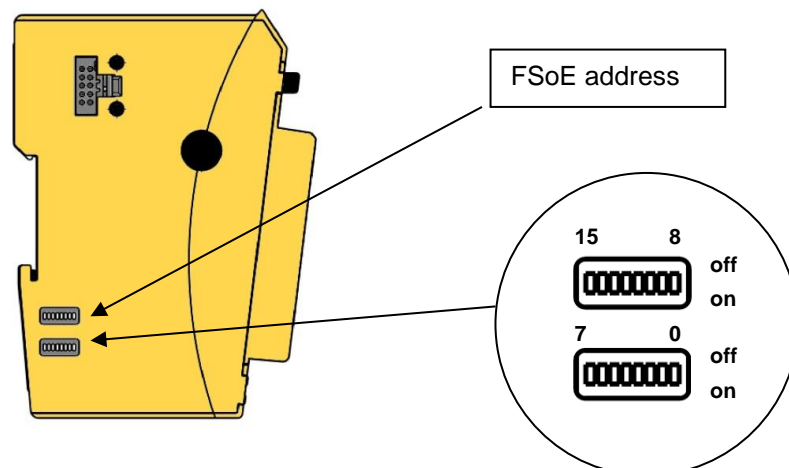

	NOTE
	<p>Destruction by wrong tool Damage to Kuhnke's FIO Safety I/O module</p> <ul style="list-style-type: none"> ⇒ Use suitable tools for setting the address only! Use a suitable object (e.g. the tip of a ball pen or a screwdriver) to set the DIP switches. Do not exert pressure on the switching elements!

NOTE

	<p>Inappropriate setup actions at the Kuhnke FIO Safety I/O module</p>
	<p><i>Machine failure and damage to the FIO Safety module</i></p> <ul style="list-style-type: none"> ⇒ Turn off the I/O supply before removing the FIO Safety module from the row of module for setup.

	<p>Attention</p>
	<p>Safety function not available</p> <p><i>Startup disallowed by wrongly set address</i></p> <ul style="list-style-type: none"> ⇒ Do a function test to verify that the address coding switches have been set correctly.

DIP switch																
Address	15	14	13	12	11	10	9	8	7	6	5	4	3	2	1	0
0	OFF	OFF	OFF	OFF	OFF	OFF	OFF	OFF	OFF	OFF	OFF	OFF	OFF	OFF	OFF	OFF
1	OFF	OFF	OFF	OFF	OFF	OFF	OFF	OFF	OFF	OFF	OFF	OFF	OFF	OFF	OFF	ON
2	OFF	OFF	OFF	OFF	OFF	OFF	OFF	OFF	OFF	OFF	OFF	OFF	OFF	OFF	ON	OFF
3	OFF	OFF	OFF	OFF	OFF	OFF	OFF	OFF	OFF	OFF	OFF	OFF	OFF	OFF	ON	ON
...
65535	ON	ON	ON	ON	ON	ON	ON	ON	ON	ON	ON	ON	ON	ON	ON	ON

	<p>Information</p>
	<p><i>The FSoE address you set may only occur once in the communication network. The master will find and notify the user of a FSoE address that occurs more than once or is not used.</i></p>

6.3.2 FSoE Parameters

	<p>CAUTION</p>
	<p>Improper operation of parameter setup</p> <p><i>Malfunction of Kuhnke's FIO Safety I/O module due to bad parameter setup</i></p> <ul style="list-style-type: none"> ⇒ Only persons qualified for dealing with safety matters are allowed to add, replace and put Safety I/O Modules into operation. ⇒ Before installing, servicing or putting Kuhnke FIO Safety into service, please also read the safety information in the preface of this document. ⇒ Before putting the unit into service, verify that all safety functions work as specified. ⇒ The module will not work if parameter settings are out of the specified valid range.

FSoE parameter																																																					
Parameter	Description / note	Unit																																																			
Range [Default]																																																					
FSoE address																																																					
1 ... 65535 [1]	FSoE slave address set at DIP switch	-																																																			
Connection ID																																																					
1 ... 65535 [1]	Unique ID of the connection to a FSoE slave	-																																																			
WatchdogTime																																																					
20 ... 65534 (0xFFFE) [100]	Watchdog time of FSoE frame	ms																																																			
Used Inputs																																																					
0 15 [15]	Enables the inputs used Selection from a drop-down list depends on the configurator	Dec																																																			
	<table border="1"> <thead> <tr> <th>Binary</th> <th>Decimal</th> <th>Active Inputs</th> </tr> </thead> <tbody> <tr><td>0 0 0 0</td><td>0</td><td>No inputs used</td></tr> <tr><td>0 0 0 1</td><td>1</td><td>Input 0</td></tr> <tr><td>0 0 1 0</td><td>2</td><td>Input 1</td></tr> <tr><td>0 0 1 1</td><td>3</td><td>Inputs 0,1</td></tr> <tr><td>0 1 0 0</td><td>4</td><td>Input 2</td></tr> <tr><td>0 1 0 1</td><td>5</td><td>Inputs 0,2</td></tr> <tr><td>0 1 1 0</td><td>6</td><td>Inputs 1,2</td></tr> <tr><td>0 1 1 1</td><td>7</td><td>Inputs 0,1,2</td></tr> <tr><td>1 0 0 0</td><td>8</td><td>Input 3</td></tr> <tr><td>1 0 0 1</td><td>9</td><td>Inputs 0,3</td></tr> <tr><td>1 0 1 0</td><td>10</td><td>Inputs 1,3</td></tr> <tr><td>1 0 1 1</td><td>11</td><td>Inputs 0,1,3</td></tr> <tr><td>1 1 0 0</td><td>12</td><td>Inputs 2,3</td></tr> <tr><td>1 1 0 1</td><td>13</td><td>Inputs 0,2,3</td></tr> <tr><td>1 1 1 0</td><td>14</td><td>Inputs 1,2,3</td></tr> <tr><td>1 1 1 1</td><td>15</td><td>Inputs 0,1,2,3</td></tr> </tbody> </table>	Binary	Decimal	Active Inputs	0 0 0 0	0	No inputs used	0 0 0 1	1	Input 0	0 0 1 0	2	Input 1	0 0 1 1	3	Inputs 0,1	0 1 0 0	4	Input 2	0 1 0 1	5	Inputs 0,2	0 1 1 0	6	Inputs 1,2	0 1 1 1	7	Inputs 0,1,2	1 0 0 0	8	Input 3	1 0 0 1	9	Inputs 0,3	1 0 1 0	10	Inputs 1,3	1 0 1 1	11	Inputs 0,1,3	1 1 0 0	12	Inputs 2,3	1 1 0 1	13	Inputs 0,2,3	1 1 1 0	14	Inputs 1,2,3	1 1 1 1	15	Inputs 0,1,2,3	
Binary	Decimal	Active Inputs																																																			
0 0 0 0	0	No inputs used																																																			
0 0 0 1	1	Input 0																																																			
0 0 1 0	2	Input 1																																																			
0 0 1 1	3	Inputs 0,1																																																			
0 1 0 0	4	Input 2																																																			
0 1 0 1	5	Inputs 0,2																																																			
0 1 1 0	6	Inputs 1,2																																																			
0 1 1 1	7	Inputs 0,1,2																																																			
1 0 0 0	8	Input 3																																																			
1 0 0 1	9	Inputs 0,3																																																			
1 0 1 0	10	Inputs 1,3																																																			
1 0 1 1	11	Inputs 0,1,3																																																			
1 1 0 0	12	Inputs 2,3																																																			
1 1 0 1	13	Inputs 0,2,3																																																			
1 1 1 0	14	Inputs 1,2,3																																																			
1 1 1 1	15	Inputs 0,1,2,3																																																			
External Inputs																																																					
Bits 0-3 0000 ₂ 1111 ₂ [0000 ₂]	Disables the generation of the module's test pulses if the sensors connected generate their own test pulses (OSSD) at the outputs or, optionally, for operation without test pulses (OSSD) and disables special functions rotary switch and pressure-sensitive mat.	Dec																																																			
	Test pulse outputs, bits 0-3 0 test pulse output is used 1 test pulse output is not used (external test pulses enabled)																																																				
Bits 4,5 00 ₂ ... 11 ₂ [00 ₂]	Mode selector, bits 4 and 5 00 disabled 01 2 channels (inputs 0 & 1) 10 3 channels (inputs 0 - 2) 11 4 channels (inputs 0 – 3)																																																				

Bits 6,7
00₂ ... 11₂
[00₂]

Pressure-sensitive mat / bumper, bits 6 & 7
00 disabled
01 inputs 0 & 1
10 inputs 2 & 3
11 inputs 0 & 1 and inputs 2 & 3

Bit					Decimal	Setting
7	5	4	3	2		
0	0	0	0	0	0	No function
0	0	0	0	0	1	Test pulse output of input 0 disabled
0	0	0	0	0	2	Test pulse output of input 1 disabled
0	0	0	0	1	4	Test pulse output of input 2 disabled
0	0	0	1	0	8	Test pulse output of input 3 disabled
0	0	0	1	1	15	All test pulse outputs of all inputs disabled
0	0	1	0	0	16	Mode selector, two channels (inputs 0 & 1)
0	1	0	0	0	32	Mode selector, three channels (inputs 0 - 2)
0	1	1	0	0	48	Mode selector, four channels (inputs 0 - 3)
0	0	0	0	0	64	Pressure-sensitive mat, inputs 0 & 1
1	0	0	0	0	128	Pressure-sensitive mat, inputs 2 & 3
1	0	0	0	0	192	Pressure-sensitive mat, inputs 0 & 1 and 2 & 3

Red cells:

- In mode selector or pressure-sensitive mat modes, disabling a test pulse output will provoke an error message
- Settings in red cells are therefore forbidden

Green cells:

- Pressure-sensitive mat mode available for inputs 0&1 or 2+3
- Mode selector mode available for inputs 0&1, 0-2 or 0-3

Blue cells:

- Test pulse outputs can be disabled

Example:

Assuming you wish to run a pressure-sensitive mat at inputs 0&1 of the Kuhnke FIO Safety SDI4 SDO2 module while disabling the test pulses of the other inputs (2&3). Set up as follows:

WatchdogTime	100
usedInputs	15
externalInputs	76
usedOutputs	3
extGroundOutputs	3

64 + 4 + 8 = 76

usedOutputs

Dec

00₂... 11₂
[00₂]

Enables the outputs you use (0 and / or 1)
Selection from a drop-down list depends on the configurator

00 outputs disabled
01 SO 0 enabled, SO 1 disabled
10 SO 0 disabled, SO 1 enabled
11 SO 0 enabled, SO 1 enabled

extGroundOutputs

Dec

00₂ ... 11₂
[00₂]

Enable if the actuator is not connected to module terminal SO X- but uses an external ground connection.
Selection from a drop-down list depends on the configurator

Test pulse duration input 0





µs

300 ... 1500
[500]

Test pulse length of input 0
Input filter of input 0

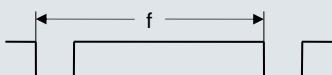
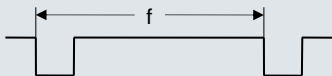
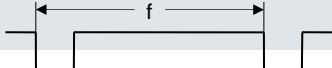

The digital test pulse output is interrupted for the set duration of every test pulse. The Kuhnke FIO Safety I/O module checks whether the digital inputs may turn Null and whether there are any short circuits to noise voltages on the signal line.
Adapt the test pulse duration to the peripherals you use.

Test pulse duration input 1		μs
300 ... 1500 [500]	Test pulse length of input 1 Input filter of input 1	
<p>The digital test pulse output is interrupted for the set duration of every test pulse. The Kuhnke FIO Safety I/O module checks whether the digital inputs may turn Null and whether there are any short circuits to noise voltages on the signal line.</p> <p>Adapt the test pulse duration to the peripherals you use.</p>		
Test pulse duration input 2		μs
300 ... 1500 [500]	Test pulse length of input 2 Input filter of input 2	
<p>The digital test pulse output is interrupted for the set duration of every test pulse. The Kuhnke FIO Safety I/O module checks whether the digital inputs may turn Null and whether there are any short circuits to noise voltages on the signal line.</p> <p>Adapt the test pulse duration to the peripherals you use.</p>		
Test pulse duration input 3		μs
300 ... 1500 [500]	Test pulse length of input 3 Input filter of input 3	
<p>The digital test pulse output is interrupted for the set duration of every test pulse. The Kuhnke FIO Safety I/O module checks whether the digital inputs may turn Null and whether there are any short circuits to noise voltages on the signal line.</p> <p>Adapt the test pulse duration to the peripherals you use.</p>		
Test pulse duration output 0		μs
500... 1500 [800]	Test pulse length of input 0	
<p>The digital power output is interrupted for the set duration of every test pulse. The Kuhnke FIO Safety I/O module checks whether the power outputs may be turned off and whether there are any short circuits to noise voltages on the output line. Adapt the test pulse duration to the load applied.</p>		
Test pulse duration output 1		μs
500... 1500 [800]	Test pulse length of input 1	
<p>The digital power output is interrupted for the set duration of every test pulse. The Kuhnke FIO Safety I/O module checks whether the power outputs may be turned off and whether there are any short circuits to noise voltages on the output line. Adapt the test pulse duration to the load applied.</p>		
Test frequency input 0		Hz
0 ... 25 [1]	Test pulse frequency of input 0 "0" = no test pulse	
Test frequency input 1		Hz
0 ... 25 [1]	Test pulse frequency of input 1 "0" = no test pulse	
Test frequency input 2		Hz
0 ... 25 [1]	Test pulse frequency of input 2 "0" = no test pulse	

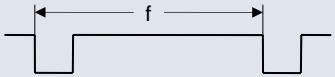
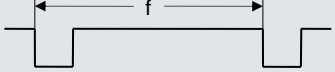
Test frequency input 3		Hz
0 ... 25 [1]	Test pulse frequency of input 3 "0" = no test pulse	
Test frequency output 0		min-1
0 ... 25 [1]	Test pulse frequency of output 0 "0" = no test pulse ¹	
Test frequency output 1		min-1
0 ... 25 [1]	Test pulse frequency of output 1 "0" = no test pulse ²	

6.3.3 Input Parameters

 CAUTION
<p>Consideration of the parameterization</p> <p>For single-channel applications (inputs and outputs), the test pulse frequency should be adapted to the application. It must be ensured that in applications in which a frequent change of state occurs, the test pulse frequency is selected at least 100 times greater than the state change time of the application.</p> <p>⇒ See FSoE Parameters 6.3.2</p>

Parameters "Used Inputs" and "External Inputs"

Use these parameters to enable the inputs of the Kuhnke FIO Safety I/O module and to select the input function. Use parameter "External Inputs" to disable the module's test pulse outputs that deliver test pulses to each of the inputs. Use this setting for sensors generating their own test pulses (some light barriers, for example).

 WARNING
<p>Non-detection of a corrupt external wiring when test pulse outputs are disabled</p> <p>Unsafe machine state, safety hazard</p> <ul style="list-style-type: none"> ⇒ Always use the correct and enabled test pulse output to supply power to contact-type sensors. ⇒ Note: Consider protecting the cables and/or laying them separately to ensure a sufficient degree of safety.

In "Mode Selector" mode, you can connect 2, 3 or 4 inputs to test pulse output SI0 TP and to a mode selector. Disable the test pulse outputs you do not need. Refer to manual section →7.4 Mode Selector for a wiring example. Inputs you do not use and the associated test pulse outputs can be used for other functions. "Pressure-sensitive Mat/Bumper" mode uses pairs of 2 inputs and the associated test pulse outputs. Parameter "External Input" allows you to separately choose the function of inputs 0 & 1 and 2 & 3. Inputs you do not use and the associated test pulse outputs can be used for other functions. Refer to manual section →7.5 Safety Mats, Connecting Blocks and Bumpers for a wiring example.

¹ The test pulses of both outputs must be deactivated so that no test pulses are generated.
Please also observe the notes in the chapter Output Parameters 6.3.4

² See footnote 1

Parameter "Test pulse duration input"

If used together with the module's test pulse outputs, test pulses cyclically check the input circuit connected to the Kuhnke FIO Safety I/O module for faults such as short circuits or internal defects. Parameter "Test pulse duration output" sets the time of a test pulse allocated to a digital test pulse output. It also sets the filtering time of the digital inputs. You may have to modify the test pulse duration if the signals are affected by capacitive properties of the input circuit, for example.

Parameter "Test frequency input"

If used together with the module's test pulse outputs, test pulses cyclically check the input circuit connected to the Kuhnke FIO Safety I/O module for faults such as short circuits or internal defects. Parameter "Test pulse duration input" sets the switching frequency and, thus, the frequency of test pulses allocated to a digital test pulse output.

	WARNING
	<p><i>Non-detection of a corrupt external wiring when test pulse outputs are disabled</i> <i>Unsafe machine state, safety hazard</i></p> <ul style="list-style-type: none"> ⇒ Always use the correct and enabled test pulse output to supply power to contact-type sensors. ⇒ Note: Consider protecting the cables and/or laying them separately to ensure a sufficient degree of safety.

6.3.4 Output Parameters

	CAUTION
	<p><i>Consideration of the parameterization</i> <i>For single-channel applications (inputs and outputs), the test pulse frequency should be adapted to the application. It must be ensured that in applications in which a frequent change of state occurs, the test pulse frequency is selected at least 100 times greater than the state change time of the application.</i></p> <ul style="list-style-type: none"> ⇒ See FSoE Parameters 6.3.2

Parameter "extGroundOutputs"

Enable if the sensor is not connected to module terminal SO X- but uses an external ground connection. Pick from a drop-down list provided by the configurator software. Linking the sensor to an external ground connection instead of terminal SO X- disallows you to control an external 24 VDC power supply.

Also set this parameter if output SO X+ supplies an electronic load such as a digital input of an I/O module.

Parameter "Used Outputs"

Enables the outputs you use (SO 0 and / or SO 1)

Pick from a drop-down list

Parameter "Test pulse duration output"

Test pulses cyclically check the digital outputs of the Kuhnke FIO Safety I/O module for faults such as short circuits or internal defects. Parameter "Test pulse duration output" sets the time of a test pulse allocated to a digital output. If you connect a capacitive load to the digital power output, you may have to modify the test pulse duration.

	NOTE
	<p>Test pulses to the outputs</p> <p><i>Match the connected loads and the test pulse duration setting such that the test pulses are prevented from switching the loads.</i></p>

Parameter "Test frequency output"

Test pulses cyclically test the digital outputs of the Kuhnke FIO Safety I/O module. Parameter "Test frequency output" sets the switching frequency and, thus, the frequency of test pulses allocated to a digital output. Adapt this parameter to real-life conditions particularly when using inductive or capacitive loads.

	CAUTION
	<p>Shut-off of test pulses to the output</p> <p><i>Owing to the construction of the outputs, shutting off the test pulses to an output channel will not stop test pulses from being generated at that output if test pulse are still set for the other output channel. Frequency and length of these test pulses are determined by the other output. Verify that these test pulses cannot switch the actuators connected.</i></p> <p>⇒ To stop the generation of test pulses, you must disable the test pulses to both outputs.</p>

	WARNING
	<p>Non-detection of incorrect external wiring while test pulses are disabled</p> <p><i>Unsafe machine state, safety hazard</i></p> <ul style="list-style-type: none"> ⇒ Use the output test pulses to detect cross-faults at the outputs and other faults. ⇒ Note: Consider protecting the cables and/or laying them separately to ensure a sufficient degree of safety. ⇒ Switching off the test pulses is not recommended, it can reduce the safety of the application.

	CAUTION
	<p>Minimum length of test pulses</p> <p><i>Owing to the construction of the outputs, different test pulse length settings of the two output channels will generate test pulses of the minimum length set for both outputs of both channels.</i></p> <ul style="list-style-type: none"> ⇒ Verify that both outputs comply with this minimum value to ensure that all test pulses are of a minimum length. Verify that this minimum test pulse length cannot switch the actuators connected.

	WARNING
	<p>Reduced diagnosis with deactivated test pulses at the outputs</p> <p><i>Switching off the test pulses is not recommended, it can reduce the safety of the application. With the test pulses switched off at the outputs, it is necessary to maintain the diagnosis of the outputs by:</i></p> <ul style="list-style-type: none"> ⇒ The outputs are switched once a year and the switching is done functionally (by the application) or by completely turning the device off.

6.4 Putting into Service



Note, information

Usage note

Kuhnke's FIO Safety I/O module may be used ETG-compliant configurations with conforming products. Such products include slave services, master and development systems, and functional safety products. Check the products for the "EtherCAT Conformance tested" to see if they have passed an official test for conformity. Certified products are listed in the EtherCAT Product Guide published by the EtherCAT Technology Group.

Topology of CODESYS devices

Like in all other CODESYS projects, the project environment of safety projects must identically reflect the hardware topology. You can either set up the topology manually or, provided that all device descriptions have been installed, start a search for devices in CODESYS. Right-click on the EtherCAT master and pick "Geräte suchen..." (Find devices) from the context menu. In the next dialog, you just need to confirm to "Alle Geräte ins Projekt kopieren" (Copy all devices to project).

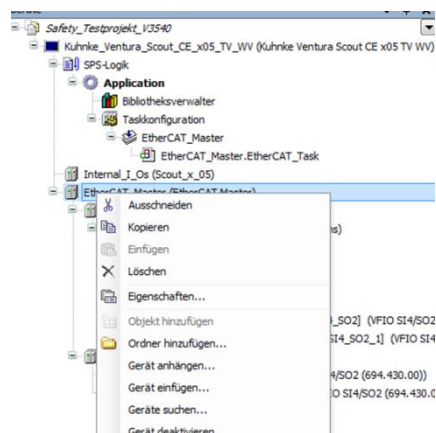

CODESYS configuration example:

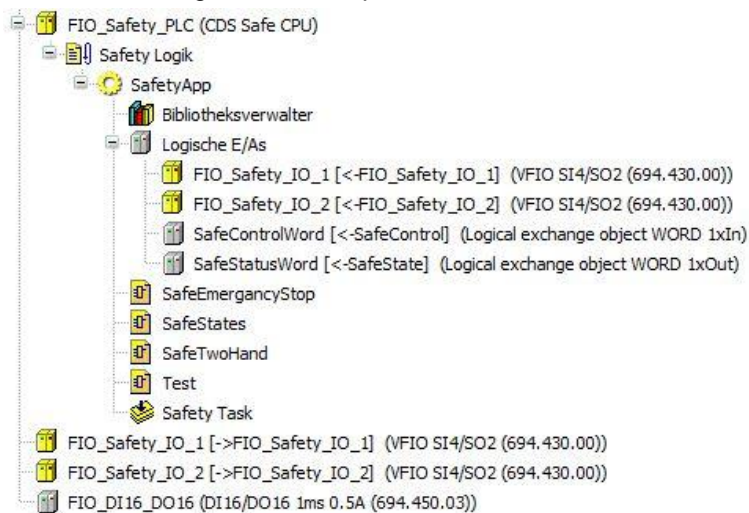

Refer to the manual of your PLC to know how to set up a CODESYS project.

6.5 Diagnosis

6.5.1 Self-test

When system voltage is supplied to the Kuhnke Safety module, it initially runs a complete system test. Only if this system test is passed will the module be able to operate and first of all change to its "fail-safe" state.

This is indicated by LED "Safe Status" lighting up red.

The FIO Safety I/O module will retain the fail-safe state until all internal tests have been passed, valid data has been received from the control unit, and faults are not detected in any of the external hardware, sensors, actuators and their wiring.

A safe functional state is indicated by LED "Safe Status" lighting up green.

The module will retain its fail-safe state if it fails to qualify for the safe state, e.g. because of errors in the application's module setup. To find the cause of the problem, check the error code in the service block → 6.5.6 Table of Faults.

In service, the system test is repeated cyclically as a background process.

To repeat the initial system test, just turn the power supply off and back on again.

6.5.2 Kuhnke FIO Safety I/O Module Faults

The cyclic system test will duly detect all faults in the module within the minimum safe failover time specified in section Technical Data in conformity with the requirements of the standards listed in the certificate. The module will change to its fail-safe state.

This is indicated by LED "Safe Status" lighting up red.

	DANGER
	<p><i>Use of devices in a fail-safe state</i></p> <p><i>The following faults may provoke a hazard</i></p> <p>⇒ Whenever a fault occurs, initiate all the required repairs or replacements.</p>

6.5.3 Wrong Wiring

Wiring faults such as

- a cross-fault between the inputs,
- external power supplied to the inputs,
- wrong TP allocation to a specific input,
- external power supplied to the outputs, or
- a short at the outputs

will change the Kuhnke FIO Safety I/O module to its safe state. The red Diagnosis LED of the affected channel lights up.

Error messages may also be provoked by badly adjusted loads. Please refer to sections 4.5.4 Safe Digital Outputs and 6.2.8 Actuator Connection.

6.5.4 Temperature Faults

	CAUTION
	<p><i>Do not operate the FIO Safety I/O module out of the specified range</i></p> <p><i>Faults by component overload caused by excessive temperature</i></p> <p>⇒ Operate the module under the ambient conditions listed in section Technical Data only while observing the derating of the outputs.</p>

The module is designed for ambient temperatures between 0 °C and max. 55 °C and for being installed in a control cabinet. The FIO Safety I/O module features an extra internal temperature sensor. Excess temperature will change the module to its safe state. You cannot start the module at temperatures below 0 °C.

6.5.5 Wrong Supply Voltage

The supply voltage is rated at 24 VDC. It is monitored. In case of overvoltage (> +20%) and low voltage (< -15%) alike, the module changes to its safe state.

6.5.6 Table of Faults

Depending on their type, faults detected are indicated by the diagnosis LEDs of the Kuhnke FIO Safety I/O module and made available as a diagnostic message in error register object 1001_h. Diagnostic messages help you identify the fault and to take the required corrective actions.

The tables below list and describe the faults, their causes, effects and corrective actions.

Whenever a fault occurs, you should first of all remove its cause and acknowledge the fault in the error register according to instructions.

Table of faults		
Fault	Possible Cause	Corrective Action
Module fails to start, inputs are not read.	Wrong FSoE address set at the binary switch	<ul style="list-style-type: none"> • Check address setting at the module • Check address selected in the safety PLC • Check module for mechanical damage and replace as necessary
Inputs enabled although outputs are in safe state	FSoE slave address changed in service System power supply interrupted System power supply too low	<ul style="list-style-type: none"> • Check error code in the service block • Do not change the address coding switch in service • Check module for mechanical damage and replace as necessary • Check supply voltage
Module is in safe state, diagnosis LEDs of the inputs light up red	Wrong wiring, e.g. test pulse signals swapped Cross-fault between the inputs External power supplied to the outputs	<ul style="list-style-type: none"> • Check error code in the service block • Check module wiring
Module is in safe state, one diagnosis LED at the output lights up red	Overload on an output Cross-fault at an output External power supplied to an output	<ul style="list-style-type: none"> • Check error code in the service block • Check module wiring • Check the output current of the output
Module is in safe state, LED "Safe Status" lights up red	EtherCAT connection interrupted Internal module fault	<ul style="list-style-type: none"> • Check wiring of the EtherCAT fieldbus cables • Check that FIO modules interconnect properly
Module is in safe state, LED "Safe Status" lights up red	I/O power is low	<ul style="list-style-type: none"> • Check I/O power • Check wiring

6.5.7 Error Codes

Error codes (object dictionary 0x2007 or 0x2017 - Err.code)		
Error Code (hex)	Cause	Comment
Effect		Corrective Action
0x0001	Internal software error	Internal module monitoring has detected an error. Inputs and outputs change to the safe state, FSoE communication stops.
Module in safe state		<ul style="list-style-type: none"> Module RESET by turning the system power off and back on again – self-test repeats. Replace module if error prevails
0x0002	Internal hardware fault	Internal module monitoring has detected a hardware fault. Inputs and outputs change to the safe state, FSoE communication stops.
Module in safe state		<ul style="list-style-type: none"> Module RESET by turning the system power off and back on again – self-test repeats. Replace module if error prevails
0x0402	Low voltage	Voltage supplied to the module is below the admissible range. Inputs and outputs change to the safe state, FSoE communication stops.
Module in safe state		<ul style="list-style-type: none"> Check actual system power supplied Check length and stress on the feed line
E.g. 0x0201	Parameter error	Module fails to change to its functional state.
Module in safe state		<ul style="list-style-type: none"> Check module parameter setup Use parameter settings in the admissible range only
E.g. 0x0291	Cross-fault at or external power supplied to input	Cross-fault to another input or test pulse output or external power supplied; red diagnosis LED of affected channel lights up. Inputs and outputs turn "0" at the module and in the process map.
Module in safe state		<ul style="list-style-type: none"> Check sensor Check test pulse outputs Check connector and wiring
E.g. 0x0291	Short circuit or overload	Short circuit in the output wiring or wrong output load, red diagnosis LED of affected channel lights up
Module in safe state		<ul style="list-style-type: none"> Check actuator Check connector and wiring Check free wheel wiring at contactor
E.g. 0x0280	Cross-fault at or external power supplied to output	Cross-fault to another output or another signal; red diagnosis LED of affected channel lights up
Module in safe state		<ul style="list-style-type: none"> Check actuator Check connector and wiring

**Information**

For a detailed description of the entry in object 2007_h or 2017_h "Err.code", refer to the table in section 8.1.10

6.5.8 EtherCAT Link Lost

All modules change to their safe state when the EtherCAT link is lost or interrupted. Once the fault has been removed, an Error Acknowledge is enough to restart the EtherCAT bus.

6.5.9 Wrong FSoE Address

A wrong FSoE address causes all modules to retain their safe state. The fault is detected by the master and cannot be acknowledged.



Once all FSoE addresses are correct, the safety modules will restart normal operation after one power cycle.

6.5.10 Wrong Configuration of the Kuhnke FIO Safety SDI4/SDO2 Module

By design, safety control units prevent configuration errors from provoking dangerous states. Therefore, after downloading a safety project with a bad configuration, all safety module are in a safe state. The master shows the incorrect configuration.

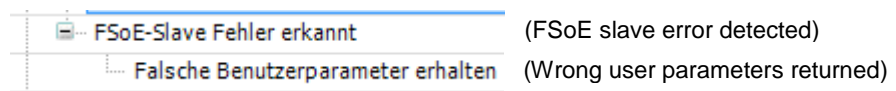

To restart the safety modules, first remove the incorrect configuration, then download the project again and finally Acknowledge the error³.

³ Provided that there are no faults

6.6 Reset / Acknowledge Error

The error class decides whether and how an error can be acknowledged, see section → 8.1.13 .Err.class 200Ah

Error Class	Explanation	Acknowledged / Reset by
0	No error	Not required
1	Serious or synchronization error	PowerCycle
2	Internal communication error	PowerCycle
3	I/O error	Error Acknowledge
4	Error in ErrorHandler or at the outputs	PowerCycle
5	Fatal error	Non-acknowledgeable

PowerCycle:

After removing the cause of the error, you can reset the Kuhnke FIO Safety SDI4/SDO2 module by a power cycle (PowerCycle -> turn off and back on) provided that the automatic self-test is passed.

Error Acknowledge:

Input or output errors can be reset by the safety PLC.

	WARNING
	<p><i>Reset / acknowledge may cause a dangerous state</i></p> <p><i>Apart from the exceptions specified, acknowledging an error will immediately restore the safe output to its normal state of operation.</i></p> <ul style="list-style-type: none"> ⇒ Before acknowledging an error, verify that its cause has been removed professionally. ⇒ Before acknowledging an error, verify that acknowledging it will not cause a dangerous machine state. ⇒ At the machine or system planning stage, make sure that acknowledging an error must not be possible unless you have full view of the danger zone.

6.7 Maintenance / Servicing

6.7.1 General

Only qualified persons are allowed to work on FIO Safety.

	CAUTION
	<p><i>Unsafe and undefined machine state</i></p> <p><i>Destruction or malfunction</i></p> <ul style="list-style-type: none"> ⇒ Do not plug, mount, unplug or touch the connectors during operation! ⇒ Turn off all power sources before working on the modules. This also applies to any peripherals such as encoders or programming devices with external power source, etc. ⇒ Check that none of the ventilation slots is covered.

6.7.2 Servicing

FIO Safety requires neither servicing for the specified service life nor any action if it is kept and operated at the admissible ambient conditions specified in section Technical Data.

6.7.3 Preventive Maintenance

Prevent inadmissible contamination while operating and storing FIO Safety. Do not use or continue to use the Kuhnke FIO Safety I/O module in case it has been exposed to inadmissible contamination.

	CAUTION
	<p><i>Unsafe and undefined machine state</i></p> <p><i>Risk of injury</i></p> <p>⇒ You are not allowed to operate an inadmissibly contaminated module. Neither is cleaning the unit allowed.</p>

6.8 Replacing a Kuhnke FIO Safety I/O Module

When you replace a Kuhnke FIO Safety I/O module, its configuration is retained and transferred to the new module when you restart the system. The programming environment will tell you if the new module is incompatible. You must carry out appropriate tests to verify whether there are any other failure modes such as using the wrong terminals or making wiring mistakes.

The text below describes how to replace a Kuhnke FIO Safety I/O module with a Kuhnke FIO Safety I/O module of the same type.

	CAUTION
	<p><i>Unsafe and undefined machine state</i></p> <p><i>Risk of injury</i></p> <p>⇒ Turn off the power supply of the control unit and the FIO modules before replacing a Kuhnke FIO Safety I/O module.</p> <p>⇒ After you have replaced any Kuhnke FIO Safety I/O modules, separately test the safety function before you restart the machine or system.</p> <p>⇒ Design your wiring tests such that you will reliably discover the use of a wrong terminal.</p>

	NOTE
	<p><i>You must set up your entire project again if you replace a Kuhnke FIO Safety I/O module with a module of another type. If so, refer to the user guide of the new module.</i></p>

Procedure

- Verify that the new module meets the following requirements:
 - Same type of device
 - Same or higher version, see section → 5.1 Labelling and Identification
- Enable the safe system or machine state.
- Turn off the power supply of the control unit and the FIO modules.
- To remove the old module (see sections → 6.1.4 To Disconnect Two Modules and 6.1.5 To Take Down a Single Module):
 - Dissolve the line of FIO modules by pressing the unlock button of the module to be separated from the module to its left and sliding both modules about 1 cm apart.
 - Push the module up and against the metal spring located on the underside of the rail guide.
 - Tip the module away from the rail as shown in the illustration.
 - Pull the module down and out of the mounting rail.

- Locate the FSoE address at the address coding switch of the module you are replacing and transfer that address to the new module → 6.3.1 Address Setup
- Install the new module at the same place within the line of FIO modules as one you just removed (→ 6.1.2 To Snap on a Single Module).
- Plug the inline connectors to the correct ports.

Restart

- Verify that the machine or system is in a safe state and that there is nothing and nobody in the danger zone.
- Turn the supply voltage back on.
- Start the new safety module as if you initially operate a module → 6.4 Putting into Service
 - The configuration of the old module has been retained and will be transferred to the new module when you restart the system.
- Check all safety functions after replacing a module.

6.9 Durability

Kuhnke FIO Safety I/O modules have a design life of max. 20 years after the date of manufacture (5.1.2 Serial Number) by Kendrion Kuhnke Automation GmbH. Take the module out of service at the end of its useful life → 6.9.3 Taking out of Service.

6.9.1 Repairs / Customer Service

You are not allowed to open or try to repair a FIO Safety I/O module.
Doing so will void the warranty.

	Note, information
	<p><i>In case of a potentially hazardous failure</i> <i>In case a module failure is potentially hazardous, return the module to the manufacturer where the fault will be identified.</i></p> <p>⇒ The manufacturer's address is printed on the Kuhnke FIO Safety SDI/SDO2 module and in manual section → 9.1.1 Malente Headquarters</p>

6.9.2 Warranty

The statutory period and conditions of warranty apply. Warranty expires if unauthorised attempts are made to repair the unit / product or any other intervention is performed, see section 2.1.4 Warranty.

6.9.3 Taking out of Service

The manufacturer of the machine or system specifies the procedure of taking the product out of service. The process must fully comply with the specified procedure.

Make sure that the modules of the Kuhnke FIO Safety system you are taking out of service are provided for further use as intended. Refer to section Technical Data for detailed transport and storage requirements.

6.9.4 Disposal

Dispose of the Kuhnke FIO Safety system in conformity with the applicable environmental regulations and make sure that it is not returned into circulation.

Treat the packaging as recyclable paper and cardboard.

7 Connection Examples

This section describes examples of applications that make use of the Kuhnke FIO Safety I/O module functions to provide a safety function. It also describes the resulting safety ratings.

	CAUTION
	<p><i>Using the examples described in this section is not enough to obtain the safety function needed to reduce the risk as established in the risk assessment (SIL/Cat./PL).</i></p> <p><i>Personal injury and damage to property</i></p> <ul style="list-style-type: none"> ⇒ Choose suitable and approved sensors (e.g. to EN 60947-5-1 / -5.) and make sure that your switching devices have the appropriate B10d value. ⇒ You may have to take further actions to obtain the safety function when using the system together with safe devices, sensor and actuators (e.g. reading the relay contact signals). Refer to the user guide of you safe devices for further details. ⇒ Configure your Kuhnke FIO Safety I/O module with reference to the actual environment.

The safety ratings listed for the examples below solely apply to the part of the safety function covered by the safe I/O module. Please note that the safety ratings below only apply if the test pulses are enabled.

	WARNING
	<p><i>Non-detection of incorrect external wiring while test pulses are disabled</i></p> <p><i>Unsafe machine state, safety hazard</i></p> <ul style="list-style-type: none"> ⇒ Always use the corresponding activated test pulse output for the supply of contact-type sensors. ⇒ Use the output test pulses to detect cross-faults at the outputs and other faults. ⇒ Note: Consider protecting the cables and/or laying them separately to ensure a sufficient degree of safety. ⇒ Switching off the test pulses is not recommended, it can reduce the safety of the application.

	WARNING
	<p><i>Reduced diagnosis with deactivated test pulses at the outputs</i></p> <p><i>Switching off the test pulses is not recommended, it can reduce the safety of the application. With the test pulses switched off at the outputs, it is necessary to maintain the diagnosis of the outputs by:</i></p> <ul style="list-style-type: none"> ⇒ The outputs are switched once a year and the switching is done functionally (by the application) or by completely turning the device off.

7.1 Safety Function with Single-channel Input

	<p>CAUTION</p>
<p>Consideration of the parameterization</p> <p><i>For single-channel applications (inputs and outputs), the test pulse frequency should be adapted to the application. It must be ensured that in applications in which a frequent change of state occurs, the test pulse frequency is selected at least 100 times greater than the state change time of the application.</i></p> <p>⇒ See FSoE Parameters 6.3.2</p>	

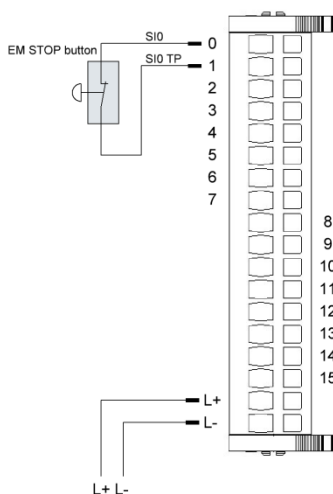

You may connect contact-type sensors such as emergency stop buttons straight to a safe digital input.

By default, a test pulse output is dedicated to every input channel. This test pulse output supplies a specific signal you may use to detect wiring problems such as a short circuit to 24 VDC, GND or other signal channels. The state of connected switches is indicated by LEDs allocated to the channels (see section → 5.4 Indicators and Controls).

Whenever an emergency stop button is pressed, the safety PLC will generate a stop signal. Resetting the emergency stop device must not be enough to initiate a restart signal.

Safety ratings of single-channel sensors

The safety ratings listed in the table below reflect the maximum values a single-channel safety function may achieve when using a single input of the safe I/O module. They solely apply to the part of the safety function covered by the safe I/O module. All components involved in the safety function must be taken into account in order to assess whether the desired safety ratings are achieved. The quality of the safe sensor is of crucial importance with particular regard to the safety function of analysing a single-channel sensor. Use approved sensors only (e.g. to EN 60947-5-1 / -5.) and take account of your switching device's B10d value. The safety assessment of the safety function must also consider the safety ratings of the safe PLC used in the application.

Safety ratings when applying the module's test pulses to single-channel contact-type sensors	
Highest safety integrity level to EN 62061:2010	SIL2
Highest safety integrity level to IEC 61508:2010	SIL2
Category and highest performance level to EN ISO 13849-1:2015	Cat. 2/PL d
Hardware fault tolerance (HFT) of single-channel application (IEC 61508:2010/EN)	0 (a fault of the application may cause the safeguard to fail)

7.2 Safety Function with Two-channel Input

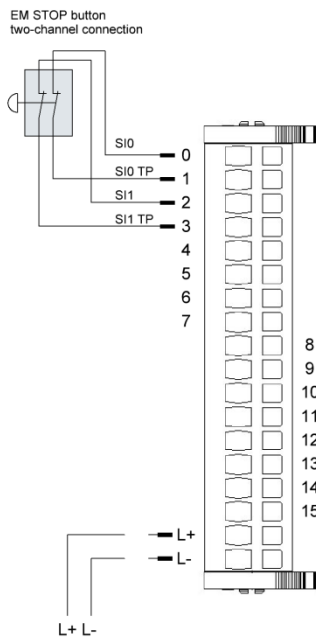

For applications requiring single-fault safety such as EMERGENCY OFF, EMERGENCY STOP, you may connect two digital inputs to two switching devices of safe sensors and further to the safety module.

A software module of the safety PLC provides the required analysis of the switching contacts.

"**FB_ESTOP**" is a safety-related component intended to monitor an EMERGENCY STOP button. FB_ESTOP can be used for both the emergency switch off function (stop category 0) or – with the assistance of additional peripherals - the EMERGENCY STOP function (stop categories 1 or 2).

FB_ESTOP can be used to monitor single and two-channel EMERGENCY STOP switches. The component's discrepancy time monitoring is enabled for two-channel applications.

Discrepancy time monitoring: The discrepancy time defines as the maximum length of time both inputs may be in different states without the component interpreting this as a fault. Discrepancy time monitoring starts whenever the state of one input changes. The components will detect a fault if, at the end of the discrepancy time, both inputs are in different states.

Safety ratings of two-channel sensors

The safety ratings listed in the table below reflect the maximum values a two-channel safety function may achieve when using two inputs of the safe I/O module. They solely apply to the part of the safety function covered by the safe I/O module. All components involved in the safety function must be taken into account in order to assess whether the desired safety ratings are achieved. The quality of the safe sensor is of crucial importance with particular regard to the safety function of analysing a two-channel sensor. Use approved sensors only (e.g. to EN 60947-5-1 / -5.) and take account of your switching device's B10d value. The safety assessment of the safety function must also consider the safety ratings of the safe PLC used in the application.

Safety ratings when applying the module's test pulses to two-channel contact-type sensors	
Highest safety integrity level to EN 62061:2010	SIL3
Highest safety integrity level to IEC 61508:2010	SIL3
Category and highest performance level to EN ISO 13849-1:2015	Cat. 3/PL e
Hardware fault tolerance (HFT) of two-channel application (IEC 61508:2010/EN)	1 (a fault of the application need not cause the safeguard to fail)

7.3 Two-hand Actuation

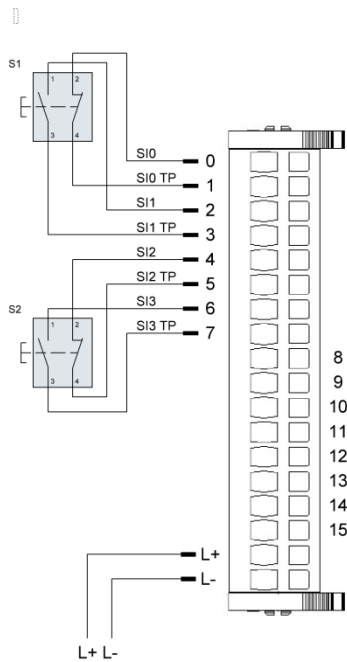

Two contact-type sensors can be connected to four safe digital inputs. A software module of the safety PLC provides the analysis required for two-hand operation.

Two-hand circuit type 2

Software component " **FB_TWOHAND_TYP2**" supports function "two-hand circuit type 2" in conformity with European Standard EN 574:2008. If S1 and S2 are set to TRUE in the correct order, bTwoHandOut will also become TRUE. The component also checks that both buttons have been released before setting output bTwoHandOut to TRUE again.

Two-hand circuit type 3

Software component " **FB_TWOHAND_TYP3**" supports function "two-hand circuit type 3" in conformity with the European Standard. If S1 and S2 are set to TRUE in the correct order and within 500 ms, bTwoHandOut will also become TRUE. The component also checks that both buttons have been released before setting output S_TwoHandOut to TRUE again.

Note: Category 3 does not support more than one two-hand circuit of type III B.

Safety ratings of two-channel sensors

The safety ratings listed in the table below reflect the maximum values a two-channel safety function may achieve when using four inputs of the safe I/O module. They solely apply to the part of the safety function covered by the safe I/O module. All components involved in the safety function must be taken into account in order to assess whether the desired safety ratings are achieved. The quality of the safe sensor is of crucial importance with particular regard to the safety function of analysing a two-hand operation. Use approved sensors only (e.g. to EN 60947-5-1 / -5.) and take account of your switching device's B10d value. The safety assessment of the safety function must also consider the safety ratings of the safe PLC used in the application.

Safety ratings for function two-hand operation	
Highest safety integrity level to EN 62061:2010	SIL3
Highest safety integrity level to IEC 61508:2010	SIL3
Category and highest performance level to EN ISO 13849-1:2015	Cat. 3/PL e
Hardware fault tolerance (HFT) of two-channel application (IEC 61508:2010/EN)	1 (a fault of the application need not cause the safeguard to fail)

	CAUTION
	<p>Safety hazard due to wrong handling of the two-hand circuit</p> <ul style="list-style-type: none"> ⇒ Comply with EN 574:2008 and other requirements and standards published on two-hand circuits. ⇒ Switches/sensors, wiring and application must comply with EN 574:2008.

7.4 Mode Selector, Rotary Table

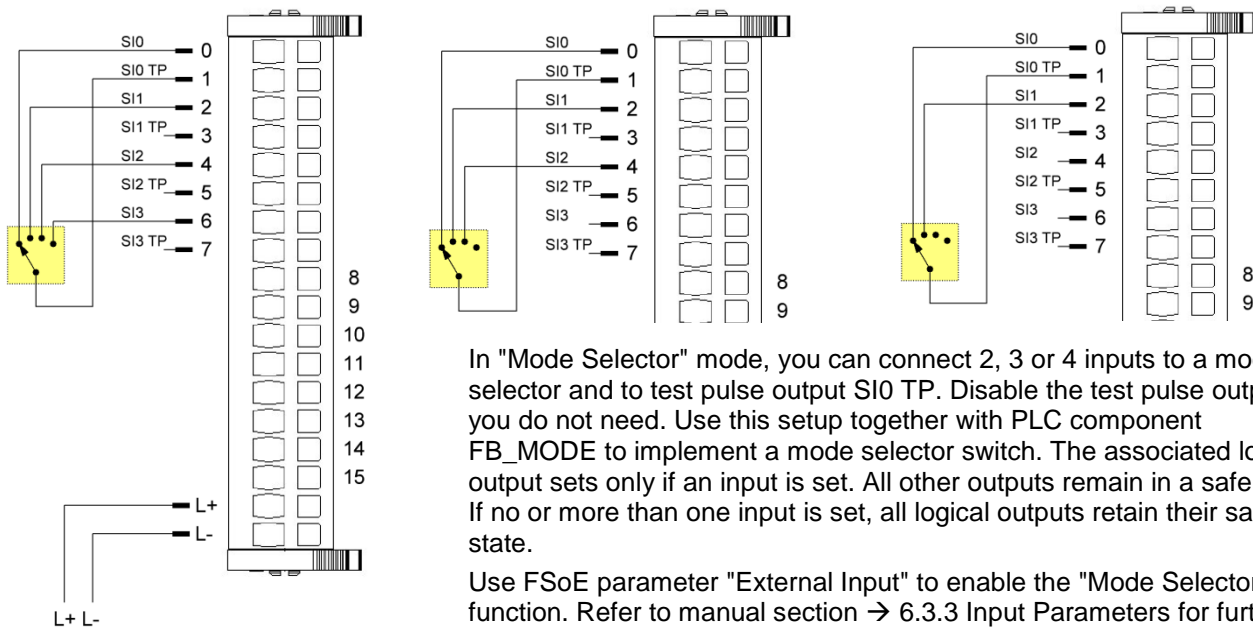

Safety ratings of mode selector applications in conjunction with switches/sensors approved to EN 13849-2, Table D.3

Highest safety integrity level to EN 62061:2010	SIL2
Highest safety integrity level to IEC 61508:2010	SIL2
Category and highest performance level to EN ISO 13849-1:2015	Cat. 1/PL c
Hardware fault tolerance (HFT) of two-channel application (IEC 61508:2010/EN)	0 (a fault of the application may cause the safeguard to fail)

Safety ratings of mode selector applications in conjunction with certified switches/sensors of the appropriate safety classification

Highest safety integrity level to EN 62061:2010	SIL3
Highest safety integrity level to IEC 61508:2010	SIL3
Category and highest performance level to EN ISO 13849-1:2015	Cat. 3/PL e
Hardware fault tolerance (HFT) of two-channel application (IEC 61508:2010/EN)	1 (a fault of the application need not cause the safeguard to fail)



NOTE

Test pulse output

In mode selector mode, test pulse output TP0 can be set to "0". However, this will not affect the test pulse as such since, in mode selector mode, the test pulse always runs at maximum frequency.

	NOTE
	<p>Time discrepancy in mode selector/rotary table mode <i>A set time discrepancy of 100 ms has been implemented for signals missing at the inputs when changing to mode selector mode.</i></p>

7.5 Safety Mats, Connecting Blocks and Bumpers

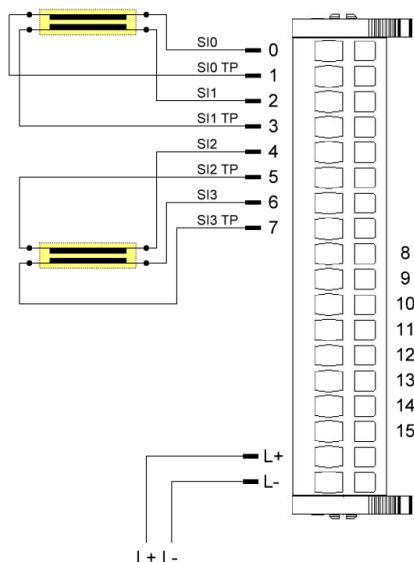

Safety mats protect operators in danger zones. Connecting blocks and bumpers are normally used as safeguards along closing edges or against potentially hazardous moving objects. They share the same tripping method. Two parallel areas of contact are kept at a certain distance and do not make contact until the device is actuated. An electric current going through the areas of contact ensures that they are ready for use. The picture illustrates that one area of contact is allocated to one channel and the other area to another channel. Mechanical load on the area of contact makes the inputs connect. This is not interpreted as a short circuit but as actuation. Use FSoE parameter "External Input" to enable the "Bumper" function. Refer to manual section → 6.3.3 Input Parameters for further details. This mode only supports pressure-sensitive mats working according to the open circuit principle, i.e. the test pulses required to maintain a safe function are supplied by the safe I/O module.

The function uses either inputs SI0 and SI1 and/or inputs SI2 and SI3. The pressure-sensitive mat function achieves a response time of **50 ms** between a change in mat state and providing the information on the EtherCAT bus.

Safety characteristics of dual-channel sensors

The safety characteristics specified in the following table are the maximum values that can be achieved with a two-channel safety function using two inputs of the safe IO module. The values apply exclusively to the part of the safety function that is covered by the safe IO module. To achieve the desired safety characteristics, all components involved in the safety function must be taken into account. For the safety function of a safety mat application, the quality of the safe sensor is particularly crucial for this. Only approved sensors should be used (eg according to EN 60947-5-1 / -5.) And the B10d value of the switching element used should be taken into account. In addition, the safety characteristics of the safe PLC used must be included in the safety evaluation of the safety function.

Safety ratings for pressure-sensitive mat applications	
Highest safety integrity level to EN 62061:2010	SIL3
Highest safety integrity level to IEC 61508:2010	SIL3
Category and highest performance level to EN ISO 13849-1:2015	Cat. 3/PL e
Hardware fault tolerance (HFT) of two-channel application (IEC 61508:2010/EN)	1 (a fault of the application need not cause the safeguard to fail)

	NOTE
	<p>Lay the feed lines of pressure-sensitive mats and bumpers together <i>In order to avoid influences and malfunctions due to EMC effects, lay the four wires (e.g. SI0, SI0 TP, SI1, SI1 TP) together.</i></p>

	CAUTION
	<p>"Short circuit in mat" fault is not detected</p> <p>The safe I/O module fails to detect a short circuit between the mat contacts. This is interpreted as the mat being actuated. You must also verify that the safeguard is wired correctly.</p> <p>⇒ Periodically check that the mat is working properly.</p>

	CAUTION
	<p>Safety function pressure-sensitive mat requires a response time of 50 ms</p> <p>Avoid personal injury and damage to property</p> <p>⇒ The pressure-sensitive mat function achieves a response time of 50 ms between a change in mat state and providing the information on the EtherCAT bus.</p>

7.6 Connecting Two Actuators with Internal GND Reference

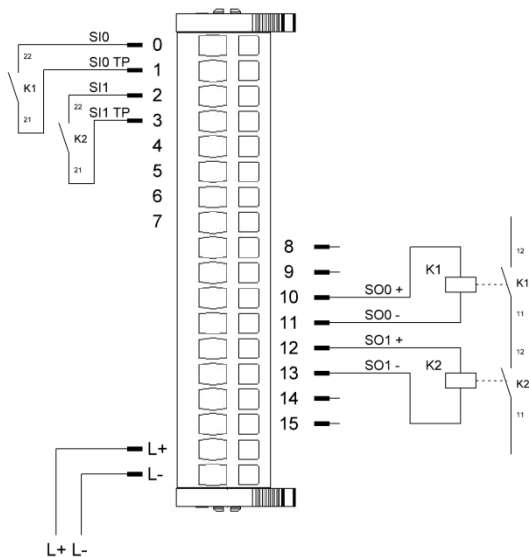

The wiring example illustrates how two outputs of the safe I/O module are used to actuate a safety function. Switch contacts K1 and K2 both affect the safety function together. Using the SOX terminals of the outputs allows the actuator to separate from the GND connection and, thus, change to its safe state when external power is supplied to an cross-faults affect the actuator (contact SOX+). Whereas you may set up this circuit without the SOX- terminals, you must ensure that external power and cross-faults are excluded if you do.

In order to monitor the relay states, you must connect the positively drive n.c. contacts of K1 and K2 to safe digital inputs. Set the safe PLC to analyse the values returned and, thus, the states of the switching devices.

S

lect the maximum values a two-channel safety function may achieve when using two outputs of the safe I/O module. They solely apply to the part of the safety function covered by the safe I/O module. All components involved in the safety function must be taken into account in order to assess whether the desired safety ratings are achieved. The quality of the safe actuator is of crucial importance with particular regard to the safety function of analysing a two-channel actuator. Only use approved actuators in due consideration of their B10d value. The safety assessment of the safety function must also consider the safety ratings of the safe PLC used in the application.

Safety ratings of applications using two outputs for a safety function	
Highest safety integrity level to EN 62061:2010	SIL3
Highest safety integrity level to IEC 61508:2010	SIL3
Category and highest performance level to EN ISO 13849-1:2015	Cat. 3/PL e
Hardware fault tolerance (HFT) in two-channel application (IEC 61508:2010/EN)	1 (a fault of the application cannot cause the safeguard to fail)

7.7 Connecting Two Parallel Actuators to One Safe Output

	<p>CAUTION</p>
<p>Consideration of the parameterization</p> <p><i>For single-channel applications (inputs and outputs), the test pulse frequency should be adapted to the application. It must be ensured that in applications in which a frequent change of state occurs, the test pulse frequency is selected at least 100 times greater than the state change time of the application.</i></p> <p>⇒ See FSoE Parameters 6.3.2</p>	

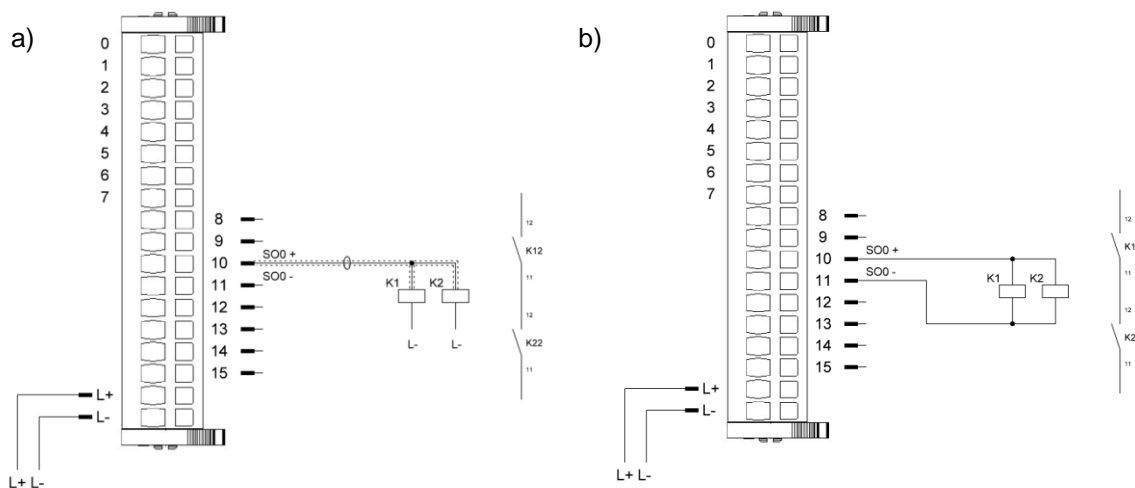

The wiring example illustrates how one output of the safe I/O module is used to actuate a safety function. Use a two-channel actuator to achieve the safety integrity levels of the table below. Before connecting it to the I/O module, verify that short circuits and cross-faults on the connecting lead are excluded.

	<p>Note, information Image a)</p>
<p>Fault prevention required!</p> <p>Take the actions required to prevent a short circuit or cross-fault on the lead connecting the FIO Safety I/O module's contact and the safe actuators.</p>	

	<p>Note, information Image b)</p>
<p>Fault prevention required!</p> <p>In order to detect faults in the wiring, it is necessary to activate the test pulses for the corresponding output.</p>	

	<p>CAUTION</p>
<p>Consider the fault detection time!</p> <p><i>The setup needs 5 ms to detect a fault. Faults may therefore produce high impulses of this width. Use a two-channel connection of the outputs in case your application responds to these impulses.</i></p>	

In order to monitor the relay states, you must connect the positively drive n.c. contacts of K1 and K2 to safe digital inputs. Set the safe PLC to analyse the values returned and, thus, the states of the switching devices.

Best safety ratings of applications using one output for a safety function

Highest safety integrity level to EN 62061:2010	SIL3
Highest safety integrity level to IEC 61508:2010	SIL3
Category and highest performance level to EN ISO 13849-1:2015	Cat. 3/PL e
Hardware fault tolerance (HFT) of single-channel application (IEC 61508:2010/EN)	1 (a fault of the application does not cause the safeguard to fail)

8 Appendix

8.1 Object Dictionary

8.1.1 Device Type 1000_h

Name	Device Type
Index	1000 _h
Object Code	VARIABLE
No. of Elements	0
Data Type	UNSIGNED32
Access	read only
PDO Mapping	no
Value Range	set
Default Value	1389 _h

8.1.2 Error Register 1001_h

Name	Error Register
Index	1001 _h
Object Code	VARIABLE
No. of Elements	0
Data Type	UNSIGNED8
Access	read only
PDO Mapping	No, TX-PDO
Default Value	00 _h

In case of an error, the associated error bit is set.

7	6	5	4	3	2	1	0
RES	RES	PROF	COM	TEMP	VOL	CUR	GEN

GEN: Generic fault	non-acknowledgeable, power cycle required
CUR: Current	non-acknowledgeable, power cycle required
VOL: Voltage	acknowledgeable via EtherCAT or by power cycle
TEMP: Temperature	non-acknowledgeable, power cycle required
COM: Communication	non-acknowledgeable, power cycle required
PROF: Device profile	acknowledgeable via EtherCAT
RES: Reserved, always "0"	non-acknowledgeable, power cycle required

8.1.3 Manufacturer Device Name 1008_h

Name	Manufacturer Device Name
Index	1008 _h
Object Code	VARIABLE
No. of Elements	0
Data Type	VISIBLE_STRING (27)
BitSize	216
Access	read only
PDO Mapping	no

Value Range	set
Default Value	Kuhnke FIO Safety SDI4/SDO2

Subindex 0 of this object contains the string length. Subindex 1 contains each of the characters. The character string has no terminating zero.

8.1.4 Manufacturer Hardware Version 1009h

Name	Manufacturer Hardware Version
Index	1009h
Object Code	VARIABLE
No. of Elements	0
Data Type	VISIBLE_STRING (4)
BitSize	32
Access	read only
PDO Mapping	no
Value Range	set
Default Value	322E3130 (2.10)

8.1.5 Manufacturer Software Version 100Ah

Name	Manufacturer Software Version
Index	100Ah
Object Code	VARIABLE
No. of Elements	0
Data Type	VISIBLE_STRING (4)
BitSize	32
Access	read only
PDO Mapping	no
Value Range	set
Default Value	312E3030 (1.00)

8.1.6 Identity Object 1018h

Name	Identity Object
Index	1018h
Object Code	RECORD
No. of Elements	5
Data Type	IDENTITY

Name	Highest Sub-index Supported
Subindex	00h
Data Type	UNSIGNED8
Access	read only
PDO Mapping	no
Default Value	>4<

Name	Vendor ID
Subindex	01h

Data Type	UNSIGNED32
Access	read only
PDO Mapping	no
Default Value	0048554B _h

Name	Product Code
Subindex	02 _h
Data Type	UNSIGNED32
Access	read only
PDO Mapping	no
Default Value	0x2B487 _h (177287)

Name	Revision Number
Subindex	03 _h
Data Type	UNSIGNED32
Access	read only
PDO Mapping	no
Default Value	0000002A _h (42)

Name	Serial Number
Subindex	04 _h
Data Type	UNSIGNED32
Access	read only
PDO Mapping	no
Units	YY MM DD NNNNN yyyyyy mmmm dddd nnnnnnnnnnnnnnnn 6-bit 4-bit 5-bit 17-bit Year 2014 is coded as '0'.
Value Range	14 01 01 00001 (0x00420001) ... 77 12 31 99999 (0xFF3F869F)
Example	16052300001 ⇔ 0x096E0001

The object contains details of the manufacturer, the product code and the revision and serial number.

8.1.7 Supply 24V Voltage 2001_h for μ C1 and 2011_h for μ C2

Name	Supply24Voltage
Index	2000 _h
Object Code	VARIABLE
No. of Elements	0
Data Type	UNSIGNED16
Access	Read
PDO Mapping	no
Units	mV
Value Range	0 ... 65535
Default Value	No default value

8.1.8 Out 1 Current 2005_h for μ C1 and 2015_h for μ C2

Name	Out1Current
Index	2005 _h
Object Code	VARIABLE
No. of Elements	0
Data Type	UNSIGNED16
Access	Read
PDO Mapping	no
Units	mA
Value Range	0 ... 2400
Default Value	No default value

8.1.9 Ext Temperature 2006_h for μ C1

Name	Ext Temperature
Index	2006 _h
Object Code	VARIABLE
No. of Elements	0
Data Type	UNSIGNED32
Access	Read
PDO Mapping	no
Units	0,01 °C
Value Range	0 ... 8000
Default Value	No default Value

**Note, Information**

To get the temperature displayed, only the least significant 16-bit can be evaluated.

8.1.10 Err.code 2007_h for μ C1 and 2017_h for μ C2

Name	Err.code
Index	2007 _h
Object Code	VARIABLE
No. of Elements	0
Data Type	UNSIGNED16
Access	Read
PDO Mapping	no
Default Value	00000000 _h

The table below explains the entries in object 2007_h or 2017_h "Err.code".

Id	Hex	Explanation
0	0x0000	OK: No error
1	0x0001	HWT_PARAMETER_ERROR Hardware test parameter error

Id	Hex	Explanation
2	0x0002	HWT_INIT_ERROR Hardware test initialisation error
100	0x0064	HWT_MEM_MARCHC_ERROR Hardware test RAM check error
101	0x0065	HWT_MEM_GALPAT_ERROR Hardware test RAM check error
200	0x00C8	HWT_STACK_UNDERFLOW_ERROR Hardware test stack underflow
201	0x00C9	HWT_STACK_OVERFLOW_ERROR Hardware test stack underflow
300	0x012C	HWT_CPU_ERROR Hardware test CPU error
400	0x0190	WT_FW_ERROR Hardware test firmware error
500	0x01F4	HWT_FWINTERFACE_ERROR Hardware test firmware error
504	0x01F8	HWT_ADC_ERROR: Test handler: error in ADC value range checks
505	0x01F9	HWT_DMA_ERROR: Test handler: DMA checksum error
506	0x01FA	HWT_CRC_ERROR: Test handler: CRC check error
507	0x01FB	HWT_TIMER_ERROR: Test handler: CPU timer check error
508	0x01FC	HWT_CLOCK_ERROR: Test handler: CPU clock signal check error
509	0x01FD	HWT_SOFTERROR: Soft error detected in hardware test
510	0x01FE	HWT_DIVZERO: Division by 0 detected in hardware test
512	0x0200	TIMEOUT_ERR: Software timeout detected
513	0x0201	OUT_OF_RANGE_ERR: Parameter or value out of allowed range
514	0x0202	OVERWRITE_ERR: Register buffer data overwritten
515	0x0203	UNDERFLOW_ERR: Register buffer data underflow
516	0x0204	PRG_CNTRL_ERR: Program sequence control error detected
528	0x0210	INIT_ERROR: Initialization error
592	0x0250	ASSERT_TRUE_ERR: Assertion of expression = "true" failed
593	0x0251	ASSERT_NOT_NULL_ERR: Assertion of unequal to NULL failed
594	0x0252	ASSERT_GE_ERR: Assertion of ">=" comparison failed
595	0x0253	ASSERT_GT_ERR: Assertion of ">" comparison failed
596	0x0254	ASSERT_LE_ERR: Assertion of "<=" comparison failed
597	0x0255	ASSERT_LT_ERR: Assertion of "<" comparison failed
598	0x0256	ASSERT_NE_ERR: Assertion of "<>" comparison failed
599	0x0257	ASSERT_EQ_ERR: Assertion of "=" comparison failed
600	0x0258	ASSERT_FALSE_ERR: Assertion of expression = "false" failed
640	0x0280	TP_OUT_NOT_SPECIFIED: Bad output test pulse - internal sequence error (ErrReg: 32)
641	0x0281	TP_OUT_NOT_RECOGNIZED: Output test pulse not detected (ErrReg: 32)
642	0x0282	TP_OUT_NOT_ACTIVE: Output test pulse not enabled (ErrReg: 32)
656	0x0290	TP_INP_BUSY: Input test pulse operation is busy (ErrReg: 32) input test pulse monitoring not completed before a new test pulse occurred
657	0x0291	TP_INP_CROSSTALK: Input test pulse cross talk detected (ErrReg: 32)
658	0x0292	TP_INP_NOT_RECOGNIZED: Input test pulse not detected (ErrReg: 32)
659	0x0293	TP_INTINP_NOT_RECOGNIZED: Internal input test pulse not detected (ErrReg: 32)

Id	Hex	Explanation
660	0x0294	TP_INP_LOST: Internal input test pulse lost (ErrReg: 32)
661	0x0295	TP_INVALID_COUNT_FOR_SELECTOR: Test pulse error in mode selector mode (ErrReg: 32)
662	0x0296	TP_INVALID_OUTPUT_WIRING
672	0x02A0	MRAM_NOT_INITIALIZED
673	0x02A1	MRAM_READ_ERR: MRAM Read error
674	0x02A2	MRAM_WRITE_ERR: MRAM write error
675	0x02A3	MRAM_INDEX_OUT_OF_RANGE: MRAM address index out of valid range
676	0x02A4	MRAM_CORRUPT_PAGE_SIZE: MRAM invalid page size
677	0x02A5	MRAM_CRC_ERR: MRAM data CRC check failed
678	0x02A6	MRAM_MAGICNUMBER_ERR: MRAM magic number not recognized
768	0x0300	RESET_LOW_POWER: Reset due to low power supply
769	0x0301	RESET_WINDOW_WD: Reset by window watchdog
770	0x0302	RESET_INDEPENDENT_WD: Reset by independent watchdog timer
771	0x0303	RESET_SW: Reset by software reset
772	0x0304	RESET_POWER_ON_DOWN: Reset by power up or down
773	0x0305	RESET_NMI: Reset by non-maskable interrupt
774	0x0306	RESET_BROWNOUT: Reset by CPU brown out detection
775	0x0307	RESET_NO_REASON: Reset for unknown reason
1024	0x0400	ADC_REF_LOW: ADC reference voltage too low
1025	0x0401	ADC_REF_HIGH: ADC reference voltage too high
1026	0x0402	ADC_24V_LOW: 24 V ADC supply voltage too low (< 24V - 10%) (ErrReg: 4)
1027	0x0403	ADC_24V_HIGH: 24 V ADC supply voltage too high (> 24V + 15%) (ErrReg: 4)
1028	0x0404	ADC_5V_LOW: Internal 5 V supply voltage too low (ErrReg: 4)
1029	0x0405	ADC_5V_HIGH: Internal 5 V supply voltage too high (ErrReg: 4)
1030	0x0406	ADC_3_3V_LOW: Internal 3.3 V supply voltage too low
1031	0x0407	ADC_3_3V_HIGH: Internal 3.3 V supply voltage too high
1032	0x0408	ADC_TEMP_LOW: On-chip temperature too low (ErrReg: 8)
1033	0x0409	ADC_TEMP_HIGH: On-chip temperature too high (ErrReg: 8)
1034	0x040A	ADC_CURR_HIGH: Total output current too high (ErrReg: 2)
1035	0x040B	ADC_24V_FATAL: 24 V ADC supply voltage much too high (> 60V) (ErrReg: 4)
1280	0x0500	LINE_TIMEOUT: Sync line level monitoring timeout from base board
1281	0x0501	NOVALIDCPUID: Invalid CPU identifier setting
1282	0x0502	TIMEOUTTIMERERR: Timeout timer error
1283	0x0503	DIPSWITCHREADERR: DIP switch could not be read
1284	0x0504	DIPSWITCHCHANGED: DIP switch setting changed in service
1285	0x0505	DIPSWITCHXCHGERROR: CPU-to-CPU exchange of address DIP settings failed
1286	0x0506	DIPSWITCH_INVALID_ADDRESS: Invalid FSoE address selected (address = 0) (ErrReg: 32)
1312	0x0520	CLK_ERROR: Partner clock frequency out of valid range
1313	0x0521	CLK_PARTNER_LOW: Partner clock frequency too low
1314	0x0522	CLK_PARTNER_HIGH: Partner clock frequency too high
1328	0x0530	HW_REVISION_ERROR: Invalid PCB HW revision detected (the SW currently running not designed for this HW revision)
1536	0x0600	INPUTXCHGERROR: CPU-to-CPU exchange of safety input information failed

Id	Hex	Explanation
1537	0x0601	INPUT_TIMEOUT: Input test pulse timed out (ErrReg: 32)
1552	0x0610	INPUT_EXTMATTE_KS: Short circuit detected in external safety input carpet (ErrReg: 32) not used
1553	0x0611	INPUT_EXTMATTE_OPEN: Safety mat not connected / open load, short circuit or wire failure (ErrReg: 32)
1792	0x0700	OUTPUTXCHGERROR: CPU-to-CPU exchange of safety output information failed
1793	0x0701	OUTPUTFAIL: Output test pulse not detected (ErrReg: 32)
1794	0x0702	OUTPUT_WAITFB: Output test pulse waiting for feedback signal (ErrReg: 32)
1795	0x0703	OUTPUT_TIMEOUT: Timeout in handling of output (ErrReg: 32)
1796	0x0704	OUTPUT_HSTP_TIMEOUT: Output test pulse of high side switch timed out
1797	0x0705	OUTPUT_LSTP_TIMEOUT: Output test pulse of low side switch timed out
1798	0x0706	OUTPUT_LSTP_CONNECT_ERR: Output test pulse of low side switch timed out Bad wiring - output set to external ground, wrong signal detected on feedback line
1799	0x0707	OUTPUT_USTP_TIMEOUT: Output test pulse of common high side switch timed out
1800	0x0708	OUTPUT_NOPAR_USED: Output is parameterized as not used and shall be switched on (ErrReg: 32)
2048	0x0800	BCOM_NOTREADY: Communication with base board not ready / operational
2049	0x0801	BCOM_BUSY: Communication with base board is busy
2050	0x0802	BCOM_NONEWDATA: Communication with base board - no new data received
2051	0x0803	BCOM_CRCERR: Communication with base board – CRC error
2052	0x0804	BCOM_BITERR: Communication with base board – shifted bits detected
2304	0x0900	XCOM_NOTREADY: Communication with safety partner MC not ready / operational
2305	0x0901	XCOM_BUSY: Communication with safety partner MC is busy
2306	0x0902	XCOM_NONEWDATA: Communication with safety partner MC – no new data received
2307	0x0903	XCOM_CRCERR: Communication with safety partner MC – CRC error detected
2560	0x0A00	I2C_TIMEOUT: I2C communication timeout detected
2561	0x0A01	I2C_BUSY: I2C bus is busy
2816	0x0B00	FSOE_RESET_IND: Test pulse error in mode selector mode (ErrReg: 16) FailSafeOverEtherCAT – FSoE slave returns error to FSoE master
2817	0x0B01	FSOE_INVALID_CMD: Test pulse error in mode selector mode (ErrReg: 16) FailSafeOverEtherCAT – invalid command
2818	0x0B02	FSOE_UNKNOWN_CMD: Test pulse error in mode selector mode (ErrReg: 16) FailSafeOverEtherCAT – unknown command
2819	0x0B03	FSOE_INVALID_CONNID: Test pulse error in mode selector mode (ErrReg: 16) FailSafeOverEtherCAT – invalid connection ID
2820	0x0B04	FSOE_INVALID_CRC: Test pulse error in mode selector mode (ErrReg: 16) FailSafeOverEtherCAT – checksum error
2821	0x0B05	FSOE_WD_EXPIRED: Test pulse error in mode selector mode (ErrReg: 16) FailSafeOverEtherCAT – Watchdog time out
2822	0x0B06	FSOE_INVALID_ADDRESS: Test pulse error in mode selector mode (ErrReg: 16) FailSafeOverEtherCAT – invalid address
2823	0x0B07	FSOE_INVALID_DATA: Test pulse error in mode selector mode (ErrReg: 16) FailSafeOverEtherCAT – invalid data

Id	Hex	Explanation
2824	0x0B08	FSoE_INVALID_COMMPARALEN: Test pulse error in mode selector mode (ErrReg: 16) FailSafeOverEtherCAT – invalid length of communication parameters
2825	0x0B09	FSoE_INVALID_COMMPARA: Test pulse error in mode selector mode (ErrReg: 16) FailSafeOverEtherCAT – invalid communication parameters
2826	0x0B0A	FSoE_INVALID_USERPARALEN: Test pulse error in mode selector mode (ErrReg: 16) FailSafeOverEtherCAT – invalid length of user parameters
2827	0x0B0B	FSoE_INVALID_USERPARA: Test pulse error in mode selector mode (ErrReg: 16) FailSafeOverEtherCAT – invalid user parameters
2828	0x0B0C	FSoE_INVALID_TP_INP_DURATION: FailSafeOverEtherCAT – invalid safety input parameter test pulse duration (ErrReg: 16)
2829	0x0B0D	FSoE_INVALID_TP_INP_FREQUENCY: FailSafeOverEtherCAT – invalid safety input test pulse frequency (ErrReg: 16)
2830	0x0B0E	FSoE_INVALID_TP_OUT_DURATION: FailSafeOverEtherCAT – invalid safety output parameter test pulse duration (ErrReg: 16)
2831	0x0B0F	FSoE_INVALID_TP_OUT_FREQUENCY: FailSafeOverEtherCAT – invalid safety output test pulse frequency (ErrReg: 16)
2832	0x0B10	FSoE_INVALID_WATCHDOG_TIME: FailSafeOverEtherCAT – invalid safety parameter watchdog time (ErrReg: 16)
2833	0x0B11	FSoE_INVALID_INP_EXT_SUPPLY: FailSafeOverEtherCAT – invalid safety parameter for inputs having external supply (ErrReg: 16) or inputs not used according to parameter setup
2834	0x0B12	FSoE_INVALID_INP_IN_USE: FailSafeOverEtherCAT – invalid safety parameter for inputs in use (ErrReg: 16)
2835	0x0B13	FSoE_INVALID_INP_USED_EXT_MISMATCH: FailSafeOverEtherCAT – mismatch of safety parameters for inputs in use and externally supplied inputs (ErrReg: 16)
2836	0x0B14	FSoE_INVALID_OUT_IN_USE: FailSafeOverEtherCAT – invalid safety parameter for outputs in use (ErrReg: 16)
2837	0x0B15	FSoE_INVALID_OUT_USED_EXT_MISMATCH: FailSafeOverEtherCAT – mismatch of safety parameters for outputs in use and externally earthed outputs (ErrReg: 16)
2944	0x0B80	FSoE_EXTENDED_ERROR: FailSafeOverEtherCAT – test pulse error in mode selector mode, extended error (ErrReg: 16)
2992	0x0BB0	FSoE_ERROR: FailSafeOverEtherCAT – invalid internal state in safety stack (ErrReg: 16)
3072	0x0C00	TH_GLOBAL_ERROR: Global hardware test error
3073	0x0C01	TH_TIMEOUT: Internal hardware test sequence timeout
3329	0x0D01	MC1_ID_INVALID: Identification of MC 1 failed
3330	0x0D02	MC2_ID_INVALID: Identification of MC 2 failed
3331	0x0D03	MC3_ID_INVALID: Identification of MC 3 failed
3584	0x0E00	FOREIGN_ERROR_DETECTED: Error detected by other MC
3841	0x0F01	FLASH_TIMEOUT: Timeout writing to FLASH
3842	0x0F02	FLASH_LOCKED: FLASH operation failed because "LOCK" bit could not be reset
3851	0x0F0B	FLASH_BUSY: FLASH operation busy, sequence error in FLASH programming
3854	0x0F0E	FLASH_ERROR: FLASH operation error, programmer the FLAH memory failed

8.1.11 Err.line 2008_h for μ C1 and 2018_h for μ C2

Name	Err.line CPU 1/2
Index	2008 _h
Object Code	VARIABLE
No. of Elements	0
Data Type	UNSIGNED16
Access	Read
PDO Mapping	no
Default Value	00000000 _h

8.1.12 Err.module 2009_h for μ C1 and 2019_h for μ C2

Name	Err.module CPU 1/2
Index	2009 _h
Object Code	VARIABLE
No. of Elements	0
Data Type	UNSIGNED8
Access	Read
PDO Mapping	no
Default Value	00000000 _h

The table below explains the entries in object 2009_h or 2019_h "Err.module".

Id	Explanation
0	OBJ_UNKNOWN_ID – unknown module
4	OBJ_FSOETASK_ID – error occurred in "CFSoETask.cpp"
8	OBJ_INPUT_ID - error occurred in "CInput.cpp"
12	OBJ_MAINTASK_ID - error occurred in "CMainTask.cpp"
16	OBJ_PRGCONTRLTASK_ID - error occurred in "CProgramControlTask.cpp"
20	OBJ_SYNCSAFETYPARTNER_ID - error occurred in "CSyncSafetyPartner.cpp"
24	OBJ_XCOM_ID - error occurred in "CXCom.cpp"
28	OBJ_SAFETYHAL_ID - error occurred in "CSafetyHal.cpp"
32	OBJ_YSTIMER_ID - error occurred in "CysTimer.cpp"
36	OBJ_MSTIMER_ID - error occurred in "CmsTimer.cpp"
44	OBJ_BASEBOARDCOM_ID - error occurred in "CBaseBoardComm.cpp"
48	OBJ_DIPSWITCH_ID - error occurred in "CDIPSwitch.cpp"
52	OBJ_HELPER_ID - error occurred in "CHelper.cpp"
56	OBJ_SYNCLINE_ID - error occurred in "CSyncSafetyPartner.cpp"
60	OBJ_TIMETABLE_ID - error occurred in "CTimeTableManager.cpp"
64	OBJ_TESTHANDLER_ID - error occurred in "CTestHandler.cpp"

Id	Explanation
80	OBJ_TIME_ITERATOR_ID - error occurred in "CTimeTableIterator.cpp"
96	OBJ_SPI_ID - error occurred in "CSpi.cpp"
97	OBJ_TIMER_ID - error occurred in "CTimer.cpp"
98	OBJ_BACKUPSRAM_ID - error occurred in "CBackupSRam.cpp"
99	OBJ_PWR_ID - error occurred in "CPwr.cpp"
100	OBJ_RCC_ID - error occurred in "CRcc.cpp"
101	OBJ_GPIO_ID - error occurred in "OBJ_GPIO_ID"
102	OBJ_DMASTREAM_ID - error occurred in "CDmaStream.cpp"
103	OBJ_ADC_ID - error occurred in "CAdc.cpp"
104	OBJ_WD_ID - error occurred in "CWatchdog.cpp"
105	OBJ_FLASH_ID - error occurred in "CFlash.cpp"
106	OBJ_I2C_ID - error occurred in "CI2c.cpp"
128	OBJ_INPUTHANDLER_ID - error occurred in "CInputHandler.cpp (Safe-In 1) "
129	OBJ_INPUTHANDLER_ID - error occurred in "CInputHandler.cpp (Safe-In 2) "
130	OBJ_INPUTHANDLER_ID - error occurred in "CInputHandler.cpp (Safe-In 3)"
131	OBJ_INPUTHANDLER_ID - error occurred in "CInputHandler.cpp (Safe-In 4)"
144	OBJ_OUTPUT_ID - error occurred in "COutput.cpp (Safe-Out 1)"
145	OBJ_OUTPUT_ID - error occurred in "COutput.cpp (Safe-Out 2)"
148	OBJ_USTESTPULSE_ID - error occurred in "CUSTestOuls.cpp"
160	OBJ_OUTPUHANDLER_ID - error occurred in "COutputHandler.cpp"
164	OBJ_OUTPFSWITCH_ID - error occurred in "COutpFSSwitch.cpp"

8.1.13 Err.class 200A_h for μ C1 and 201A_h for μ C2

Name	Err.class CPU 1/2
Index	200A _h
Object Code	VARIABLE
No. of Elements	0
Data Type	UNSIGNED8
Access	Read
PDO Mapping	no
Default Value	00000000 _h

The table below explains the entries in object 200A_h or 201A_h "Err.class".

Id	Explanation
0	No error
1	Serious or synchronization error

Id	Explanation
2	Internal communication error
3	I/O error
4	Error in ErrorHandler or at the outputs
5	Fatal error

8.1.14 System Uptime [s] 200C_h

Name	System uptime [s] (implicit MRAM test)
Index	200C _h
Object Code	VARIABLE
No. of Elements	0
Data Type	UNSIGNED32
Access	Read
PDO Mapping	no
Units	sec
Default Value	No default Value

8.1.15 Temperature Warning 0x2016_h

Name	Temperature warning
Index	2016 _h
Object Code	VARIABLE
No. of Elements	0
Data Type	UNSIGNED8
Access	Read
PDO Mapping	no
Value	0°C – 55°C = 0; <0°C or >55°C = 1
Default Value	No default value

8.1.16 Objects - For Internal Use Only

The objects listed below are not intended for use by the end user. Some of them are used for configuring and their values cannot be retrieved.

0x10F1h	Error Settings
0x1600h	FSOE Rx PDO Mapping
0x1A00h	FSOE Tx PDO Mapping
0x1C00h	Sync Manager Type
0x1C12h	Rx PDO Assign
0x1C13h	Tx PDO Assign
0x1C32h	SM Output Parameter
0x1C33h	SM Input Parameter
0x2000h	Ref Voltage for μC1
0x2010h	Ref Voltage for μC2
0x2002h	Supply 5 Voltage to μC1
0x2012h	Supply 5 Voltage to μC2
0x2003h	Supply 3.3 Voltage to μC1
0x2013h	Supply 3,3 Voltage to μC2
0x2004h	IC Temperature (Uncalibrated) for μC1
0x2014h	IC Temperature (Uncalibrated) for μC2

0x200Bh	Number of CORA Test Cycles of μ C1
0x201Bh	Number of CORA Test Cycles of μ C2
0x2020h	MaxAsicDataUnequalCounter
0x2220h	MC1 Main Loop Cycle Time
0x2221h	MC2 Main Loop Cycle Time
0x5001h	Id MC1
0x5002h	Id MC2
0x5003h	Id MC3
0x6000h	FSOE Slave Frame Elements
0x6001h	FSOE Inputs
0x7000h	FSOE Master Frame Elements
0x7001h	FSOE Outputs
0x8000h	Input Parameter
0x8001h	Output Parameter
0x8002h	Test Pulse Duration
0x8003h	Test Frequency
0x9001h	FSOE Communication Parameter
0xF980h	Safe Address

8.2 Standards Complied With

8.2.1 Product Standard Applied

- EN 61131-2:2007
Programmable logic controllers – Part 2: Equipment requirements and tests

8.2.2 Safety Standards and Directives

- IEC 61508:2010 Parts 1-7
Functional safety of electrical/electronic/programmable electronic safety-related systems
- EN ISO 13849-1:2015
Safety of machinery – Safety-related parts of control systems
Part 1: General principles for design
- EN 62061:2005 + AC:2010 + A1:2013 + A2:2015
Safety of machinery - Functional safety of electrical, electronic and programmable electronic safety-related control systems
- EN 60204-1:2006 + A1:2009 + AC:2010 (excerpts)
Safety of machinery – Safety-related parts of control systems -
Part 1: General principles for design

8.2.3 EMC Standards

EMC immunity to:

- Generic standard DIN EN 61000-6-2:2005
Electromagnetic compatibility (EMC) – Part 6-2: Generic standards - Immunity for industrial environments
- Product standard DIN EN 61131-2:2007
Programmable logic controllers – Part 2: Equipment requirements and tests

Elevated immunity levels of safety-related applications:

- DIN EN 61326-3-1:2008
Electrical equipment for measurement, control and laboratory use - EMC requirements – Part 3-1: Immunity requirements for safety-related systems and for equipment intended to perform safety-related functions (functional safety) – General industrial applications



EMC noise emission to:

- Generic standard DIN EN 61000-6-4:2007
Electromagnetic compatibility (EMC) – Part 6-4: Generic standards – Emission standard for industrial environments
- Product standard EN 61131-2:2007
Programmable logic controllers – Part 2: Equipment requirements and tests

8.3 Regulations and Declarations

8.3.1 Mark of Conformity

The original EC-Declaration of Conformity and the associated documentation can be made available to the competent authorities. Please contact the Project Management, as necessary.

 KENDRION INDUSTRIAL WE MAGNETISE THE WORLD	
Kendrion Kuhnke Automation GmbH Industrial Control Systems Lütjenburger Straße 101 • 23714 Malente Deutschland Telefon: +49 4523 402-0 Telefax: +49 4523 402-201	
<h2 style="text-align: center;">Konformitätserklärung Declaration of Conformity</h2>	
<p>Wir erklären, dass das nachfolgend bezeichnete Produkt den Bestimmungen der unten markierten EG- Richtlinien entspricht. We declare that the following named product conforms with the requirements of the below marked EEC Directives.</p>	
Bezeichnung/ Description	Kuhnke FIO Safety IO SDI4/SDO2
Typ/ Type	Best.-Nr. 694 430 00
Kendrion Kuhnke Ident-Nr./ Kendrion Kuhnke indentation number	186696
Angewandte Normen/ Considered standards	EN 61131-2:2007, IEC 61508:2010 Teile 1-7
Angewandte harmonisierte Normen (MRL)/ Considered harmonized standards (MD)	EN ISO 13849-1:2015, EN 62061:2005 + AC:2010 + A1:2013 + A2:2015
Benannte Stelle (bezgl. MRL 2006/42/EG)/ Notified Bodies	TÜV Rheinland Industrie Service GmbH Alboinstr. 56 12103 Berlin / Germany Tel.: +49 30 7562-1557, Fax: +49 30 7562-1370, E-Mail: industrie-service@de.tuv.com NB-Nr.: 0035
Berücksichtigte EG-Richtlinie: Considered EEC-Directives:	
<input type="checkbox"/> 2006/95/EC Niederspannungsrichtlinie/Low Voltage Directive	
<input checked="" type="checkbox"/> 2014/30/EU Elektromagnetische Verträglichkeit/ EMV/Electromagnetic compatibility EMC	
<input type="checkbox"/> 2004/104/EC Funkenstörung von Kraftfahrzeugen EMV Electromagnetic compatibility of vehicles EMC	
<input checked="" type="checkbox"/> 2011/65/EU Beschränkung der Verwendung bestimmter gefährlicher Stoffe in Elektro- und Elektronikgeräten (RoHS-2)/ Restriction of the use of certain hazardous substances in electrical and electronic equipment (RoHS-2)	
<input checked="" type="checkbox"/> 2006/42/EG Maschinenrichtlinie entsprechend Baumusterbescheinigung (01/205/5512.00/16)	
<p>Wird das Produkt in eine Maschine eingebaut oder mit anderen Maschinen zu einer Maschine zusammengebaut, so ist vor der Inbetriebnahme zu prüfen, ob die Maschine, in dieses Produkt eingebaut werden soll, den Bestimmungen der Richtlinien entspricht. If the device is mounted in a machine or assembles with other machinery to constitute a machine in front of the operation of the machine it is necessary to test that the machine itself conforms with the requirements of the directive.</p>	
Malente, 02.05.2016 Ort, Datum Place, date of issue	 _____ Entwicklungsleiter/ Development Manager
INDUSTRIAL CONTROL SYSTEMS  <small>KU-0106/0715</small>	<small>Seite 1 von 1</small>

8.3.2 TÜV Certificate

EC Type-Examination Certificate





Product Safety
Functional
Safety

www.tuv.com
ID 060000000

Reg.-Nr./No.: 01/205/5512.00/16

Prüfgegenstand Product tested	Sichere digitale Ein-/Ausgabebaugruppe mit sicherer Kommunikation über FSoE Safe digital I/O module with safety communication FSoE	Zertifikatsinhaber Certificate holder	Kendrion Kuhnke Automation GmbH Lütjenburger Str. 101 23714 Malente Germany
Typbezeichnung Type designation	Kuhnke FIO Safety SDI4 / SDO2 - 694 430 00		
Prüfgrundlagen Codes and standards	EN ISO 13849-1:2015 EN 62061:2005 + AC:2010 + A1:2013 + A2:2015 IEC 61508 Parts 1-7:2010	EN 61131-2:2007 EN 60204-1:2006 + A1:2009 + AC:2010 (in extracts)	
Bestimmungsgemäße Verwendung Intended application	Das I/O-Modul erfüllt die Anforderungen der Prüfgrundlagen (Kat. 3 / PL e nach EN ISO 13849-1, SIL CL 3 nach EN 62061 / IEC 61508) und kann in Anwendungen bis zu diesen Sicherheitsleveln eingesetzt werden. The I/O module complies with the requirements of the relevant standards (Cat. 3 / PL e acc. to EN ISO 13849-1, SIL CL 3 acc. to EN 62061 / IEC 61508) and can be used in applications up to these safety levels.		
Besondere Bedingungen Specific requirements	Die Hinweise in der zugehörigen Installations- und Betriebsanleitung sowie des Sicherheitshandbuchs sind zu beachten. The instructions of the associated Installation, Operating and Safety Manual shall be considered.		

Es wird bestätigt, dass der Prüfgegenstand mit den Anforderungen nach Anhang I der Richtlinie 2006/42/EG über Maschinen übereinstimmt.
It is confirmed, that the product tested complies with the requirements for machines defined in Annex I of the EC Directive 2006/42/EC.

Gültig bis / Valid until 2021-07-27
Der Ausstellung dieses Zertifikates liegt eine Prüfung zugrunde, deren Ergebnisse im Bericht Nr. 968/FSP 1259.00/16 vom 27.07.2016 dokumentiert sind.
Dieses Zertifikat ist nur gültig für Erzeugnisse, die mit dem Prüfgegenstand übereinstimmen. Es wird ungültig bei jeglicher Änderung der Prüfgrundlagen für den angegebenen Verwendungszweck.
The issue of this certificate is based upon an examination, whose results are documented in Report No. 968/FSP 1259.00/16 dated 2016-07-27.
This certificate is valid only for products which are identical with the product tested. It becomes invalid at any change of the codes and standards forming the basis of testing for the intended application.

Berlin, 2016-07-27

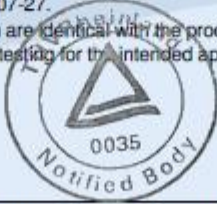

Notified Body for Machinery, NB 0035



Dipl.-Ing. Jelena Stenzel

10/222 12, 12 E A4 © TÜV, TUEV and TÜV are registered trademarks. Utilization and application requires prior approval.

TÜV Rheinland Industrie Service GmbH, Altdorfer Str. 65, 52103 Berlin / Germany
Tel.: +49 30 7962-1557, Fax: +49 30 7962-1370, E-Mail: industrie.service@os.tuv.com

www.fs-products.com
www.tuv.com

 **TÜVRheinland®**
Precisely Right.

8.4 Permits

Kuhnke's FIO Safety I/O module has been granted the following permits:



Certified for use in safety application by the German technical testing and inspection association (TÜV) to: EN ISO 13849-1:2015, EN 62061:2005 + AC:2010 + A1:2013 + A2:2015, EN 61131-2:2007, EN 60204-1:2006 + A1:2009 + AC: 2010 (extracts), IEC 61508 Parts 1-7:2010



CULUS
File number: E202287



Conformance and interoperability tests passed at an EtherCAT Test Center (ETC).



Conforms to RoHS Directive 2011/65/EU limiting the use of certain hazardous substances in electrical and electronic equipment

8.5 Order Specifications

8.5.1 Basic Units

Technical Data

Kuhnke FIO Safety SDI4 / SDO2

694 430 00

Safe input/output module

Safety protocol: FSoE

Safety standard: IEC 61508 SIL3 and DIN EN ISO 13849-1 Cat. 3 / PL e

Number of inputs: 4 safe inputs (configurable properties)

Number of outputs: 2 safe outputs (I_{max} = 2.0 A)

Test pulse outputs (OSSD): 4

Extended diagnostic information: Via CoE



8.5.2 Accessories

Technical Data

KUHNKE FIO Safety PLC

694 330 00

Safety control unit

Safety protocol: FSoE

Safety standard: IEC 61508 SIL3 and DIN EN ISO 13849-1 Cat. 3 / PL e permits CE, cULus (planned), TÜV Rheinland

Runtime system: CODESYS RT Safety

Programming tool: CODESYS v3.5 SP5 or higher with integrated safety function modules



8.5.3 Spare Parts

There are no spare parts for the FIO Safety I/O module.

You are not allowed to repair Kuhnke's FIO Safety I/O module. Please return the defective module to Kendrion Kuhnke Automation GmbH in Malente → 9 Sales & Service.

9 Sales & Service

Please visit our Internet site to find a comprehensive overview of our sales and service network including all the relevant addresses. Feel free to also contact us at our headquarters in Malente/Germany:

KENDRION
WE MAGNETISE THE WORLD

INDUSTRIAL CONTROL SYSTEMS

Home | Produkte | Branchen | Kundenspezifische Lösungen | Über uns | Aktuelles | Presse | Karriere | Kontakt

Herzlich Willkommen bei
**Kendrion Kuhnke Automation
Industrial Control Systems**

Kuhnke Steuerungstechnik
Erfahren Sie mehr! ▶

Kuhnke Magnettechnik
Erfahren Sie mehr! ▶

Kuhnke Pneumatik und Fluidtechnik
Erfahren Sie mehr! ▶

**Arriva Steuerungstechnik
Mobile Automation**
Erfahren Sie mehr! ▶

9.1.1 Malente Headquarters

Kendrion Kuhnke Automation GmbH
Industrial Control Systems
Lütjenburger Straße 101
D-23714 Malente, Germany
Tel. +49 4523 402-0
Fax +49 4523 402-201
Email sales-ics@kendrion.com
Web www.kuhnke.kendrion.com