



Safety over  
**EtherCAT**®

## User Guide

Original Operation Instructions

### Kuhnke FIO Safety IO

Sicherheitsklemme für FIO System

SDI8 SDO2 694 430 10

SDI16 SDO4 694 430 20

SDI16 694 431 00

E 857 GB / Dok.-Nr 10274001 / Version 1.2

15. Nov 2022

# Table of Contents

|       |  |    |
|-------|--|----|
| 1     | Legal Notice.....  | 6  |
| 1.1   | Contact Details .....  | 6  |
| 1.2   | Version Details.....   | 6  |
| 1.2.1 | Manual.....  | 6  |
| 1.2.2 | Kuhnke FIO Safety IO .....                                   | 6  |
| 2     | Preface .....  | 7  |
| 2.1   | About this User Guide .....                                  | 7  |
| 2.1.1 | Limitation of Liability .....                                | 7  |
| 2.1.2 | Terms of Delivery .....                                      | 7  |
| 2.1.3 | Copyright .....  | 7  |
| 2.1.4 | Warranty .....   | 7  |
| 2.2   | Reliability, Safety .....                                    | 8  |
| 2.2.1 | Applicability .....  | 8  |
| 2.2.2 | Target Group .....   | 8  |
| 2.2.3 | Reliability .....  | 8  |
| 2.2.4 | Hazard and Other Warnings .....                              | 8  |
| 2.2.5 | Other Notices .....  | 9  |
| 2.2.6 | Safety .....   | 9  |
| 2.2.7 | Project Planning and Installation.....                       | 10 |
| 2.2.8 | Maintenance and Servicing.....                               | 10 |
| 3     | System Description.....                                      | 11 |
| 3.1   | EtherCAT® – Ethernet Control.....                            | 11 |
| 3.2   | Kuhnke FIO.....  | 11 |
| 3.3   | Kuhnke FIO Safety System .....                               | 11 |
| 3.3.1 | Safety over EtherCAT (FSoE).....                             | 11 |
| 3.3.2 | Kuhnke FIO Safety PLC.....                                   | 12 |
| 3.3.3 | Kuhnke FIO Safety I/O .....                                  | 12 |
| 3.3.4 | CODESYS Safety.....  | 12 |
| 3.3.5 | CODESYS SafetyPLCopen Library .....                          | 13 |
| 4     | Product Description .....                                    | 14 |
| 4.1   | General Description .....                                    | 14 |
| 4.2   | Application .....  | 14 |
| 4.2.1 | Intended Use .....   | 14 |
| 4.2.2 | Qualified Persons .....                                      | 15 |
| 4.2.3 | Disclaimer of Liability .....                                | 15 |
| 4.3   | Safe State .....   | 15 |
| 4.3.1 | Safe Functional State .....                                  | 16 |
| 4.3.2 | Fail-Safe State – External Fault .....                       | 16 |
| 4.3.3 | Fail-Safe State – Internal Fault .....                       | 16 |
| 4.3.4 | Traceability .....   | 16 |
| 4.4   | Useful Life.....   | 16 |
| 4.5   | Technical Data.....  | 17 |
| 4.5.1 | General Specifications .....                                 | 17 |
| 4.5.2 | Safe Digital Inputs .....                                    | 18 |
| 4.5.3 | Digital Test Pulse Outputs.....                              | 19 |
| 4.5.4 | Safe Digital Outputs .....                                   | 19 |
| 4.6   | Safety-related Ratings of a Single-channel Application ..... | 20 |
| 4.7   | Safety-related Ratings of a Two-channel Application .....    | 21 |
| 4.8   | Response Time .....  | 22 |

|        |   |    |
|--------|---|----|
| 4.9    | Dimensions .....  | 24 |
| 4.10   | Transport and Storage.....  | 24 |
| 5      | Construction and Functionality .....                                  | 25 |
| 5.1    | Labelling and Identification .....                                    | 25 |
| 5.1.1  | Imprinted Texts and Symbols.....                                      | 25 |
| 5.1.2  | Serial Number .....   | 26 |
| 5.2    | Contents of Package .....   | 26 |
| 5.3    | Connectors .....  | 27 |
| 5.3.1  | E-bus and Module Lock .....   | 27 |
| 5.3.2  | Combi Plug X1 .....   | 27 |
| 5.3.3  | Kuhnke FIO Safety SDI16 SDO4 .....                                    | 28 |
| 5.3.4  | Kuhnke FIO Safety SDI16.....  | 30 |
| 5.3.5  | Kuhnke FIO Safety SDI8 SDO2 .....                                     | 32 |
| 5.3.6  | Wiring Example .....  | 33 |
| 5.4    | Indicators and Controls.....  | 34 |
| 5.4.1  | LED "EtherCAT Run" .....  | 34 |
| 5.4.2  | LED "Safe Status" .....   | 34 |
| 5.4.3  | LED "Power" .....   | 34 |
| 5.4.4  | LEDs "Channel".....   | 35 |
| 5.5    | Operating Software.....   | 40 |
| 6      | Installation and Operation.....                                       | 41 |
| 6.1    | General Notes on Installation .....                                   | 41 |
| 6.2    | Mechanical Installation .....   | 42 |
| 6.2.1  | Mounting Position.....  | 43 |
| 6.2.2  | Order of Modules in Multi-FIO Systems.....                            | 44 |
| 6.2.3  | Snapping on a Single Module .....                                     | 44 |
| 6.2.4  | Interconnecting Two Modules .....                                     | 44 |
| 6.2.5  | Disconnecting Two Modules .....                                       | 45 |
| 6.2.6  | Taking Down a Single Module .....                                     | 45 |
| 6.3    | Electrical Installation.....  | 46 |
| 6.3.1  | Earthing.....   | 46 |
| 6.3.2  | Ground connection.....  | 47 |
| 6.3.3  | Module Interconnection.....   | 48 |
| 6.3.4  | System Power Supply .....   | 48 |
| 6.3.5  | I/O Supply.....   | 48 |
| 6.3.6  | Sensor and Actuator Power Supply .....                                | 49 |
| 6.3.7  | Power Supply Wiring Example.....                                      | 49 |
| 6.3.8  | Sensor Connection.....  | 50 |
| 6.3.9  | Actuator Connection.....  | 59 |
| 6.3.10 | Derating the Modules with Reference to Their Ambient Temperature..... | 67 |
| 6.3.11 | Multiple Socket Connector (MSC).....                                  | 68 |
| 6.4    | Configuration .....   | 71 |
| 6.4.1  | Address Setup.....  | 71 |
| 6.4.2  | FSoE Parameters.....  | 72 |
| 6.4.3  | Input Parameters.....   | 77 |
| 6.4.4  | Output Parameters.....  | 78 |
| 6.5    | Putting into Service.....   | 79 |
| 6.6    | Diagnosis.....  | 82 |
| 6.6.1  | Self-test .....   | 82 |
| 6.6.2  | Kuhnke FIO Safety I/O Module Faults .....                             | 82 |

|  |     |
|--|-----|
| 6.6.3 Wrong Wiring.....  | 82  |
| 6.6.4 Temperature Faults .....   | 82  |
| 6.6.5 Wrong Supply Voltage .....   | 83  |
| 6.6.6 Table of Faults.....   | 83  |
| 6.6.7 Error Codes .....  | 84  |
| 6.6.8 EtherCAT Link Lost .....   | 84  |
| 6.6.9 Wrong FSoE Address .....   | 85  |
| 6.6.10 Wrong configuration of the Kuhnke FIO Safety module .....                                   | 85  |
| 6.7 Reset / Acknowledge Error .....  | 85  |
| 6.8 Maintenance / Servicing .....  | 86  |
| 6.8.1 General.....   | 86  |
| 6.8.2 Servicing.....   | 86  |
| 6.8.3 Preventive Maintenance.....  | 86  |
| 6.9 Replacing a Kuhnke FIO Safety I/O Module .....   | 87  |
| 6.10 Durability.....   | 88  |
| 6.10.1 Repairs / Customer Service .....  | 88  |
| 6.10.2 Warranty.....   | 88  |
| 6.10.3 Taking out of Service .....   | 88  |
| 6.10.4 Disposal.....   | 88  |
| 7 Connection Examples.....   | 89  |
| 7.1 Safety Function with Single-channel Input .....  | 90  |
| 7.2 Safety Function with Two-channel Input .....   | 91  |
| 7.3 Two-hand Actuation.....  | 92  |
| 7.4 Mode Selector, Rotary Switch .....   | 93  |
| 7.5 Safety Mats, Connecting Blocks and Bumpers .....   | 94  |
| 7.6 Connecting Two Actuators with Internal GND Reference .....                                     | 96  |
| 7.7 Connecting Two Parallel Actuators to One Safe Output .....                                     | 97  |
| 8 Appendix.....  | 100 |
| 8.1 Object Dictionary .....  | 100 |
| 8.1.1 Device Type 1000h.....   | 100 |
| 8.1.2 Error Register 1001h.....  | 100 |
| 8.1.3 Predefined Error Field 1003h .....   | 100 |
| 8.1.4 Device Name 1008h.....   | 101 |
| 8.1.5 Hardware Version 1009h .....   | 101 |
| 8.1.6 Software Version 100Ah .....   | 101 |
| 8.1.7 Identity Object 1018h .....  | 102 |
| 8.1.8 Supply 24V Voltage 2001 <sub>h</sub> for $\mu$ C1 and 2011 <sub>h</sub> for $\mu$ C2 .....   | 103 |
| 8.1.9 Supply 5 V voltage 2002 <sub>h</sub> for $\mu$ C1 and 2012 <sub>h</sub> for $\mu$ C2.....    | 103 |
| 8.1.10 Supply 3.3 V voltage 2003 <sub>h</sub> for $\mu$ C1 and 2013 <sub>h</sub> for $\mu$ C2..... | 104 |
| 8.1.11 Temperature 2004 <sub>h</sub> for $\mu$ C1 .....  | 104 |
| 8.1.12 Ext Temperature 2006 <sub>h</sub> for $\mu$ C1 .....  | 104 |
| 8.1.13 Err.code 2007 <sub>h</sub> for $\mu$ C1 and 2017 <sub>h</sub> for $\mu$ C2 .....            | 105 |
| 8.1.14 Err.pos 2008 <sub>h</sub> for $\mu$ C1 and 2018 <sub>h</sub> for $\mu$ C2 .....             | 113 |
| 8.1.15 Err.module 2009 <sub>h</sub> for $\mu$ C1 and 2019 <sub>h</sub> for $\mu$ C2 .....          | 113 |
| 8.1.16 Err.class 200A <sub>h</sub> for $\mu$ C1 and 201A <sub>h</sub> for $\mu$ C2.....            | 115 |
| 8.1.17 System Uptime [s] 200C <sub>h</sub> .....   | 116 |
| 8.1.18 ADC RefVoltage 2010 <sub>h</sub> .....  | 116 |
| 8.1.19 Ext. Temperature MC1 0x2016 <sub>h</sub> .....  | 116 |
| 8.1.20 MaxAsicDataUnequalCounter 0x2020 <sub>h</sub> .....   | 116 |
| 8.1.21 Temperature Warning 0x2026 <sub>h</sub> .....   | 117 |

- 8.1.22 Safe State 0x2055h..... 117
- 8.1.23 Fail Safe Command 0x250Eh ..... 117
- 8.2 Standards Complied With..... 119
  - 8.2.1 Product Standard Applied ..... 119
  - 8.2.2 Safety Standards and Directives..... 119
  - 8.2.3 EMC Standards ..... 119
- 8.3 Regulations and Declarations..... 120
  - 8.3.1 Mark of Conformity ..... 120
  - 8.3.2 TÜV Certificates ..... 123
- 8.4 Approvals..... 127
- 8.5 Order Specifications ..... 127
  - 8.5.1 Basic Units ..... 127
  - 8.5.2 Accessories ..... 128
  - 8.5.3 Spare Parts ..... 128
- 9 Sales & Service ..... 129
  - 9.1.1 Malente Headquarters..... 129

# 1 Legal Notice

## 1.1 Contact Details

Kendrion Kuhnke Automation GmbH  
 Industrial Control Systems  
 Lütjenburger Straße 101  
 D-23714 Malente, Germany  
 Tel. +49 4523 402-0  
 Fax +49 4523 402-201  
 Email sales-ics@kendrion.com  
 Web www.kuhnke.kendrion.com

## 1.2 Version Details

### 1.2.1 Manual

#### Modification History

| Date        | Comments / Modifications  |
|-------------|---|
| 02 Mrz 2020 | Original version / First version after certification - V1.0                     |
| 10 Jun 2021 | Removed warnings to disable test pulse outputs                                  |
| 15 Nov 2022 | Maximum output switching frequency added in chapter 4.5.4 Safe Digital Outputs. |

### 1.2.2 Kuhnke FIO Safety IO

FIO Safety SDI8 / SDO2            Order Number 694 430 10  
 FIO Safety SDI16 / SDO4        Order Number 694 430 20  
 FIO Safety SDI16                Order Number 694 431 00

The table below summarises the module releases, manual versions, production dates and the changes to the functionality.

#### Module Release

| Version | Manual     | Date              | Comments / Modifications   |
|---------|------------|-------------------|--|
| V1.0    | V0.5       | As of 09 Aug 2019 | Applies to module release V1.00<br>→ software version 1.02; hardware version V1.10 |
| V 1.01  | From V 1.0 | As of 05 Aug 2019 | Applies to module release V1.01<br>→ softwareversion 1.03; hardware version V1.10  |

## 2 Preface

### 2.1 About this User Guide

This document is the original user guide of the Kuhnke FIO Safety I/O modules specified in its title. Your module work should always be based on the correct user guide version → 1.2 Version Details.

This document is primarily directed to system designers, project engineers and device developers. It does not contain any availability information. We reserve the rights for errors, omissions and modifications. Pictures are similar.

|   |   |
|---|---|
|  | <b>Note, information</b>  |
|   | <p><b><i>Please check the ERRATA_Sheet_Safety for currently applicable safety warnings.<br/>Follow the link to our product finder to find the up-to-date version.</i></b></p> |

#### 2.1.1 Limitation of Liability

Specifications are for description only and are not to be understood as guaranteed product properties in a legal sense. Exact properties and characteristics shall be agreed in the specific contract. Claims for damages against us – on whatever grounds – are excluded, except in instances of deliberate intent or gross negligence on our part.

#### 2.1.2 Terms of Delivery

The general conditions of sales and service of Kendrion Kuhnke Automation GmbH shall apply.

#### 2.1.3 Copyright

© Kendrion Kuhnke Automation GmbH

This user guide is protected by copyright.

No part of this document may be reproduced or copied in any way or by any means except expressly permitted in writing by Kendrion Kuhnke Automation GmbH.

Microsoft®, Windows® and the Windows® logo are registered trademarks of Microsoft Corp. in the USA and other countries.

EtherCAT® is a registered brand and patented technology, licenced by Beckhoff Automation GmbH, Germany.

Safety over EtherCAT is a registered trademark and patented technology, licenced by Beckhoff Automation GmbH, Germany

Further information about the PLCopen organisation is available at [www.plcopen.org](http://www.plcopen.org). CiA® and CANopen® are registered joint brands of CAN in Automation e.V. Title to all companies and company names mentioned herein as well as to products and product names is held by the respective enterprises.

#### 2.1.4 Warranty

Warranty is subject to the provisions of the conditions of sale of Kendrion Kuhnke Automation GmbH or any contractual agreements between the parties.

The warranty will be voided by:

- improper assembly and use
- repairs or inadmissible servicing
- modifications or rendering the serial number illegible or removing it

## 2.2 Reliability, Safety

### 2.2.1 Applicability

This user guide contains all information necessary for the use of the described product (control device, control terminal, software, etc.) according to instructions.

### 2.2.2 Target Group

The user guide is written for design, project planning, servicing and commissioning experts. For proper understanding and error-free application of technical descriptions, instructions for use and particularly of notes of danger and warning, extensive knowledge of automation technology and functional safety is compulsory.

### 2.2.3 Reliability

Reliability of Kuhnke products is brought to the highest possible standards by extensive and cost-effective means in their design and manufacture.

These include:

- selecting high-quality components,
- quality agreements with our suppliers / vendors,
- actions to avoid static charges when handling MOS circuits,
- worst case planning and design of all circuits,
- visual inspections at various stages of fabrication,
- computer-aided tests of all assemblies and their interaction in the circuit,
- statistical assessment of the quality of fabrication and of all returned goods for the immediate taking of appropriate corrective actions.
- standardised returns handling process
- ISO 9001 certification

### 2.2.4 Hazard and Other Warnings

Despite the actions described in section 2.2.3 Reliability , the occurrence of faults or errors in electronic control units - even if most highly improbable - must be taken into consideration.

Please pay particular attention to the additional notices which we have marked by symbols throughout this user guide. While some of these notices make you aware of possible dangers, others are intended as a means of orientation. They are described further down below in descending order of importance.



Every alert and hazard warning is made up as follows:

**Type and source of risk**

*Potential consequences of non-observance*

⇒ Preventive measures

|  |   |
|--|---|
|  | <b>DANGER</b>   |
|  | <i>A <b>DANGER</b> warning makes you aware of an immediately hazardous situation which <b>WILL</b> cause a serious or fatal accident if not observed.</i>                           |
|  | <b>WARNING</b>  |
|  | <i>A <b>WARNING</b> makes you aware of a potentially hazardous situation which <b>MAY</b> cause a serious or fatal accident or damage to this or other devices if not observed.</i> |
|  | <b>CAUTION</b>  |
|  | <i>A <b>CAUTION</b> alert makes you aware of a potentially hazardous situation which <b>MAY</b> cause an accident or damage to this or other devices if not observed.</i>           |
|  | <b>ATTENTION</b>  |
|  | <i>An <b>ATTENTION</b> notice makes you aware of a potentially hazardous situation which <b>MAY</b> cause damage to this or other devices if not observed.</i>                      |

## 2.2.5 Other Notices

|  |  |
|--|--|
|  | <b>Note, information</b>   |
|  | <i>This symbol draws your attention to additional information concerning the use of the described product. This may include cross references to information found elsewhere (e.g. in other manuals).</i> |

## 2.2.6 Safety

Our products normally become part of larger systems or installations. The information below is intended to help you integrate the product into its environment without dangers to humans or material/equipment.

|  |  |
|--|--|
|  | <b>DANGER</b>  |
|  | <p><b>Non-compliance with the user guide</b></p> <p><i>Measures for the prevention of dangerous faults or errors may be rendered ineffective or new hazard sources created.</i></p> <ul style="list-style-type: none"> <li>• Carefully read the user guide</li> <li>• Take particular heed of the hazard warnings</li> </ul> |
|  | <b>ATTENTION</b>   |
|  | <i>The safety-related products may be used by the following persons only.</i>  |

|  |  |
|--|--|
|  | <ul style="list-style-type: none"><li>• Qualified persons who know the applicable concepts of functional safety as well as the relevant standards and regulations.</li><li>• Qualified persons who plan, design, install and put machine and system safety equipment into operation.</li></ul> |
|--|--|

|   |   |
|---|---|
|  | <b>Note, information</b>  |
|   | <i>To achieve a high degree of conceptual safety in planning and installing an electronic controller, it is essential to exactly follow the instructions given in the user guide because wrong handling could lead to rendering measures against dangers ineffective or to creating additional dangers.</i> |

## 2.2.7 Project Planning and Installation

- Emergency-off installations must comply with EN 60204/IEC 204 (VDE 0113). They must be operative at any time.
- Safety and precautions regulations for qualified applications have to be complied with.
- Please pay particular attention to the notices of warning which, at relevant places, will make you aware of possible sources of dangerous mistakes or faults.
- Relevant standards and VDE regulations are to be complied with in every case.
- Control elements are to be installed in such a way as to exclude unintended operation.
- Lay control cables such that interference (inductive or capacitive) is excluded if this interference could influence controller operation or its functionality.

## 2.2.8 Maintenance and Servicing

- Accident prevention regulations (in Germany: BGV A3 - VBG 4.0) to be observed when measuring or checking a controller after power-up. This applies to section 8 (Admissible deviations when working on parts) in particular.
- You are not allowed to repair Kuhnke's FIO Safety I/O Module. Please return the module to Kendrion Kuhnke Automation GmbH if defective.
- Modular systems: always plug or unplug modules in a power-down state. You may otherwise damage the modules or (possibly not immediately recognisably!) inhibit their functionality.

## 3 System Description

### 3.1 EtherCAT® – Ethernet Control

EtherCAT® is the most powerful Ethernet-based fieldbus system currently available on the market. EtherCAT puts up the top speed mark, and its flexible topology and simple configuration make it the perfect means of controlling extremely fast processes. To give you a clue: 1000 I/Os can be addressed in 30 µs. Because of its high performance, the simple wiring and its open protocol support, EtherCAT is often used as a fast motion control and I/O bus driven by an industrial PC or in conjunction with control technology on a smaller scale.

Its interconnections between the controller at one end and both the I/O modules and drives at the other are as fast as those of a backplane bus. EtherCAT controllers thus nearly act like centralised control systems, overcoming the issue of bus transfer times that conventional fieldbus systems are burdened with.

### 3.2 Kuhnke FIO

Kuhnke's FIO is a system of I/O modules for interconnecting the process signals in an EtherCAT network. Kuhnke FIO consists of the Kuhnke FIO bus coupler and a range of Kuhnke FIO I/O modules.

The Kuhnke FIO bus coupler converts the physical transfer technology (twisted pair) to LVDS (E-bus) and generates the system voltages required by the LVDS modules. The standard 100 Base Tx lines used for office network communications connect to the one side, the Kuhnke FIO I/O modules for the process signals connect to the other. This is how the Ethernet EtherCAT protocol is retained right through to the last I/O module.

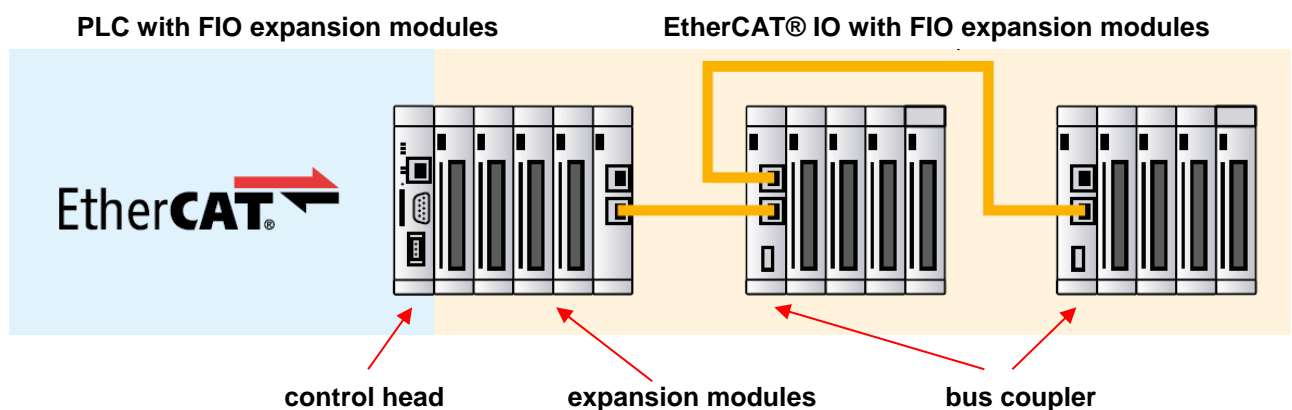

### 3.3 Kuhnke FIO Safety System

Safe inputs and outputs to expand Kuhnke's FIO module system.

Kuhnke's Safety System allows users to add FIO I/O modules with safe signals to the EtherCAT control unit, making the separate wiring of safety circuits a thing of the past. The EtherCAT protocol is used to transfer both safe and standard signals to the Kuhnke FIO Safety PLC. This integrated transfer process is based on FSoE (Fail Safe over EtherCAT), the safety protocol certified by TÜV, the German Technical Testing & Inspection Association.

#### 3.3.1 Safety over EtherCAT (FSoE)

Along with EtherCAT, a safety protocol was developed and made available for EtherCAT as "Safety over EtherCAT" (FSoE = Fail Safe over EtherCAT). It is the backbone of providing functional safety over EtherCAT. TÜV has since certified both the protocol and its implementation to comply with Safety Integrity Level 3 (SIL 3) to IEC 61508. In 2010, IEC 61784-3-12 was published as the international reference standard for Safety over EtherCAT.

Since EtherCAT is used as a single-channel medium of communication, Safety over EtherCAT does not impose any constraints regarding the transfer rate and cycle time. The transport medium is considered a "black channel" which is left out of the safety assessment.



### 3.3.2 Kuhnke FIO Safety PLC

Kuhnke's FIO Safety PLC links up the inputs and outputs of FIO Safety and other FSoE system devices. At the basic level, certified function blocks are graphically "wired up" to establish the system's safety programme. In case a project demands more than the technology of the certified blocks can provide, the extra instructions available at the extended level can be used to expand the safety programme.

FIO Safety PLC has been designed as an add-on to a normal CODESYS control unit. This is a two-channel system which uses the normal control unit to communicate with the CODESYS Development System and all non-safe I/Os. Programming is based on a certified plug-in that is fully integrated in the CODESYS Development System.

### 3.3.3 Kuhnke FIO Safety I/O

Kuhnke's FIO Safety Module provides connections for standard security appliances. It installs at any place of the FIO block. Its signals are transferred by the EtherCAT bus of a certified FSoE master (e.g. Kuhnke's FIO Safety PLC) and processed in a safe manner. The module outputs safely switch actuators such as contactors, signal lamps or servo converters.



### 3.3.4 CODESYS Safety

Programming of FIO Safety PLC is based on a certified plug-in that is fully integrated in the CODESYS Development System.

FIO Safety PLC is a sub-node of the standard control unit and provides an application, task, lists of global variables, POEs and logical I/Os.

The integrated function diagram (FD) safety editor (to IEC 61131-3, certified for use with IEC 61508 SIL3 applications) is used for basic or extended-level programming by means of certified function blocks (IEC 61131-3 or PLCopen Safety) as specified in the user manual. Further software functions are available for safeguarding the safety functions by change tracking, safe flow of signals, safe version control (pinning), separating safe operation, debugging mode, etc.



### 3.3.5 CODESYS SafetyPLCopen Library

The PLCopen components have been defined by the PLCopen organisation, its members and external organisations specialising in all safety-related aspects. Since these are certified components, they reduce the time and costs involved in developing, verifying and testing a safety application for acceptance. They interlink by logical operations which behave like logical wiring and therefore minimise the time and programming efforts needed to create major parts of safety applications.



## 4 Product Description

### 4.1 General Description

The Die Kuhnke FIO Safety modules are distributed terminals, several variants of which are available.

- Kuhnke FIO Safety SDI8 SDO2 (694 430 10)
- Kuhnke FIO Safety SDI16 SDO4 (694 430 20)
- Kuhnke FIO Safety SDI16 (694 431 00)

Figure 1: Module layout shows the basic layout of Kuhnke FIO Safety.

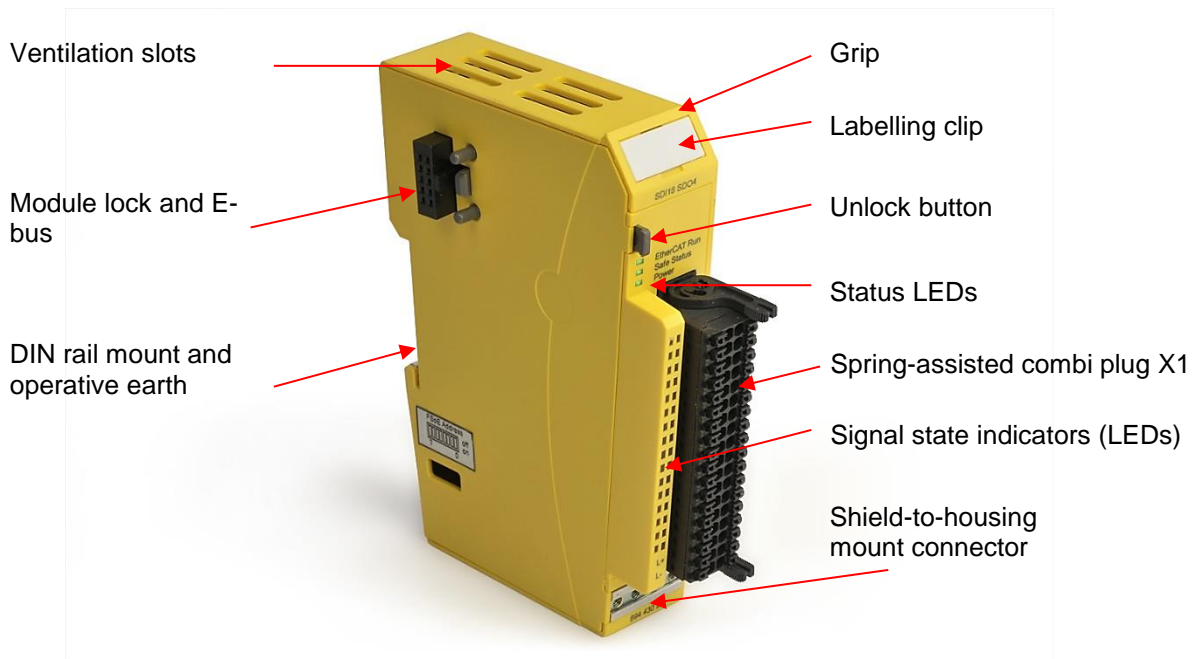

**Figure 1: Module layout**

The housing mount consists of an aluminium profile with an integrated clamping fixture used to attach the module to a 35 mm DIN rail. The housing trough including the optical fibres for the status indicators, the side faces and the front are made of plastic and contain the module. The optical fibres for the signal state indicators (LEDs) are located next to the spring-assisted combi plug. They slightly protrude from the housing and allow a clear diagnosis at a glance.

## 4.2 Application

### 4.2.1 Intended Use

Kuhnke's FIO is a system of I/O modules for interconnecting the process signals in an EtherCAT network. It consists of the bus coupler and a range of I/O modules.

The FIO Safety System comprising Kuhnke FIO Safety PLC, Kuhnke FIO Safety I/O Modules and CODESYS Safety Software make the FIO I/O system fit for the functional safety of machinery.

The intended applications of the FIO Safety System include safety functions of machines and all industrial automation tasks immediately associated with them. Thus, the system may only be used for applications providing a defined fail-safe state which, in case of the FIO Safety System, is a wattless state.

Running any of the safety-related control components is subject to the safety precautions applicable to industrial control units, i.e. guarding by emergency stop and similar safety equipment as specified by the relevant national and/or international regulations. The same applies to connected equipment such as drives or light grids. Before installing and putting the system into operation, the safety instructions, connection specifications (nameplate and documentation) and the limiting values listed in this user guide's Technical Data section must be read carefully and obeyed at any time.

The FIO Safety System is not designed for applications causing potentially fatal risks or dangers to the life and health of many persons or disastrous ecological hazards unless exceptionally strict safety precautions are taken. Such applications specifically include the monitoring of nuclear reactions in nuclear power stations as well as the control of flight or air traffic control systems, means of mass transit, medical life support systems and weapon systems.

|   |  |
|---|--|
|  | <b>Note, information</b>   |
|   | <p><b>Usage note</b></p> <p>Kuhnke's FIO Safety I/O module may be used ETG-compliant configurations with conforming products. Such products include slave services, master and development systems, and functional safety products. Check the products for the "EtherCAT Conformance tested" to see if they have passed an official test for conformity. Certified products are listed in the EtherCAT Product Guide published by the EtherCAT Technology Group.</p> |

## 4.2.2 Qualified Persons

The safety-related products may be used by the following persons only:

- Qualified persons who know the applicable concepts of functional safety as well as the relevant standards and regulations.
- Qualified persons who plan, design, install and put machine and system safety equipment into operation.

This manual's safety instructions construe qualified persons as persons whose training, experience, instructions and knowledge of the applicable standards, codes, accident prevention regulations and operating conditions authorise them to perform the required work and enable them to recognise and avoid potential hazards associated with that work. Language skills sufficient to understand this manual are therefore part of this qualification.

|   |   |
|---|---|
|  | <b>ATTENTION</b>  |
|   | <p><b><i>The safety-related products may be used by the following persons only.</i></b></p> <ul style="list-style-type: none"> <li>• Qualified persons who know the applicable concepts of functional safety as well as the relevant standards and regulations.</li> <li>• Qualified persons who plan, design, install and put machine and system safety equipment into operation.</li> </ul> |

## 4.2.3 Disclaimer of Liability

The operator is responsible for self-reliantly running the safety-related control components in conformity with the requirements set by the competent authority.

The manufacturer shall neither be held liable nor accept any warranty for damages caused by:

- inappropriate use
- non-compliance with standard and directives
- unauthorised modifications of devices, connections or settings
- use of unapproved or unsuitable equipment or equipment groups
- non-observance of the safety instructions contained in this manual

## 4.3 Safe State

There are two different types of "safe states".

The first one is functional and depends on the machine's application, operation and software. It is the aimed-for **safe functional state** at which the system works without problems.

The second one is the **fail-safe state** and applies whenever a fault or error occurs in any of the monitored components.

### 4.3.1 Safe Functional State

The system is in a safe functional state when the safe process map shows that all inputs are "null" and when the outputs reflect this "null" state by being deenergised at the output. The data frame again reflects this state by "null" in the process map.

### 4.3.2 Fail-Safe State – External Fault

In case an external fault occurs (short circuit, cross-fault etc.), all outputs are deenergised (outputs "null") and the inputs return "null" to the safe control unit. FSoE communication is not stopped.

A fail-safe state is wattless.

The safety PLC is able to reset this state.

### 4.3.3 Fail-Safe State – Internal Fault

In case of an internal module fault, all outputs are deenergised (output "null"). Both FSoE communication and the transfer of input information stops.

A fail-safe state is wattless.

Recovering from this state requires a reset by turning the supply voltage off. This involves a complete self-test as part of the initialisation phase.

|   |   |
|---|---|
|  | <b>CAUTION</b>  |
|   | <p><b><i>Uncontrolled movement of suspended loads, for example</i></b><br/> <i>Injury caused by moving or non-braked machine parts</i></p> <p>Additional external safety measures such as a mechanical brake of suspended loads should be provided for applications whose safe state requires an actuator to be actively turned on.</p> |

### 4.3.4 Traceability

Traceability means that the time and entity that produced, processed, stored, transported, consumed or disposed of a product or trading good can be traced back at any time.

Whereas Kendrion is able to meet this requirement with regard to the production, processing, storage and transport, the purchaser is responsible for all further whereabouts of the product.

The serial number on the label stuck to the underside and stored in the object dictionary is the means of distinctly identifying and tracing the product, refer to section → 5.1 Labelling and Identification. To ensure proper traceability, the purchaser is obliged to not down this number together with the machine's name, place of installation and end customer.

|   |   |
|---|---|
|  | <b>Note, information</b>  |
|   | <i>The purchaser must ensure the units' retraceability by means of their serial number.</i> |

## 4.4 Useful Life

The Kuhnke FIO Safety I/O module is designed for a maximum life of 20 years.

It must therefore be taken out of service not later than one week before the end of this 20-year period (calculated as of Kendrion Kuhnke's production date).

The production date is printed on the module as part of its serial number, see section → 5.1.2 Serial Number



## 4.5 Technical Data

### 4.5.1 General Specifications

| General Specifications                          |   |
|---|---|
| <b>Product name</b>                             | Kuhnke FIO Safety SDI8 SDO2 0.5A - part number 694 430 10<br>Kuhnke FIO Safety SDI16 SDO4 0.5A - part number 694 430 20<br>Kuhnke FIO Safety SDI16 - part number 694 431 00                 |
| <b>Fieldbus</b>                                 | EtherCAT 100Mbit/s  |
| <b>Controller</b>                               | ASIC ET1200   |
| <b>Baud rate</b>                                | 100 Mbit/s  |
| <b>E-bus port</b>                               | 10-pin system plug in side wall   |
| <b>Electrical insulation</b>                    | All modules are electrically insulated from the bus   |
| <b>Diagnosis</b>                                | LED: Bus Status, Module Status, I/O Diagnosis<br>→6.6 Diagnosis   |
| <b>IO/power connection</b>                      | Kuhnke FIO Safety SDI16 SDO4 0.5A and Kuhnke FIO Safety SDI16:<br>Push-in plug (36-pole)<br>Kuhnke FIO Safety SDI8 SDO2 0.5A:<br>18-pole spring-assisted combi plug with mechanical ejector |
| <b>E-bus load</b>                               | typ. 210 mA @ 5V (max. 300 mA)  |
| <b>Terminating module</b>                       | not required  |
| <b>Power supply (I/O / system power supply)</b> |   |
| <b>Supply voltage</b>                           | 24 VDC -15% / +20%  |
| <b>Overvoltage category</b>                     | category II to EN 61131-2   |
| <b>Module power consumption</b>                 | approx. 7 mA plus load current  |
| <b>Reverse polarity safeguard</b>               | yes   |
| <b>Nominal insulation voltage</b>               | 500 V <sub>eff</sub> measured between I/O supply and E-bus  |
| <b>Noise immunity</b>                           | Zone B to EN 61131-2,<br>mounted on earthed DIN rail in earthed control cubicle   |
| <b>Maximum interruption period (0V)</b>         | PS1 (Safe Output respond on voltage variations > 1ms)   |
| <b>Storage and transport conditions</b>         |   |
| <b>Temperature</b>                              | -40 °C ... + 70 °C  |
| <b>Rel. humidity</b>                            | 5% ... 95%, non-condensing  |
| <b>Atmospheric pressure</b>                     | 70 kPa to 108 kPa / 0 to 3000 m above msl   |
| <b>Vibration</b>                                | 5 Hz to 8.4 Hz: +/- 3.5 mm amplitude, 8.4 Hz to 150 Hz: 10 m/s <sup>2</sup> (1g),<br>to IEC 60068-2-6, Fc test  |
| <b>Shock</b>                                    | 150 m/s <sup>2</sup> (15g), 11 ms semi-sinusoidal wave to IEC 60068-2-27  |
| <b>Service conditions</b>                       |   |
| <b>Mounting position</b>                        | horizontal, stackable   |
| <b>Degree of contamination</b>                  | II to IEC 60664-3   |
| <b>Admissible operating environment</b>         | operation restricted to environments complying with IP54 or better to IEC 60529 (e.g. suitable control cabinet)   |
| <b>Operating temperature</b>                    | 0 °C ... + 55 °C  |

|                              |   |
|------------------------------|---|
| Rel. humidity                | 5% ... 95%, non-condensing  |
| Atmospheric pressure         | 80 kPa to 108 kPa / 0 to 2000 m above msl   |
| Vibration                    | 5 Hz to 8.4 Hz: +/- 3.5 mm amplitude, 8.4 Hz to 150 Hz: 10 m/s <sup>2</sup> (1g), to IEC 60068-2-6, Fc test |
| Shock                        | 150 m/s <sup>2</sup> (15g), 11 ms semi-sinusoidal wave to IEC 60068-2-27                                    |
| <b>Mechanical properties</b> |   |
| Installation                 | 35 mm DIN Mounting rail   |
| Dimensions                   | 25 mm x 120 mm x 90 mm (W x H x D)  |
| Weight                       | approx. 140 gram (without packaging)  |
| Ingress protection           | IP20 <sup>1</sup>   |
| Housing mount                | aluminium   |
| Shield                       | connects straight to module housing   |

|   |  |
|---|--|
|  | <b>Note, information</b>   |
|   | <i>Install and operate the Safety IO at max. 2000 m above msl.</i> |

## 4.5.2 Safe Digital Inputs

| Safe Digital Inputs                               |  |
|---|--|
| Quantity and type                                 | Kuhnke FIO Safety SDI16 SDO4 0.5A and Kuhnke FIO Safety SDI16: 16x single-channel or 8x two-channel, (EN 61131-2, Type 3)<br><br>Kuhnke FIO Safety SDI8 SDO2 0.5A: 8x single-channel or 4x two-channel, (EN 61131-2, Type 3) |
| Diagnosis   | cross-fault, external power supply   |
| Highest safety level (depending on configuration) | <b>Single-channel use:</b><br>Cat. 2/PL d to EN ISO 13849-1, SIL2 to EN 62061 / IEC 61508<br><b>Two-channel use:</b><br>Cat. 4/PL d to EN ISO 13849-1, SIL3 to EN 62061 / IEC 61508  |
| Rising delay / filter time                        | 1 ms + configurable filter time of external sensors (0.5 ms to 1.5 ms) or<br>1 ms + test pulse length of test pulse outputs (1.5 ms)   |
| Sensor type                                       | use of sensors with OSSD outputs to EN 61496, contact-type sensors   |
| Electrical insulation                             | channel/channel: no      channel/E-bus: 500 V <sub>eff</sub>   |
| Signal level                                      | (EN 61131-2, Type 3)<br>Off:    -3 ... 5 V      I <sub>Lmin</sub> = not specified, I <sub>Lmax</sub> = 15 mA.<br>On:    11 V ... 30 V    I <sub>Hmax</sub> = 15 mA, I <sub>Hmin</sub> = 2 mA                                 |
| Maximum voltage                                   | 33 V (max. voltage to input even in case of error)   |
| Signal indication                                 | green LED located next to the terminal   |
| Safe response time                                | < 5 ms; see section "Response Time"  |
| Input current                                     | typ. 3.3 mA (24 V and 24 °C)   |
| Input resistance                                  | typ. 7.3 kΩ  |
| Input capacitance                                 | typ. 100 nF  |

<sup>1</sup> self-declaration, not UL approved

|                            |  |
|----------------------------|--|
| <b>Maximum line length</b> | 100 m (between sensors / module terminals) |
|----------------------------|--|

### 4.5.3 Digital Test Pulse Outputs

| Digital Test Pulse Outputs    |  |
|-------------------------------|--|
| <b>Quantity and type</b>      | Kuhnke FIO Safety SDI16 SDO4 0.5A and Kuhnke FIO Safety SDI16:8x1<br>Kuhnke FIO Safety SDI8 SDO2 0.5A:4x |
| <b>Nominal output current</b> | 50 mA, short-circuit-proof   |
| <b>Signal indication</b>      | LED located next to the terminal (input error LED only)  |
| <b>Switching voltage</b>      | 24 VDC -15% / +20%   |
| <b>Electric strength</b>      | 33 V (max. voltage to output even in case of error)  |
| <b>Test pulse length</b>      | 1500 $\mu$ s, phase-shifted to each channel  |
| <b>Maximum line length</b>    | 100 m (between sensor / module terminals)  |

### 4.5.4 Safe Digital Outputs

| Safe Digital Outputs                                     |  |
|--|--|
| <b>Quantity and type</b>                                 | Kuhnke FIO Safety SDI16 SDO4 0.5A<br>4x semiconductor, 0.5 A, 24 VDC, tolerance to EN 61131-2<br>Kuhnke FIO Safety SDI8 SDO2 0.5A:<br>2x semiconductor, 0.5 A, 24 VDC, tolerance to EN 61131-2<br>Kuhnke FIO Safety SDI16:<br>No outputs |
| <b>Max. safety levels</b>                                | Cat. 4/PL e to EN ISO 13849-1,<br>SIL3 to EN 62061,<br>SIL3 to IEC 61508   |
| <b>Diagnosis</b>   | cross-fault, external power supply   |
| <b>Signal indication</b>                                 | green LED located next to terminal SOX, controlled by CPU  |
| <b>Minimum output current</b>                            | 2 mA, see $\rightarrow$ 6.3.9 Actuator Connection for details  |
| <b>Maximum output current</b>                            | 0.5 A, short-circuit-proof, comply with total load and derating<br>See section $\rightarrow$ 6.3.9 Actuator Connection - Derating of Total Load for details  |
| <b>Maximum output switching frequency</b>                | 2,5 Hz   |
| <b>Capacitive load</b>                                   | yes, see section $\rightarrow$ 6.3.9 Actuator Connection for details<br>Switching of capacity loads  |
| <b>Braking voltage while turning off inductive loads</b> | typ. 40 VDC  |
| <b>Inductive load</b>                                    | yes, see section $\rightarrow$ 6.3.9 Actuator Connection for details<br>Switching of inductive loads up to 2.5 Hz  |
| <b>Maximum line length</b>                               | 100 m (between sensor / module terminals)  |
| <b>Response threshold of output overload protection</b>  | typ. 1.6 A   |
| <b>Output current module<sub>max</sub></b>               | Kuhnke FIO Safety SDI16 SDO4 0.5A: 2 A, comply with derating<br>See section $\rightarrow$ 6.3.9 Actuator Connection - Derating of Total Load for details<br><br>Kuhnke FIO Safety SDI8 SDO2 0.5A:1 A                                     |
| <b>Load resistance range (at nominal voltage)</b>        | 48 $\Omega$ ... 12 k $\Omega$  |

|                              |   |
|------------------------------|---|
| <b>Electrical insulation</b> | channel/channel: no channel/E-bus: 500 V <sub>eff</sub> |
| <b>Approved actuators</b>    | DC13 to EN60947-5-1 Table 4<br>DC1 to EN60947-4         |
| <b>Test pulse length</b>     | configurable: 500 μs ... 1500 μs (configurable)         |
| <b>Supply voltage</b>        | 24 VDC -15% / +20%                                      |
| <b>Electric strength</b>     | 33 V (max. voltage to output even in case of error)     |
| <b>Maximum line length</b>   | 100 m (between actuator / module terminals)             |

## 4.6 Safety-related Ratings of a Single-channel Application

The table below lists the safety-related ratings of a single-channel safety function that uses one input and/or output of the safe I/O module.

Note: All components involved in the safety function must be taken into account in order to assess whether the desired safety level is achieved.

| Safety-related ratings of a single-channel application  |   |                                  |                                   |                                    |
|---|---|----------------------------------|-----------------------------------|------------------------------------|
| Highest safety integrity level to EN 62061  | SIL2  |                                  |                                   |                                    |
| Highest safety integrity level to IEC 61508   | SIL2  |                                  |                                   |                                    |
| Highest performance level to EN ISO 13849-1   | Cat. 2/PL d   |                                  |                                   |                                    |
| Hardware fault tolerance (HFT) in single-channel application (IEC 61508)                          | 0<br>(a fault of the application may cause the safeguard to fail) |                                  |                                   |                                    |
| Safety-related ratings of a single-channel application  |   |                                  |                                   |                                    |
| Safety-related ratings  | Ambient module temperature  | 1x input (up to fieldbus)        | Logic circuitry                   | 1x output (from fieldbus)          |
| Probability of failure on demand (PFD <sub>avg</sub> ), proof test interval: 20 years (IEC 61508) | 25 °C   | $7.5 \cdot 10^{-7}$              | $4.01 \cdot 10^{-6}$              | $1.27 \cdot 10^{-8}$               |
|   | 55 °C   | $2.92 \cdot 10^{-6}$             | $9.00 \cdot 10^{-6}$              | $4.09 \cdot 10^{-8}$               |
| Probability of failure per hour (PFH), proof test interval: 20 years (IEC 61508:)                 | 25 °C   | $8.56 \cdot 10^{-11}$ 1/h        | $4.58 \cdot 10^{-10}$ 1/h         | $1.45 \cdot 10^{-12}$ 1/h          |
|   | 55 °C   | $3.33 \cdot 10^{-10}$ 1/h        | $1.03 \cdot 10^{-9}$ 1/h          | $4.66 \cdot 10^{-12}$ 1/h          |
| DC (diagnostic coverage) to EN ISO 13849-1  | 25 °C   | 99 %                             | 98.14 %                           | 99 %                               |
|   | 55 °C   | 99 %                             | 97.38 %                           | 99 %                               |
| Safe failure fraction (SFF)   | 25 °C   | 99.83 %                          | 99.04 %                           | 99.68 %                            |
|   | 55 °C   | 99.79 %                          | 98.95 %                           | 99.68 %                            |
| MTTF d (Mean Time To Failure dangerous) to EN ISO 13849-1   | 25 °C   | 100 years (mathem.: 13341 years) | 100 years (calculated: 226 years) | 100 years (calculated: 9110 years) |
|   | 55 °C   | 100 years (mathem.: 3425 years)  | 100 years (calculated: 197 years) | 100 years (calculated: 2982 years) |

The safety-related ratings are calculated by combining the values of inputs, logic circuitry and outputs to describe their interdependency with the safety function. The rule is to combine the logic circuitry with the relevant number of inputs or outputs once per safe I/O module.

#### Example of single-channel safety functions:

- 1x logic circuitry & 1x input = safety rating of the module from the input to the fieldbus.
- 1x logic circuitry & 1x output = safety rating of the module from the fieldbus to the output.
- 1x input & 1x logic circuitry & 1x output = safety rating of input + output

## 4.7 Safety-related Ratings of a Two-channel Application

The table below lists the safety-related ratings of a two-channel safety function that uses two inputs (pair of inputs) and/or two outputs (pair of outputs) of the safe I/O module.

Note: All components involved in the safety function must be taken into account in order to assess whether the desired safety level is achieved.

| Safety-related ratings of a two-channel application   |  |                                  |                                   |                                    |
|---|--|----------------------------------|-----------------------------------|------------------------------------|
| Highest safety integrity level to EN 62061  | SIL3   |                                  |                                   |                                    |
| Highest safety integrity level to IEC 61508   | SIL3   |                                  |                                   |                                    |
| Highest performance level to EN ISO 13849-1   | Cat. 4/PL e  |                                  |                                   |                                    |
| Hardware fault tolerance (HFT) in single-channel application (IEC 61508)                          | 1<br>(a fault of the application need not cause the safeguard to fail) |                                  |                                   |                                    |
| Safety-related ratings of a two-channel application   |  |                                  |                                   |                                    |
| Safety-related ratings  | Ambient module temperature   | Pair of inputs (up to fieldbus)  | Logic circuitry                   | Pair of outputs (from fieldbus)    |
| Probability of failure on demand (PFD <sub>avg</sub> ), proof test interval: 20 years (IEC 61508) | 25 °C  | $7.51 \cdot 10^{-9}$             | $4.01 \cdot 10^{-6}$              | $1.27 \cdot 10^{-8}$               |
|   | 55 °C  | $2.94 \cdot 10^{-8}$             | $9.00 \cdot 10^{-6}$              | $4.09 \cdot 10^{-8}$               |
| Probability of failure per hour (PFH), proof test interval: 20 years (IEC 61508)                  | 25 °C  | $8.57 \cdot 10^{-13}$ 1/h        | $4.58 \cdot 10^{-10}$ 1/h         | $1.45 \cdot 10^{-121}$ 1/h         |
|   | 55 °C  | $3.35 \cdot 10^{-12}$ 1/h        | $1.03 \cdot 10^{-9}$ 1/h          | $4.66 \cdot 10^{-12}$ 1/h          |
| DC (diagnostic coverage) to EN ISO 13849-1  | 25 °C  | 99.00 %                          | 98.14 %                           | 99.00 %                            |
|   | 55 °C  | 99.00 %                          | 97.38 %                           | 99.00 %                            |
| Safe failure fraction (SFF)   | 25 °C  | 99.83 %                          | 99.04 %                           | 99.68 %                            |
|   | 55 °C  | 99.79 %                          | 98.95 %                           | 99.68 %                            |
| MTTF d (Mean Time To Failure dangerous) to EN ISO 13849-1   | 25 °C  | 100 years (mathem.: 13341 years) | 100 years (calculated: 226 years) | 100 years (calculated: 9110 years) |
|   | 55 °C  | 100 years (mathem.: 3425 years)  | 100 years (calculated: 197 years) | 100 years (calculated: 2982 years) |

The safety-related ratings are calculated by combining the values of inputs, logic circuitry and outputs to describe their interdependency with the safety function. The rule is to combine the logic circuitry with the relevant number of inputs or outputs once per safe I/O module.

**Examples of two-channel safety functions:**

- 1x logic circuitry & 1x pair of inputs = safety rating of the module from the pair of inputs to the fieldbus.
- 1x logic circuitry & 1x pair of outputs = safety rating of the module from the fieldbus to the pair of outputs.
- 1x pair of inputs & 1x logic circuitry & 1x pair of outputs = safety rating of pairs of inputs + outputs

## 4.8 Response Time

In a safety system, the total reaction time typically consists of the following partial reaction times:

- signal processing by sensor
- signal processing by the Kuhnke FIO Safety I/O module
- time of input data transfer across the EtherCAT bus between the Kuhnke FIO Safety I/O module and the safe PLC
- safe PLC program runtime
- time of output data transfer across the EtherCAT bus between the Kuhnke FIO Safety PLC and the Kuhnke FIO Safety I/O module
- signal processing by the Kuhnke FIO Safety I/O module
- signal processing by actuator

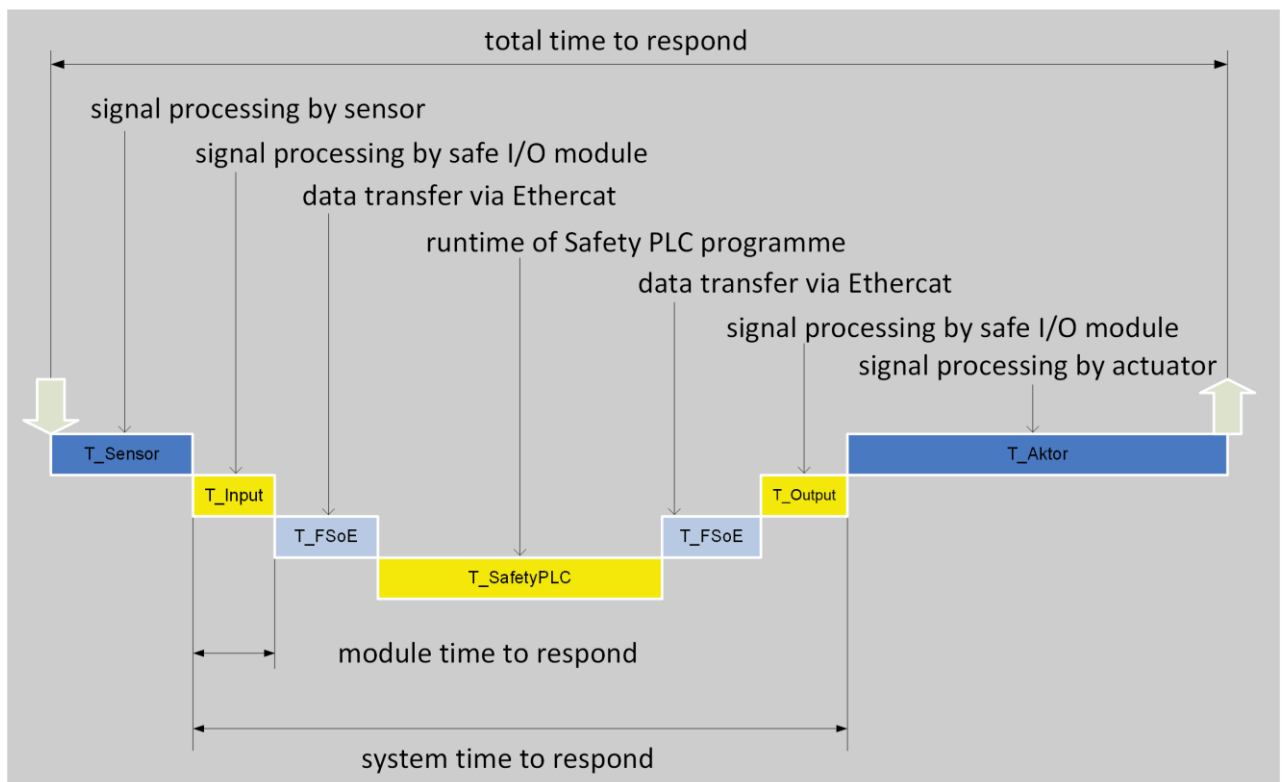

|   |  |
|---|--|
|  | <b>CAUTION</b>   |
|   | <p><i>To calculate the safe response time, take account of the fieldbus runtimes and the Safety PLC's cycle time.</i></p> <p><i>Avoid personal injury and damage to property</i></p> <p>The fieldbus runtimes and the Safety PLC's cycle time must be taken account of to rate and calculate the safe response time.</p> |

As a general rule, a safe response time of max. **5 ms** may be assumed for the safe I/O module. This time ensures that the input and output signals will change and a safe state will be achieved. Remember to consider the filter time because it influences the I/O module's maximum response time. An inalterable filter time of 1 ms is set for the inputs. This is supplemented by a configurable input filter for external sensors (adjustable between 0.5 ms and 1.5 ms). A 1.5 ms filter time is preset for using the module's own test pulse outputs.

**Examples:**

Using **external sensors:**

Configurable input filter set to: 1.2 ms

Inalterable internal filter time: 1 ms

Total filter time: 2.2 ms

Using the **module's own test pulse:**

Preset input filter time: 1.5 ms

Inalterable internal filter time: 1 ms

Total filter time: 2.5 ms

The safe response time of digital inputs defines as the maximum time it takes before the FSoE frame is available on the EtherCAT bus after the signal of an input changes.

The safe response time of digital outputs defines as the maximum time it takes until the signal of a digital output changes after the EtherCAT module has received a FSoE frame.

Even if a fault occurs will the module be in a safe state before the safe response time is over. The following failure sources will provoke a change to the safe state:

- Faults detected at the module inputs
- Faults detected at the module outputs
- Internal module faults (self-diagnosis)



**CAUTION**

***Safety function pressure-sensitive mat requires a response time of 25 ms***

*Avoid personal injury and damage to property*

The pressure-sensitive mat function achieves a set response time of 25 ms between a change in mat state and providing the information on the EtherCAT bus.

### 4.9 Dimensions

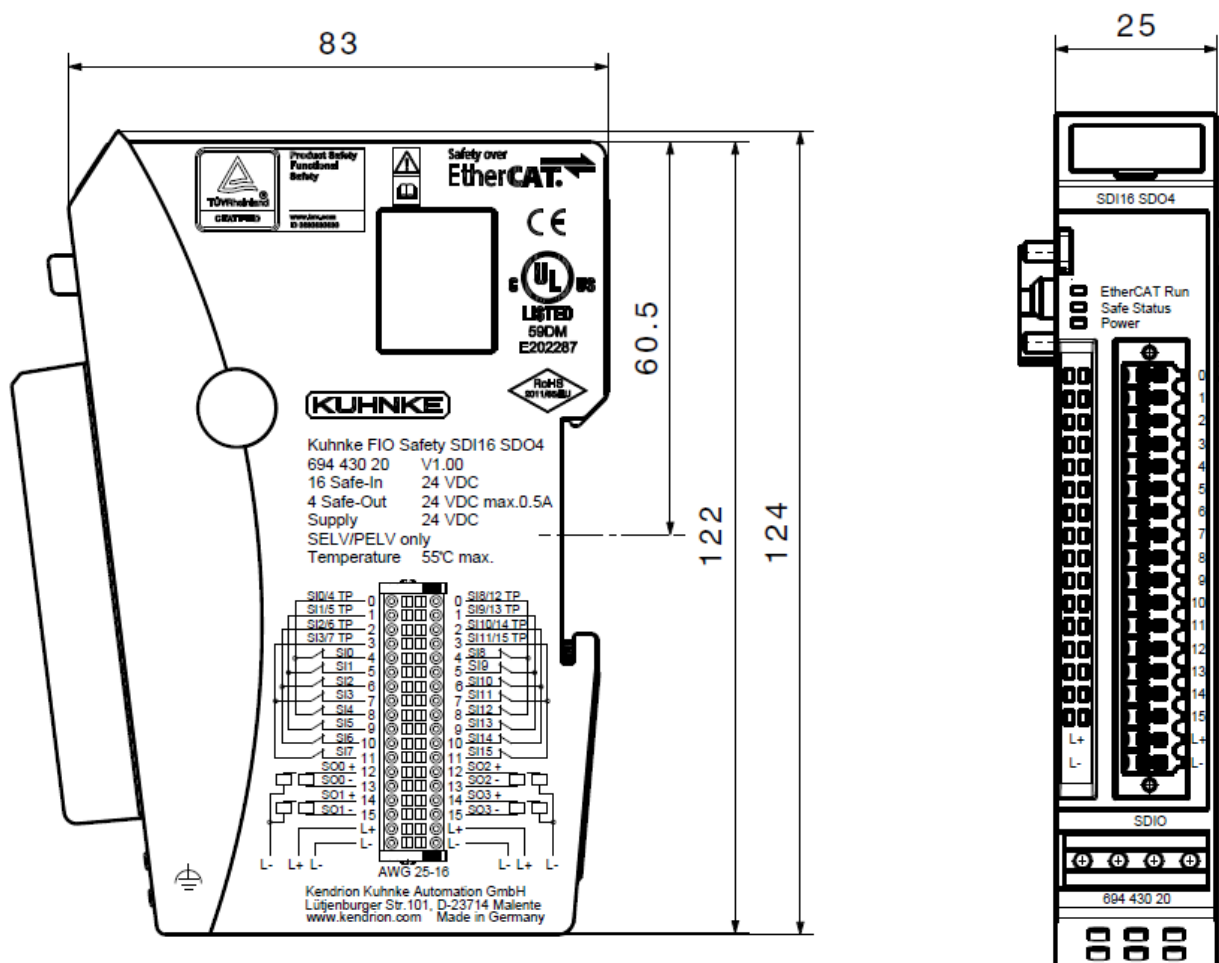

### 4.10 Transport and Storage

At times of transport and storage, protect Kuhnke FIO Safety I/O against inadmissible exposure such as mechanical stress, temperature, humidity and/or aggressive atmospheres. Transport and store Kuhnke FIO Safety I/O in its original packaging if possible.

Verify that the contacts are neither soiled nor damaged when consigning the unit to stock or re-packaging it. Keep and transport Kuhnke FIO Safety I/O in a container/packaging ensuring electrostatic discharge (ESD) compliance. Some parts of the units are sensitive to ESD and may be damaged if handled inappropriately. Thus, best transport practice is to place open assemblies in statically shielded transport bags with a metal coating which avoid contamination by amines, amides or silicone. When putting Kuhnke FIO Safety I/O into service and performing any maintenance, you should also take the appropriate precautions against electrostatic discharge.

|   |  |
|---|--|
|  | <p><b>CAUTION</b></p>  |
|   | <p><b>Electrostatic discharge</b><br/> <i>Destruction of or damage to the unit.</i></p> <ul style="list-style-type: none"> <li>• Transport and store FIO Safety I/O in its original packaging.</li> <li>• Ensure that the ambient conditions are as specified at all times during transport and storage.</li> <li>• Handle FIO Safety I/O in a well-earthed environment (persons, place of work, packaging).</li> <li>• Do not touch electrically conductive parts such as data contacts. Some of the electronic components may be destroyed if exposed to electrostatic discharge.</li> </ul> |



# 5 Construction and Functionality

## 5.1 Labelling and Identification

### 5.1.1 Imprinted Texts and Symbols

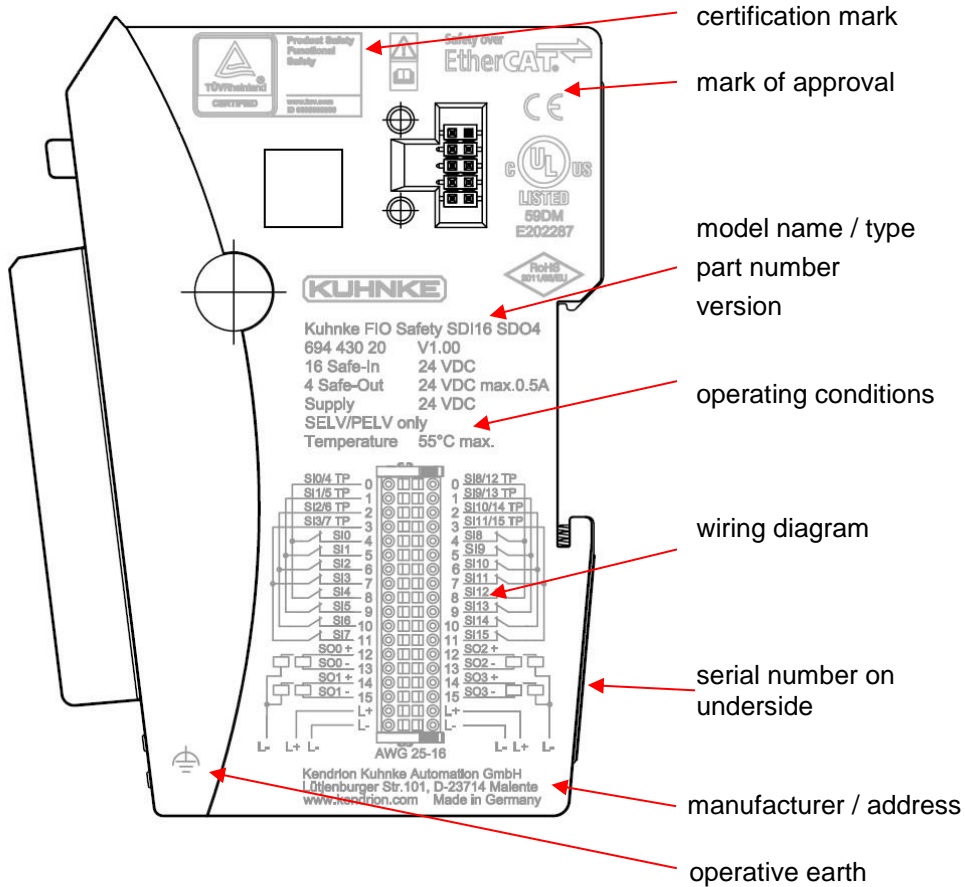

### 5.1.2 Serial Number

A label showing the serial number is affixed to the aluminium mount on the back of the module. The numerical code incorporates the production date and a serial number. Kendrion Kuhnke can use the numerical code to distinctly identify the model, software and hardware release date. It is a means of traceability.

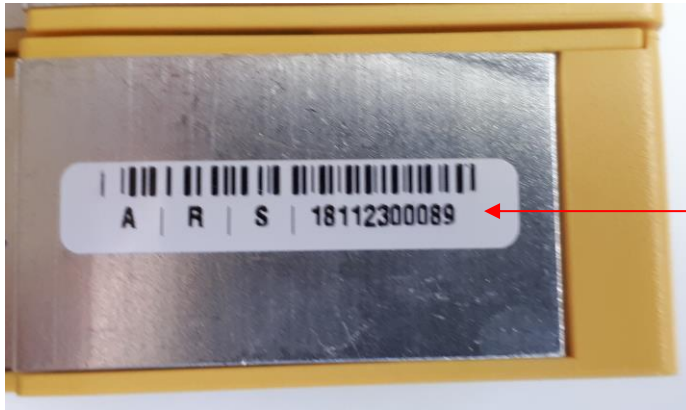

Serial Number

#### Make-up of serial number

YY MM DD NNNNN

Example:

The unit shown above was manufactured on 23rd November 2018 and has the serial number 00089.

18 11 23 00089

five-digit number of nth unit built on that day

production date as year month day

The serial number is also stored in object 1018 sub-index 4 and can be retrieved by SDO Transfer → 8.1.7 Identity Object 1018h.

### 5.2 Contents of Package

The FIO Safety I/O package contains:

- FIO Safety I/O
- Module bus cover
- Connector

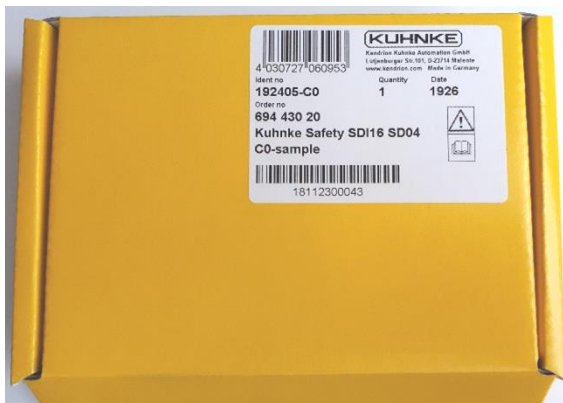

## 5.3 Connectors

### 5.3.1 E-bus and Module Lock

The system plugs and the module lock are located on the sides of Safety I/O. These contact pins interconnect the modules. They supply power to the module's electronic circuitry and transfer the EtherCAT signals. Verify that the end cap from the package is in place to protect the module bus connector on the last module at the right-hand side of a terminal unit against dirt.

The integrated module lock prevents the modules from coming apart under mechanical load or vibration.

|   |  |
|---|--|
|  | <b>CAUTION</b>   |
|   | <p><b><i>Interconnecting units of different design</i></b><br/> <i>Damage to the unit's mechanical elements</i><br/>           Use approved modules in a FIO network only.</p> |

### 5.3.2 Combi Plug X1

|   |  |
|---|--|
|  | <b>Note, information</b>   |
|   | <p><i>Only use the connector (spring-assisted or push-in) from the package to connect a unit to the Kuhnke FIO Safety I/O module. Refer to section → 6.3 Electrical Installation further down below for details on how to connect sensors and actuators.</i></p> |

|   |   |
|---|---|
|  | <b>CAUTION</b>  |
|   | <p><b><i>Safe function jeopardised by cross-faults</i></b><br/> <i>Improper installation may cause malfunctions due to cross-faults at the contacts</i><br/>           By design and if installed correctly, the connector prevents cross-faults at the contacts. Ensure a correct and technically perfect installation because cross-faults or shorts may jeopardise the module's safe function.</p> |

### 5.3.3 Kuhnke FIO Safety SDI16 SDO4

The combi plug is located at the front of FIO Safety I/O. The sensors and actuators and the module's power supply all attach to this connector.

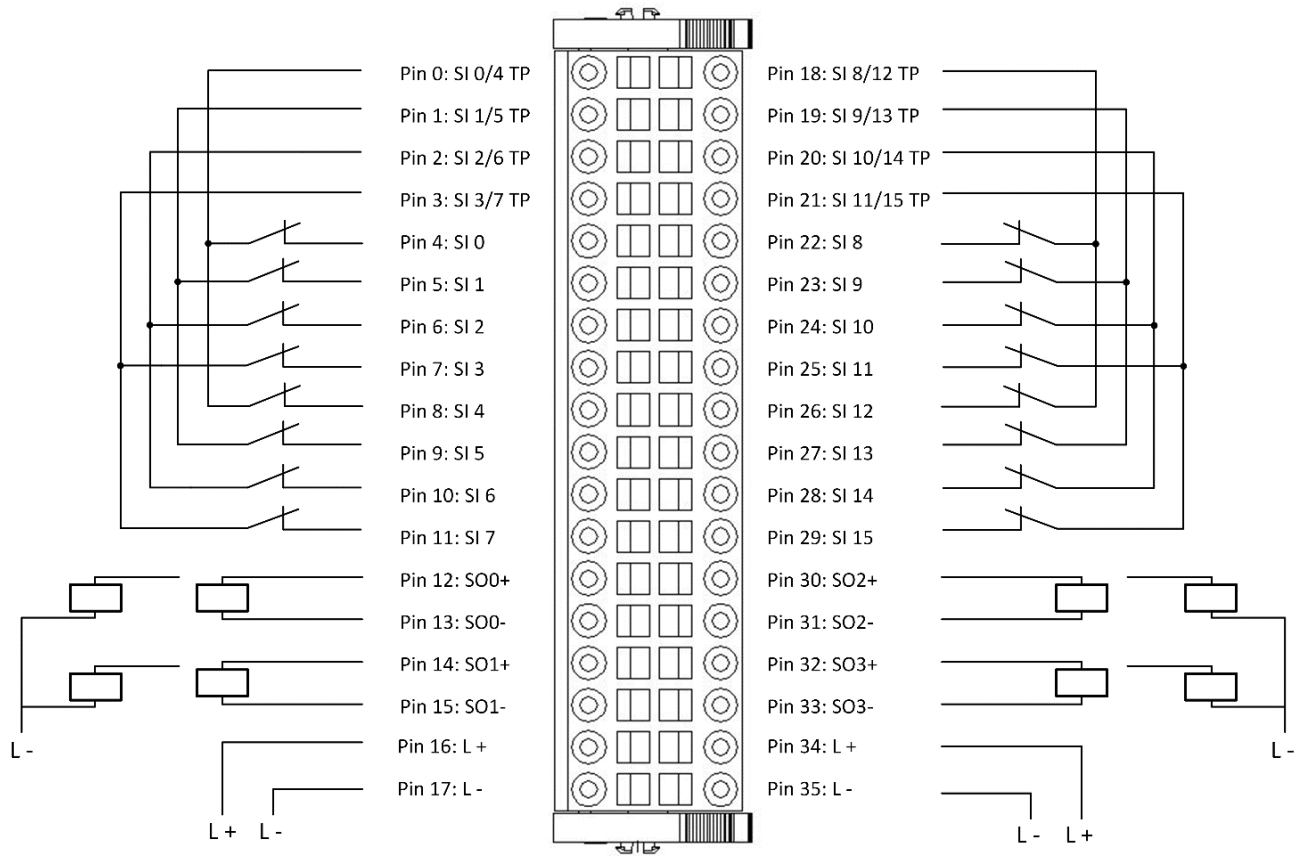

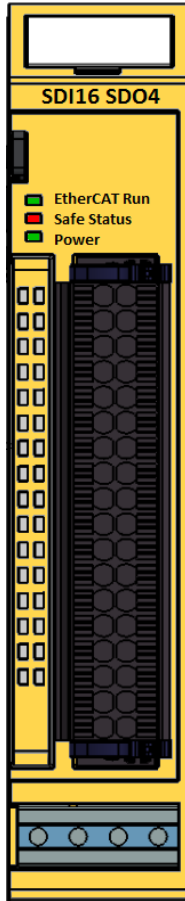

| Connector X1 |                                    |             |
|--------------|------------------------------------|-------------|
| Pin          | Function                           | Signal      |
| 0            | Test pulse output Safe-In 0/4 TP   | SI 0/4 TP   |
| 1            | Test pulse output Safe-In 1/5 TP   | SI 1/5 TP   |
| 2            | Test pulse output Safe-In 2/6 TP   | SI 2/6 TP   |
| 3            | Test pulse output Safe-In 3/7 TP   | SI 3/7 TP   |
| 4            | Safe input Safe-In 0               | SI 0        |
| 5            | Safe input Safe-In 1               | SI 1        |
| 6            | Safe input Safe-In 2               | SI 2        |
| 7            | Safe input Safe-In 3               | SI 3        |
| 8            | Safe input Safe-In 4               | SI 4        |
| 9            | Safe input Safe-In 5               | SI 5        |
| 10           | Safe input Safe-In 6               | SI 6        |
| 11           | Safe input Safe-In 7               | SI 7        |
| 12           | Safe output Safe-Out 0 +           | SO0 +       |
| 13           | Safe output Safe-Out 0 -           | SO0 -       |
| 14           | Safe output Safe-Out 1 +           | SO1 +       |
| 15           | Safe output Safe-Out 1 -           | SO1 -       |
| 16           | 24 V supply to the outputs         | L+          |
| 17           | GND                                | L-          |
| 18           | Test pulse output Safe-In 8/12 TP  | SI 8/12 TP  |
| 19           | Test pulse output Safe-In 9/13 TP  | SI 9/13 TP  |
| 20           | Test pulse output Safe-In 10/14 TP | SI 10/14 TP |
| 21           | Test pulse output Safe-In 11/15 TP | SI 11/15 TP |
| 22           | Safe input Safe-In 8               | SI 8        |
| 23           | Safe input Safe-In 9               | SI 9        |
| 24           | Safe input Safe-In 10              | SI 10       |
| 25           | Safe input Safe-In 11              | SI 11       |
| 26           | Safe input Safe-In 12              | SI 12       |
| 27           | Safe input Safe-In 13              | SI 13       |
| 28           | Safe input Safe-In 14              | SI 14       |
| 29           | Safe input Safe-In 15              | SI 15       |
| 30           | Safe output Safe-Out 2 +           | SO2 +       |
| 31           | Safe output Safe-Out 2 -           | SO2 -       |
| 32           | Safe output Safe-Out 3 +           | SO3 +       |
| 33           | Safe output Safe-Out 3 -           | SO3 -       |
| 34           | 24 V supply to the outputs         | L+          |
| 35           | GND                                | L-          |

### 5.3.4 Kuhnke FIO Safety SDI16

The combi plug is located at the front of FIO Safety I/O. The sensors and actuators and the module's power supply all attach to this connector.

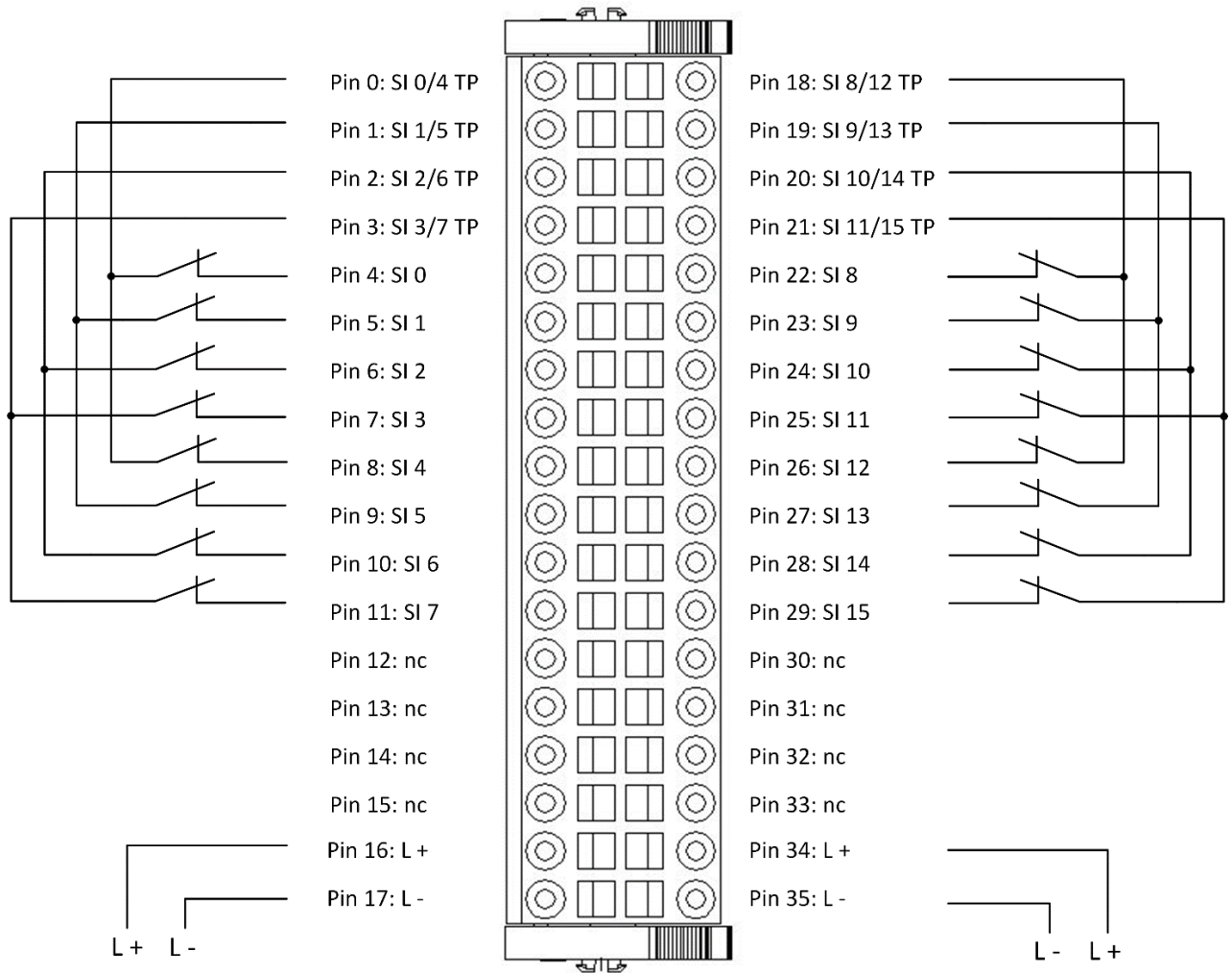

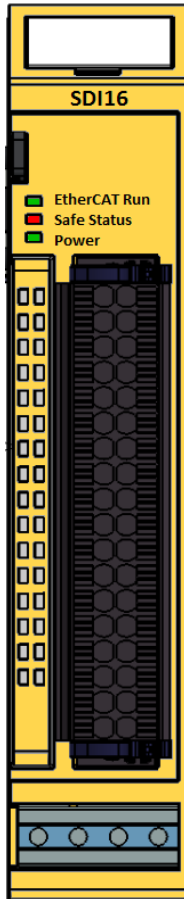

| Connector X1 |                                    |             |
|--------------|------------------------------------|-------------|
| Pin          | Function                           | Signal      |
| 0            | Test pulse output Safe-In 0/4 TP   | SI 0/4 TP   |
| 1            | Test pulse output Safe-In 1/5 TP   | SI 1/5 TP   |
| 2            | Test pulse output Safe-In 2/6 TP   | SI 2/6 TP   |
| 3            | Test pulse output Safe-In 3/7 TP   | SI 3/7 TP   |
| 4            | Safe input Safe-In 0               | SI 0        |
| 5            | Safe input Safe-In 1               | SI 1        |
| 6            | Safe input Safe-In 2               | SI 2        |
| 7            | Safe input Safe-In 3               | SI 3        |
| 8            | Safe input Safe-In 4               | SI 4        |
| 9            | Safe input Safe-In 5               | SI 5        |
| 10           | Safe input Safe-In 6               | SI 6        |
| 11           | Safe input Safe-In 7               | SI 7        |
| 12           | - Do not connect -                 | nc          |
| 13           | - Do not connect -                 | nc          |
| 14           | - Do not connect -                 | nc          |
| 15           | - Do not connect -                 | nc          |
| 16           | 24 V supply to the outputs         | L+          |
| 17           | GND                                | L-          |
| 18           | Test pulse output Safe-In 8/12 TP  | SI 8/12 TP  |
| 19           | Test pulse output Safe-In 9/13 TP  | SI 9/13 TP  |
| 20           | Test pulse output Safe-In 10/14 TP | SI 10/14 TP |
| 21           | Test pulse output Safe-In 11/15 TP | SI 11/15 TP |
| 22           | Safe input Safe-In 8               | SI 8        |
| 23           | Safe input Safe-In 9               | SI 9        |
| 24           | Safe input Safe-In 10              | SI 10       |
| 25           | Safe input Safe-In 11              | SI 11       |
| 26           | Safe input Safe-In 12              | SI 12       |
| 27           | Safe input Safe-In 13              | SI 13       |
| 28           | Safe input Safe-In 14              | SI 14       |
| 29           | Safe input Safe-In 15              | SI 15       |
| 30           | - Do not connect -                 | nc          |
| 31           | - Do not connect -                 | nc          |
| 32           | - Do not connect -                 | nc          |
| 33           | - Do not connect -                 | nc          |
| 34           | 24 V supply to the outputs         | L+          |
| 35           | GND                                | L-          |

### 5.3.5 Kuhnke FIO Safety SDI8 SDO2

The spring-assisted combi plug is located at the front of FIO Safety I/O. The sensors and actuators and the module's power supply all attach to this connector.

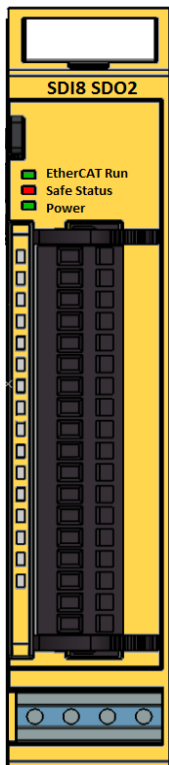
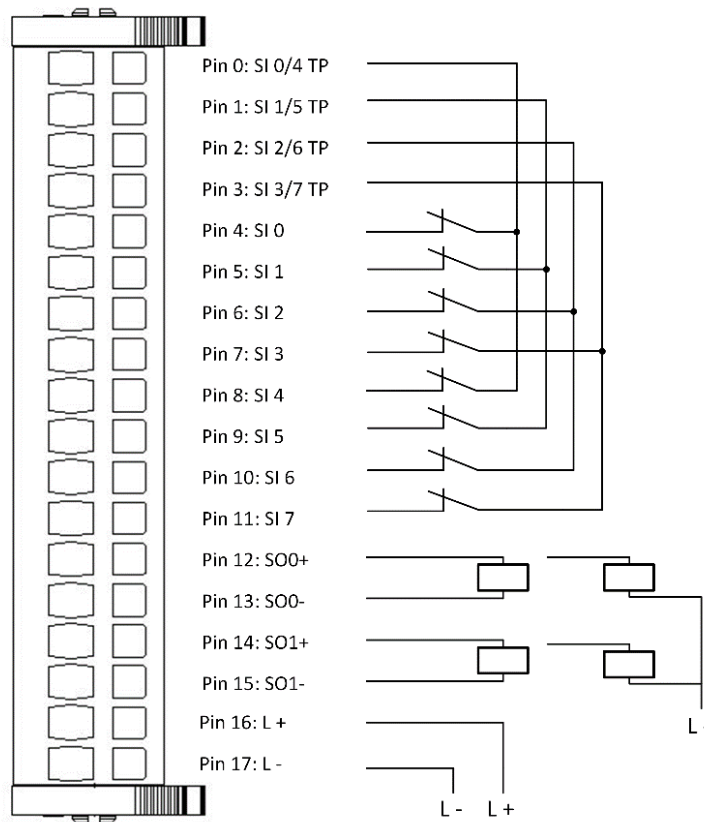

| Connector X1 |                                  |           |
|--------------|----------------------------------|-----------|
| Pin          | Function                         | Signal    |
| 0            | Test pulse output Safe-In 0/4 TP | SI 0/4 TP |
| 1            | Test pulse output Safe-In 1/5 TP | SI 1/5 TP |
| 2            | Test pulse output Safe-In 2/6 TP | SI 2/6 TP |
| 3            | Test pulse output Safe-In 3/7 TP | SI 3/7 TP |
| 4            | Safe input Safe-In 0             | SI 0      |
| 5            | Safe input Safe-In 1             | SI 1      |
| 6            | Safe input Safe-In 2             | SI 2      |
| 7            | Safe input Safe-In 3             | SI 3      |
| 8            | Safe input Safe-In 4             | SI 4      |
| 9            | Safe input Safe-In 5             | SI 5      |
| 10           | Safe input Safe-In 6             | SI 6      |
| 11           | Safe input Safe-In 7             | SI 7      |
| 12           | Safe output Safe-Out 0 +         | SO0 +     |
| 13           | Safe output Safe-Out 0 -         | SO0 -     |
| 14           | Safe output Safe-Out 1 +         | SO1 +     |
| 15           | Safe output Safe-Out 1 -         | SO1 -     |
| 16           | 24 V supply to the outputs       | L+        |
| 17           | GND                              | L-        |



### 5.3.6 Wiring Example

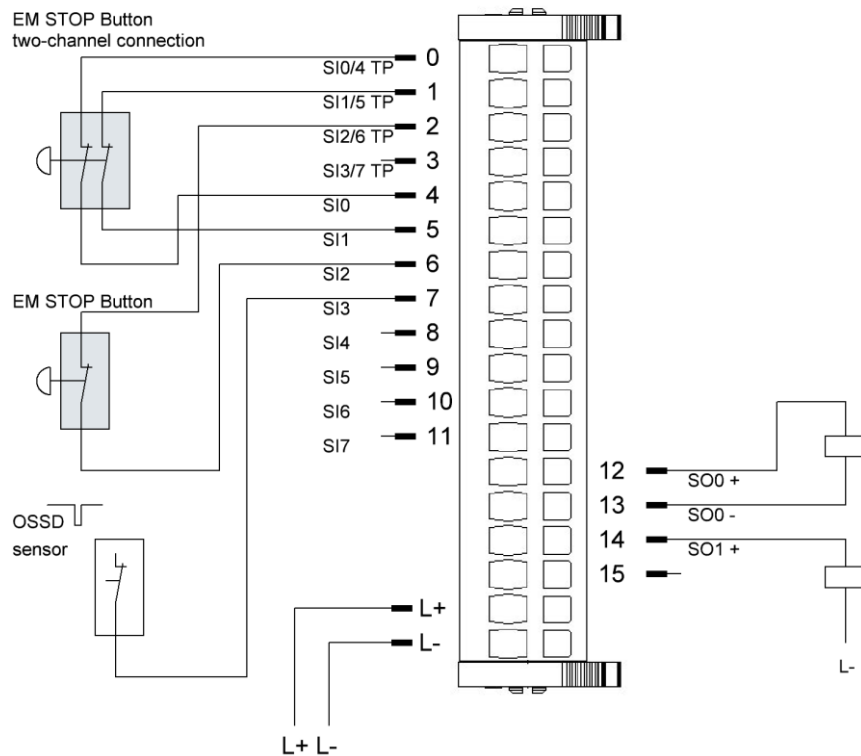

**Figure 2: Example of how to wire the inputs and outputs**

The Kuhnke FIO Safety I/O module is intended to provide functional safety to industrial automation and to protect humans and machines in conformity with Machinery Directive 2006/42/EC.



It therefore supports the connection of many different safety-related sensors.

Examples:

- Single-channel and two-channel contact-type sensors such as EMERGENCY STOP button
- Sensors with single and two-channel OSSD signals such as light grids
- Selector switches, safety mats and connecting blocks

Provided that the admissible maximum installed loads are not exceeded, resistive and inductive loads can be operated at the outputs, see section →

Safe Digital Outputs.

|   |   |
|---|---|
|  | <p><b>Note, information</b></p> <p>Refer to section 7 Connection Examples for examples of how to connect various sensors and actuators.</p>   |
|  | <p><b>CAUTION</b></p> <p><b>Safe function jeopardised by cross-faults</b></p> <p><i>Improper installation may cause malfunctions due to cross-faults at the contacts</i></p> <p>When test pulses are enabled, the Kuhnke FIO Safety I/O module will detect cross-faults between the inputs / outputs and other signal lines of the same module. Note that you must prevent cross-faults with the security functions of other modules. You should therefore protect the signal lines and/or lay them separately.</p> |

## 5.4 Indicators and Controls

### 5.4.1 LED "EtherCAT Run"

LED "EtherCAT Run" indicates the state of EtherCAT communication.

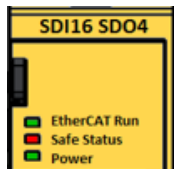

| LED "EtherCAT Run" |         |   |
|--------------------|---------|---|
| LED                | State   | Explanation / State                     |
| Off                | Init    | Initialising, no data exchange          |
| Off/green, 1:1     | Pre-Op  | Pre-operational, no data exchange       |
| Off/green, 5:1     | Safe-Op | Safe operation, inputs readable         |
| Green, on          | Op      | Operational, unrestricted data exchange |

### 5.4.2 LED "Safe Status"

Duo LED safe "status" indicates the state of the module regarding its safety function.



| LED "Safe Status" |       |  |
|-------------------|-------|--|
| LED               | State | Explanation                            |
| Green, on         | OK    | Safety I/O provides safe functionality |
| Red, on           | Error | Safety I/O in fail-safe state          |

### 5.4.3 LED "Power"

LED "Power" indicates the state of the power supply to Kuhnke's FIO Safety I/O module.



| LED "Power" | State | Explanation   |
|-------------|-------|---|
| Off         |       | No power supplied to the module.  |
| Red on      | Error | Wrong power supplied to the module. $\leq 18.5\text{ V}$ or $\geq 29.45\text{ V}$ |
| Green, on   | OK    | Correct voltage of 24 VDC -15% / +20% supplied to the module.                     |



#### Information

Kuhnke's FIO Safety I/O module features a high/low voltage watchdog for the 24 VDC supply voltage.  
Its fail-safe state is enabled at voltages above typ. 29.45 V or below typ. 18.5 V.

### 5.4.4 LEDs "Channel"

The "Channel" LEDs are allocated to the module's terminals. Every group of 2 LEDs indicates the state of the associated functional unit of output and/or input.

#### 5.4.4.1 "Channel" LEDs of Kuhnke FIO Safety SDI16 SDO4

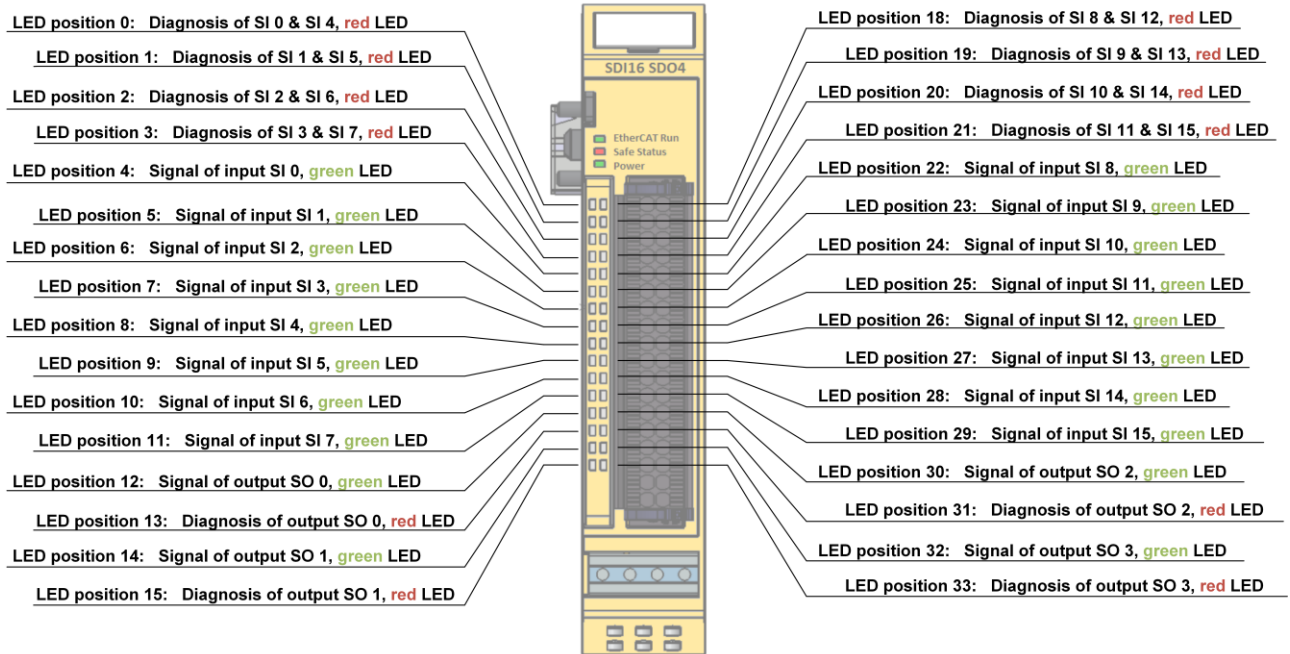

LEDs "Channel"; Safe digital inputs SI 0 .. SI 7

| LED position | Channel            | Function              | LED   | Explanation  |
|--------------|--------------------|-----------------------|-------|--|
| 0            | Inputs SI 0 & SI 4 | SI 0 & SI 4 diagnosis | Off   | Normal operation                                     |
|              |                    |                       | Red   | External power supply or cross-fault at SI 0 or SI 4 |
| 1            | Inputs SI 1 & SI 5 | SI 1 & SI 5 diagnosis | Off   | Normal operation                                     |
|              |                    |                       | Red   | External power supply or cross-fault at SI 1 or SI 5 |
| 2            | Inputs SI 2 & SI 6 | SI 2 & SI 6 diagnosis | Off   | Normal operation                                     |
|              |                    |                       | Red   | External power supply or cross-fault at SI 2 or SI 6 |
| 3            | Inputs SI 3 & SI 7 | SI 3 & SI 7 diagnosis | Off   | Normal operation                                     |
|              |                    |                       | Red   | External power supply or cross-fault at SI 3 or SI 7 |
| 4            | Input SI 0         | SI 0 state            | Off   | No valid input signal on channel 0, logical "0"      |
|              |                    |                       | Green | 24 VDC supplied to channel 0, logical "1"            |
| 5            | Input SI 1         | SI 1 state            | Off   | No valid input signal on channel 1, logical "0"      |
|              |                    |                       | Green | 24 VDC supplied to channel 1, logical "1"            |
| 6            | Input SI 2         | SI 2 state            | Off   | No valid input signal on channel 2, logical "0"      |
|              |                    |                       | Green | 24 VDC supplied to channel 2, logical "1"            |
| 7            | Input SI 3         | SI 3 state            | Off   | No valid input signal on channel 3, logical "0"      |
|              |                    |                       | Green | 24 VDC supplied to channel 3, logical "1"            |
| 8            | Input SI 4         | SI 4 state            | Off   | No valid input signal on channel 4, logical "0"      |
|              |                    |                       | Green | 24 VDC supplied to channel 4, logical "1"            |

|    |                      |                         |       |  |
|----|----------------------|-------------------------|-------|--|
| 9  | Input SI 5           | SI 5 state              | Off   | No valid input signal on channel 5, logical "0"  |
|    |                      |                         | Green | 24 VDC supplied to channel 5, logical "1"        |
| 10 | Input SI 6           | SI 6 state              | Off   | No valid input signal on channel 6, logical "0"  |
|    |                      |                         | Green | 24 VDC supplied to channel 6, logical "1"        |
| 11 | Input SI 7           | SI 7 state              | Off   | No valid input signal on channel 7, logical "0"  |
|    |                      |                         | Green | 24 VDC supplied to channel 7, logical "1"        |
| 18 | Inputs SI 8 & SI 12  | SI 8 & SI 12 diagnosis  | Off   | Normal operation                                 |
|    |                      |                         | Red   | Cross-fault or external power to SI 8 or SI 12   |
| 19 | Inputs SI 9 & SI 13  | SI 9 & SI 13 diagnosis  | Off   | Normal operation                                 |
|    |                      |                         | Red   | Cross-fault or external power to SI 9 or SI 13   |
| 20 | Inputs SI 10 & SI 14 | SI 10 & SI 14 diagnosis | Off   | Normal operation                                 |
|    |                      |                         | Red   | Cross-fault or external power to SI 10 or SI 14  |
| 21 | Inputs SI 11 & SI 15 | SI 11 & SI 15 diagnosis | Off   | Normal operation                                 |
|    |                      |                         | Red   | Cross-fault or external power to SI 11 or SI 15  |
| 22 | Input SI 8           | SI 8 state              | Off   | No valid input signal on channel 8, logical "0"  |
|    |                      |                         | Green | 24 VDC supplied to channel 8, logical "1"        |
| 23 | Input SI 9           | SI 9 state              | Off   | No valid input signal on channel 9, logical "0"  |
|    |                      |                         | Green | 24 VDC supplied to channel 9, logical "1"        |
| 24 | Input SI 10          | SI 10 state             | Off   | No valid input signal on channel 10, logical "0" |
|    |                      |                         | Green | 24 VDC supplied to channel 10, logical "1"       |
| 25 | Input SI 11          | SI 11 state             | Off   | No valid input signal on channel 11, logical "0" |
|    |                      |                         | Green | 24 VDC supplied to channel 11, logical "1"       |
| 26 | Input SI 12          | SI 12 state             | Off   | No valid input signal on channel 12, logical "0" |
|    |                      |                         | Green | 24 VDC supplied to channel 12, logical "1"       |
| 27 | Input SI 13          | SI 13 state             | Off   | No valid input signal on channel 13, logical "0" |
|    |                      |                         | Green | 24 VDC supplied to channel 13, logical "1"       |
| 28 | Input SI 14          | SI 14 state             | Off   | No valid input signal on channel 14, logical "0" |
|    |                      |                         | Green | 24 VDC supplied to channel 14, logical "1"       |
| 29 | Input SI 15          | SI 15 state             | Off   | No valid input signal on channel 15, logical "0" |
|    |                      |                         | Green | 24 VDC supplied to channel 15, logical "1"       |



### Note, information

- The red "diagnosis" LEDs are disabled if the safe digital inputs are used without the safe digital test pulse outputs.
- The green "status" LEDs of the inputs will indicate the presence of a 24 VDC signal at an input even if that input has not been set up in the configuration.

**LEDs "Channel"; Safe digital outputs SO 0 and SO 1**

| LED position | Channel     | Function  | LED   | Explanation                               |
|--------------|-------------|-----------|-------|---|
| 12           | Output SO 0 | Status    | Off   | No output signal at output 0, logical "0" |
|              |             |           | Green | Output signal at output 0, logical "1"    |
| 13           |             | Diagnosis | Off   | Normal operation                          |
|              |             |           | Red   | External power supply or cross-fault      |
| 14           | Output SO 1 | Status    | Off   | No output signal at output 1, logical "0" |
|              |             |           | Green | Output signal at output 1, logical "1"    |
| 15           |             | Diagnosis | Off   | Normal operation                          |
|              |             |           | Red   | External power supply or cross-fault      |
| 30           | Output SO 2 | Status    | Off   | No output signal at output 2, logical "0" |
|              |             |           | Green | Output signal at output 2, logical "1"    |
| 31           |             | Diagnosis | Off   | Normal operation                          |
|              |             |           | Red   | External power supply or cross-fault      |
| 32           | Output SO 3 | Status    | Off   | No output signal at output 3, logical "0" |
|              |             |           | Green | Output signal at output 3, logical "1"    |
| 33           |             | Diagnosis | Off   | Normal operation                          |
|              |             |           | Red   | External power supply or cross-fault      |

5.4.4.2 "Channel" LEDs of Kuhnke FIO Safety SDI16

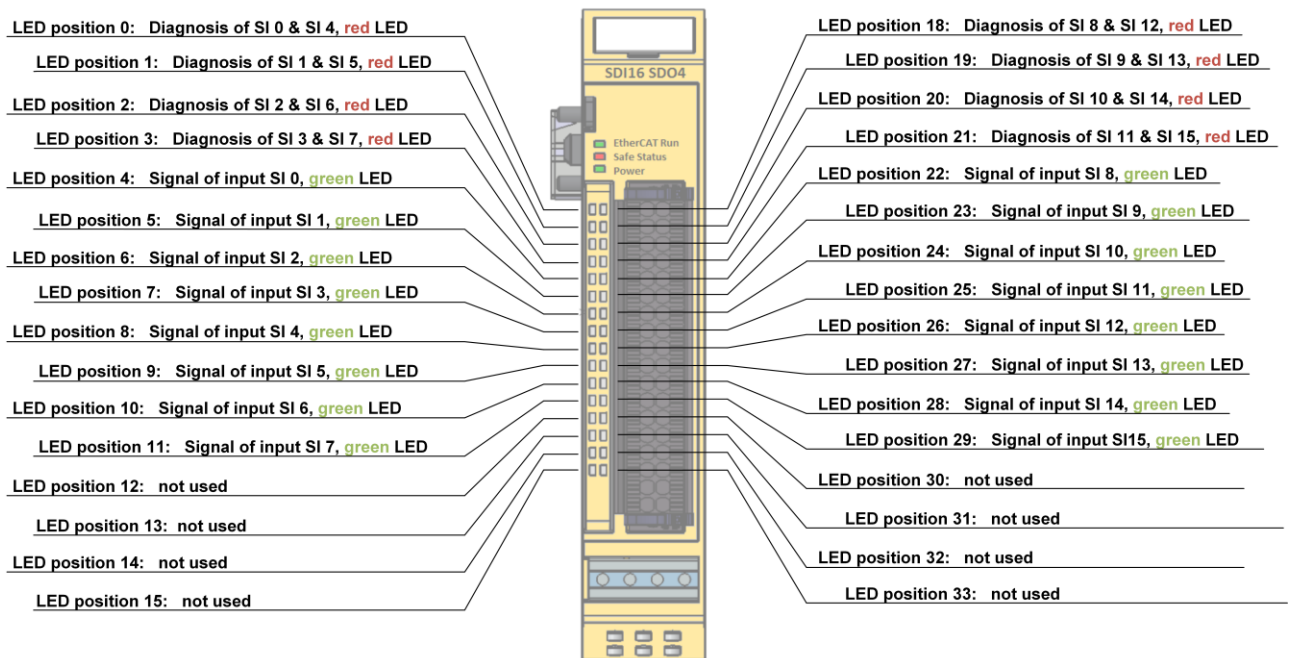

**LEDs "Channel"; Safe digital inputs SI 0 .. SI 7**

| LED position | Channel            | Function              | LED | Explanation  |
|--------------|--------------------|-----------------------|-----|--|
| 0            | Inputs SI 0 & SI 4 | SI 0 & SI 4 diagnosis | Off | Normal operation                                     |
|              |                    |                       | Red | External power supply or cross-fault at SI 0 or SI 4 |
| 1            | Inputs SI 1 & SI 5 | SI 1 & SI 5 diagnosis | Off | Normal operation                                     |
|              |                    |                       | Red | External power supply or cross-fault at SI 1 or SI 5 |

| LEDs "Channel"; Safe digital inputs SI 0 .. SI 7 |                         |                            |       |  |
|--|-------------------------|----------------------------|-------|--|
| 2  | Inputs<br>SI 2 & SI 6   | SI 2 & SI 6<br>diagnosis   | Off   | Normal operation                                   |
|  |                         |                            | Red   | Cross-fault or external power<br>to SI 2 or SI 6   |
| 3  | Inputs<br>SI 3 & SI 7   | SI 3 & SI 7<br>diagnosis   | Off   | Normal operation                                   |
|  |                         |                            | Red   | Cross-fault or external power<br>to SI 3 or SI 7   |
| 4  | Input SI 0              | SI 0 state                 | Off   | No valid input signal on channel 0, logical "0"    |
|  |                         |                            | Green | 24 VDC supplied to channel 0, logical "1"          |
| 5  | Input SI 1              | SI 1 state                 | Off   | No valid input signal on channel 1, logical "0"    |
|  |                         |                            | Green | 24 VDC supplied to channel 1, logical "1"          |
| 6  | Input SI 2              | SI 2 state                 | Off   | No valid input signal on channel 2, logical "0"    |
|  |                         |                            | Green | 24 VDC supplied to channel 2, logical "1"          |
| 7  | Input SI 3              | SI 3 state                 | Off   | No valid input signal on channel 3, logical "0"    |
|  |                         |                            | Green | 24 VDC supplied to channel 3, logical "1"          |
| 8  | Input SI 4              | SI 4 state                 | Off   | No valid input signal on channel 4, logical "0"    |
|  |                         |                            | Green | 24 VDC supplied to channel 4, logical "1"          |
| 9  | Input SI 5              | SI 5 state                 | Off   | No valid input signal on channel 5, logical "0"    |
|  |                         |                            | Green | 24 VDC supplied to channel 5, logical "1"          |
| 10   | Input SI 6              | SI 6 state                 | Off   | No valid input signal on channel 6, logical "0"    |
|  |                         |                            | Green | 24 VDC supplied to channel 6, logical "1"          |
| 11   | Input SI 7              | SI 7 state                 | Off   | No valid input signal on channel 7, logical "0"    |
|  |                         |                            | Green | 24 VDC supplied to channel 7, logical "1"          |
| 18   | Inputs<br>SI 8 & SI 12  | SI 8 & SI 12<br>diagnosis  | Off   | Normal operation                                   |
|  |                         |                            | Red   | Cross-fault or external power<br>to SI 8 or SI 12  |
| 19   | Inputs<br>SI 9 & SI 13  | SI 9 & SI 13<br>diagnosis  | Off   | Normal operation                                   |
|  |                         |                            | Red   | Cross-fault or external power<br>to SI 9 or SI 13  |
| 20   | Inputs<br>SI 10 & SI 14 | SI 10 & SI 14<br>diagnosis | Off   | Normal operation                                   |
|  |                         |                            | Red   | Cross-fault or external power<br>to SI 10 or SI 14 |
| 21   | Inputs<br>SI 11 & SI 15 | SI 11 & SI 15<br>diagnosis | Off   | Normal operation                                   |
|  |                         |                            | Red   | Cross-fault or external power<br>to SI 11 or SI 15 |
| 22   | Input SI 8              | SI 8 state                 | Off   | No valid input signal on channel 8, logical "0"    |
|  |                         |                            | Green | 24 VDC supplied to channel 8, logical "1"          |
| 23   | Input SI 9              | SI 9 state                 | Off   | No valid input signal on channel 9, logical "0"    |
|  |                         |                            | Green | 24 VDC supplied to channel 9, logical "1"          |
| 24   | Input SI 10             | SI 10 state                | Off   | No valid input signal on channel 10, logical "0"   |
|  |                         |                            | Green | 24 VDC supplied to channel 10, logical "1"         |
| 25   | Input SI 11             | SI 11 state                | Off   | No valid input signal on channel 11, logical "0"   |
|  |                         |                            | Green | 24 VDC supplied to channel 11, logical "1"         |
| 26   | Input SI 12             | SI 12 state                | Off   | No valid input signal on channel 12, logical "0"   |
|  |                         |                            | Green | 24 VDC supplied to channel 12, logical "1"         |
| 27   | Input SI 13             | SI 13 state                | Off   | No valid input signal on channel 13, logical "0"   |
|  |                         |                            | Green | 24 VDC supplied to channel 13, logical "1"         |
| 28   | Input SI 14             | SI 14 state                | Off   | No valid input signal on channel 14, logical "0"   |

| LEDs "Channel"; Safe digital inputs SI 0 .. SI 7 |             |             |       |  |
|--|-------------|-------------|-------|--|
|  |             |             | Green | 24 VDC supplied to channel 14, logical "1"       |
| 29   | Input SI 15 | SI 15 state | Off   | No valid input signal on channel 15, logical "0" |
|  |             |             | Green | 24 VDC supplied to channel 15, logical "1"       |

**Note, information**

- The red "diagnosis" LEDs are disabled if the safe digital inputs are used without the safe digital test pulse outputs.
- The green "status" LEDs of the inputs will indicate the presence of a 24 VDC signal at an input even if that input has not been set up in the configuration.

### 5.4.4.3 "Channel" LEDs of Kuhnke FIO Safety SDI8 SDO2

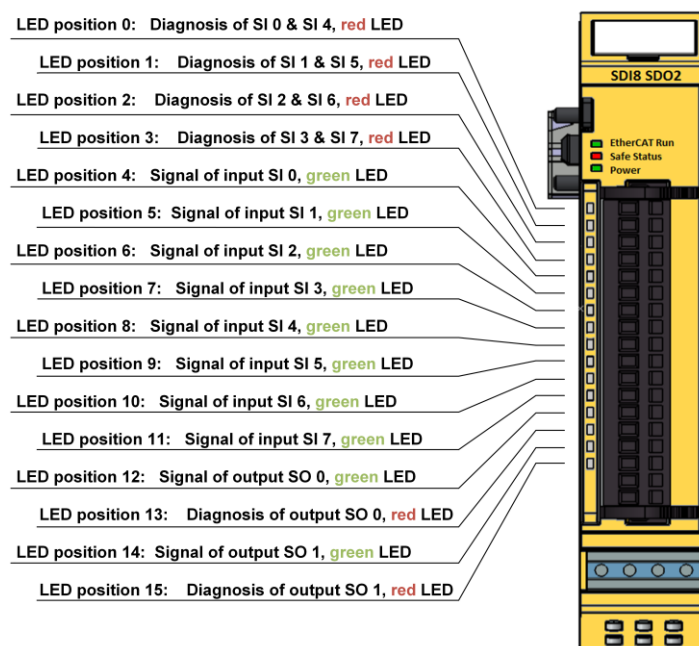

| LEDs "Channel"; Safe digital inputs SI 0 .. SI 7 |                    |                       |       |   |
|--|--------------------|-----------------------|-------|---|
| LED position                                     | Channel            | Function              | LED   | Explanation                                     |
| 0  | Inputs SI 0 & SI 4 | SI 0 & SI 4 diagnosis | Off   | Normal operation                                |
|  |                    |                       | Red   | Cross-fault or external power to SI 0 or SI 4   |
| 1  | Inputs SI 1 & SI 5 | SI 1 & SI 5 diagnosis | Off   | Normal operation                                |
|  |                    |                       | Red   | Cross-fault or external power to SI 1 or SI 5   |
| 2  | Inputs SI 2 & SI 6 | SI 2 & SI 6 diagnosis | Off   | Normal operation                                |
|  |                    |                       | Red   | Cross-fault or external power to SI 2 or SI 6   |
| 3  | Inputs SI 3 & SI 7 | SI 3 & SI 7 diagnosis | Off   | Normal operation                                |
|  |                    |                       | Red   | Cross-fault or external power to SI 3 or SI 7   |
| 4  | Input SI 0         | SI 0 state            | Off   | No valid input signal on channel 0, logical "0" |
|  |                    |                       | Green | 24 VDC supplied to channel 0, logical "1"       |
| 5  | Input SI 1         | SI 1 state            | Off   | No valid input signal on channel 1, logical "0" |

| LEDs "Channel"; Safe digital inputs SI 0 .. SI 7 |            |            |       |   |
|--|------------|------------|-------|---|
|  |            |            | Green | 24 VDC supplied to channel 1, logical "1"       |
| 6  | Input SI 2 | SI 2 state | Off   | No valid input signal on channel 2, logical "0" |
|  |            |            | Green | 24 VDC supplied to channel 2, logical "1"       |
| 7  | Input SI 3 | SI 3 state | Off   | No valid input signal on channel 3, logical "0" |
|  |            |            | Green | 24 VDC supplied to channel 3, logical "1"       |
| 8  | Input SI 4 | SI 4 state | Off   | No valid input signal on channel 4, logical "0" |
|  |            |            | Green | 24 VDC supplied to channel 4, logical "1"       |
| 9  | Input SI 5 | SI 5 state | Off   | No valid input signal on channel 5, logical "0" |
|  |            |            | Green | 24 VDC supplied to channel 5, logical "1"       |
| 10   | Input SI 6 | SI 6 state | Off   | No valid input signal on channel 6, logical "0" |
|  |            |            | Green | 24 VDC supplied to channel 6, logical "1"       |
| 11   | Input SI 7 | SI 7 state | Off   | No valid input signal on channel 7, logical "0" |
|  |            |            | Green | 24 VDC supplied to channel 7, logical "1"       |



### Note, information

- The red "diagnosis" LEDs are disabled if the safe digital inputs are used without the safe digital test pulse outputs.
- The green "status" LEDs of the inputs will indicate the presence of a 24 VDC signal at an input even if that input has not been set up in the configuration.

| LEDs "Channel"; Safe digital outputs SO 0 and SO 1 |             |           |       |   |
|--|-------------|-----------|-------|---|
| LED position                                       | Channel     | Function  | LED   | Explanation                               |
| 12   | Output SO 0 | Status    | Off   | No output signal at output 0, logical "0" |
|  |             |           | Green | Output signal at output 0, logical "1"    |
| 13   | Output SO 0 | Diagnosis | Off   | Normal operation                          |
|  |             |           | Red   | External power supply or cross-fault      |
| 14   | Output SO 1 | Status    | Off   | No output signal at output 1, logical "0" |
|  |             |           | Green | Output signal at output 1, logical "1"    |
| 15   | Output SO 1 | Diagnosis | Off   | Normal operation                          |
|  |             |           | Red   | External power supply or cross-fault      |

## 5.5 Operating Software

The FSoE master's configuration tool is used for operation and configuration. Refer to the FSoE master user guide for further information and details.



## 6 Installation and Operation

Before installing the Kuhnke FIO Safety Module, verify that it has been transported and stored at the ambient conditions specified in sections → 4.10 Transport and Storage and → 4.5 Technical Data.

Module operation is subject to the service conditions specified in section → 4.5 Technical Data.

|   |  |
|---|--|
|  | <b>CAUTION</b>   |
|   | <p><b><i>Inappropriate operation</i></b><br/> <i>Malfunction of Kuhnke's FIO Safety I/O module</i></p> <ul style="list-style-type: none"> <li>• Only persons qualified for dealing with safety matters are allowed to add, replace and put Safety I/O Modules into operation.</li> <li>• Before installing, servicing or putting Kuhnke FIO Safety I/O Module into service, please also read the safety information in the preface of this document.</li> <li>• Before putting the unit into service, verify that all safety functions work as specified.</li> </ul> |

### 6.1 General Notes on Installation

As component parts of machines, facilities and systems, electronic control systems must comply with valid rules and regulations, depending on their field of application.

General requirements concerning the electrical equipment of machines and aiming at the safety of these machines are contained in Part 1 of European Standard EN 60204 (same as VDE 0113).

|   |  |
|---|--|
|  | <b>Note, information</b>   |
|   | <i>In order to safely install Kuhnke's FIO Safety System, please read section → 2.2.7 Project Planning and Installation and following.</i> |

#### Interference emission

Interfering emission of electromagnetic fields, HF  
 compliant to EN 55011, limiting value class A, Group 1

|   |   |
|---|---|
|  | <b>Note, information</b>  |
|   | <i>If the controller is designed for use in residential areas, high-frequency emissions must comply with limiting value class B as described in EN 55011.<br/>     Fitting the controller into earthed metal cabinets and installing filters in the supply lines may produce a shielding compliant to the above standard.</i> |

The design and immunity to interference of programmable logic controllers are internationally governed by standard IEC 61131-2 which, in Europe, has been the basis for European Standard EN 61131-2.

|   |  |
|---|--|
|  | <b>Note, information</b>   |
|   | <i>Refer to IEC 61131-4, User's Guideline, for general installation instructions to be complied with to ensure that hardware interface factors and the ensuing noise voltages are limited to tolerable levels.</i> |

#### Electrical immission safeguard

To eliminate electromagnetic interference, connect the control system to the protective earth conductor. Practice best cable routing.

## Cable routing and wiring

Keep power circuits separate from control circuits:

- DC voltages                                    60 V ... 400 V
- AC voltages                                    25 V ... 400 V

Common laying of control circuits is possible in the following cases:

- shielded data signals
- shielded analogue signals
- unshielded digital I/O lines
- unshielded DC voltages < 60 V
- unshielded AC voltages < 25 V

|   |  |
|---|--|
|  | <b>CAUTION</b>   |
|   | <p><b>The safe wiring method depends on the application</b></p> <p><i>The safety function may be lost</i></p> <p>Safely wire up the signal lines if the application requires it. Take heed of the information in section 6</p> |

## Location of installation

Ensure that temperatures, contaminations, impact, vibration or electromagnetic interference are no impediment to the installation.

Please also note 6.2 Mechanical Installation.

## Temperature

Consider heat sources such as general heating of rooms, sunlight, heat accumulation in assembly rooms or control cabinets.

## Contamination

Use suitable casings to avoid possible negative influences due to humidity, corrosive gas, liquid or conducting dust.

## Impact and vibration

Consider possible influences caused by motors, compressors, transfer lines, presses, ramming machines and vehicles.

## Electromagnetic interference

Consider electromagnetic interference from various local sources: motors, switching devices, switching thyristors, radio-controlled devices, welding equipment, arcing, switched-mode power supplies, converters / inverters.

## Particular sources of interference: Inductive actuators

Switching off inductances (such as from relays, contactors, solenoids or switching magnets) produces surge voltages. It is necessary to reduce these extra voltages to a minimum.

Reducing elements may be diodes, Z-diodes, varistors or RC elements. Their rating should conform to the specifications provided by the manufacturer or supplier of the actuators.

# 6.2 Mechanical Installation

Environment of installation

Protect KUHKE FIO I/O against inadmissible contamination. Do not allow the units to contaminate more than specified for degree II in IEC 60664-3.

Whereas an enclosure providing IP 54 protection (e.g. an appropriate control cabinet) ensures that degree of contamination II is complied with, please consider that operation under condensing humidity is NOT allowed.



### WARNING

#### **Potentially hazardous failures due to contamination**

*Contaminations more severe, than those described for degree of contamination II of IEC 60664-3, may cause potentially hazardous failures.*

Do ensure that the operating environment complies with at least IP 54, e.g. by installing the unit in a suitable control cabinet.

## 6.2.1 Mounting Position

Kuhnke FIO I/Os mount on 35 mm rails to DIN EN 50022. Mount the rail horizontally and make sure that the modules' multiple socket connectors are pointing away from the wall. To ensure that enough air gets in through the ventilation slots, leave at least 20 mm to the top and 35 mm to the bottom of a module and any adjacent devices or cabinet surfaces. Leave at least 20 mm of lateral distance to third-party units and cabinet surfaces.

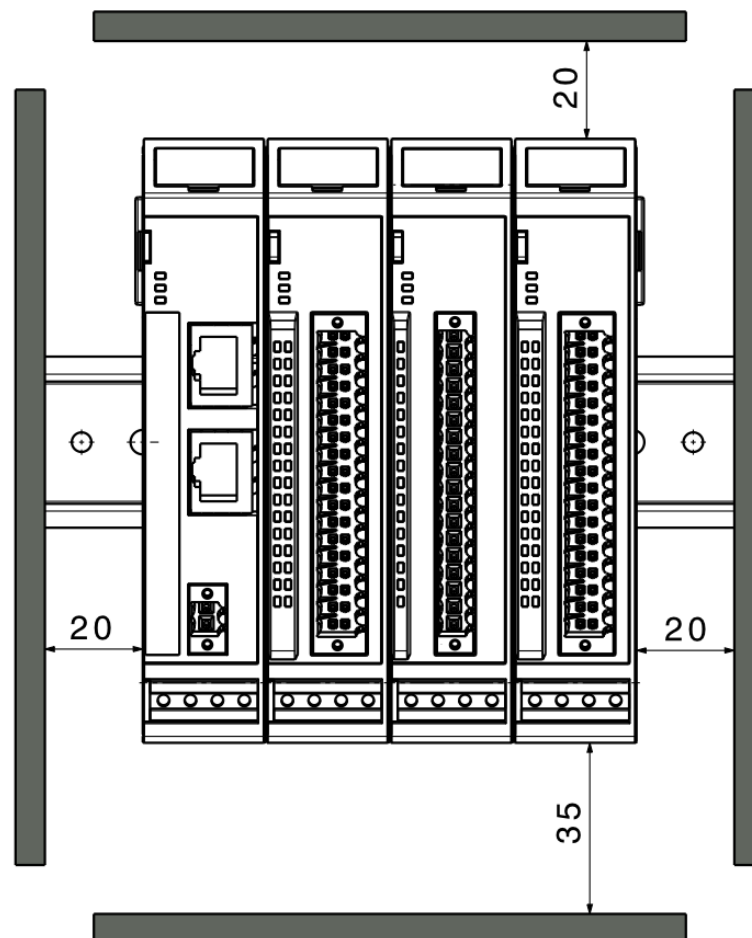

### CAUTION

**Do not operate the FIO Safety I/O module out of the specified range**

*Faults by component overload caused by excessive temperature*

|  |   |
|--|---|
|  | Operate the module under the ambient conditions listed in section Technical Data only while observing the derating of the outputs – see section 6.3.10. |
|--|---|

### 6.2.2 Order of Modules in Multi-FIO Systems

Power to the logic circuitry of the safe I/O modules is drawn from the 5 V of the backplane bus. Withdrawing the required current will also provoke a drop in the backplane bus voltage. The more modules there are on the backplane bus, the further the voltage may drop. The safe I/O modules monitor the 5 V supply to the logical circuit and change to the safe state when there is not enough voltage for sustained operation. Remember the fact when installing the system.

|   |   |
|---|---|
|  | <b>Note, information</b>  |
|   | <p><b>Order of modules in multi-FIO systems</b></p> <p><i>In order to ensure that the entire FIO system works properly, arrange the FIO modules by their specific E-bus load, placing the modules with the highest E-bus load immediately next to the head module (bus coupler or controller). Take account of the head module's maximum bus load. If possible, place the Kuhnke FIO Safety I/O module immediately next to the head module.</i></p> |

|   |   |
|---|---|
|  | <b>Note, information</b>  |
|   | <p><i>Stick to the order of modules set in Codesys because it will otherwise be impossible to get the system operational.</i></p> |

### 6.2.3 Snapping on a Single Module

- ⇒ Push up the module against the mounting rail from below, allowing the metal spring to snap in between mounting rail and mounting area as illustrated.
- ⇒ Push the top of the module against the mounting wall until it snaps in.

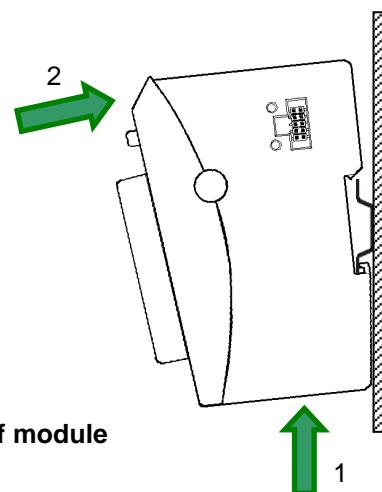

Figure 3: Rail mounting of module

### 6.2.4 Interconnecting Two Modules

- ⇒ After snapping on the first module to the rail, snap on the second module about 1 cm away towards the right of the first module.
- ⇒ Push the second module along the rail towards the first module until you hear the locking device snap in. Correctly mounting the modules is the only way of ensuring that the system works properly.

- ⇒ To prevent inadmissible contamination, mount the cover of the module bus connectors on the rightmost module of the FIO system.

**CAUTION****Short circuit fault of module bus contacts**

A short of the module bus contacts may cause the communication with the safe module to fail.  
Verify that the cover of the module bus connector is mounted on the rightmost module of the FIO system.

### 6.2.5 Disconnecting Two Modules

- ⇒ Push down the unlock button (see Figure 4) of the module that you wish to disconnect from the module to the left of it.
- ⇒ With the button still pressed, push both modules away from one another until they are about 1 cm apart.

### 6.2.6 Taking Down a Single Module

- ⇒ Push the module up and against the metal spring located on the underside of the rail guide.
- ⇒ Tip the module away from the rail as shown in the illustration.
- ⇒ Pull the module down and out of the mounting rail.

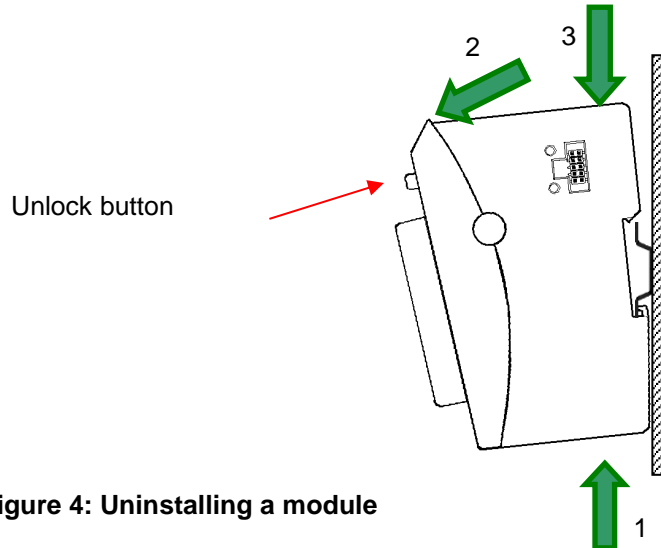





Figure 4: Uninstalling a module

## 6.3 Electrical Installation

|   |  |
|---|--|
|  | <b>WARNING</b>   |
|   | <p><b>Potentially hazardous failures due to wrong voltages supplied</b></p> <p><i>Supplying the wrong voltages may damage or destroy the unit and may provoke potentially hazardous failures.</i></p> <p><i>Preventive measures:</i></p> <ul style="list-style-type: none"> <li>• Only use PELV/SELV-ready power supply units to EN50178 or EN60950-1 to supply 24 VDC to             <ul style="list-style-type: none"> <li>○ the I/Os of FIO Safety I/O</li> <li>○ the bus couplers or compact PLCs that Kuhnke FIO Safety I/O modules are connected to</li> <li>○ the sensors and actuators connected to the Kuhnke FIO Safety I/O modules.</li> </ul> </li> <li>• Check that your upstream bus coupler or the compact PLC is protected against reversing the 24 V supply voltage.</li> <li>• Only use the GND terminal to connect the power supply unit to earth (PELV system). Do not use earthing variants that connect earth to +24V.</li> <li>• Remember that, even in case of a fault, a maximum voltage of <math>U_{max.} &lt; 33 \text{ V}</math> may be supplied to these assemblies.</li> <li>• Do not reuse but replace units operated on voltages <math>&gt; 33 \text{ V}</math> because such voltages may irreversibly damage the unit.</li> <li>• To ensure that there is as little interference as possible, install a central power supply point and establish a star topology of as short wires as possible between the central point and the block of FIO modules.</li> </ul> |

|   |   |
|---|---|
|  | <b>CAUTION</b>  |
|   | <p><b>Danger caused by improper installation under voltage</b></p> <p><i>Failure of Kuhnke's FIO Safety I/O module</i></p> <p>Always de-energise Kuhnke's FIO Safety I/O module before installing it.</p> |

### 6.3.1 Earthing

|   |   |
|---|---|
|  | <b>WARNING</b>  |
|   | <p><b>Danger of malfunction caused by EMC interference!</b></p> <p><i>Improperly installing the modules may provoke malfunction of the modules by EMC interference.</i></p> <p><i>Preventive measures:</i></p> <ul style="list-style-type: none"> <li>• Properly earth the module.</li> <li>• Look at the entire chain, i.e.: earth the module, DIN rail, electrical cabinet etc.</li> <li>• Check the earthing in conformity with VDE 0100.</li> </ul> |

Connect the Kuhnke FIO modules to earth by attaching the metal housing to functional earth. Since the functional earth connector dissipates HF and surge currents, it is of utmost importance for the module's noise immunity.

HF interference is dissipated from the electronics board to the metal housing. The metal housing therefore needs to be suitably connected to a functional earth connector. You would normally ensure that the connection between the module housing and the DIN rail as well as the connection between the DIN rail and the control cabinet conducts well and that the control cabinet is properly connected to earth.

In exceptional cases, you may connect earth directly to the front of the module.

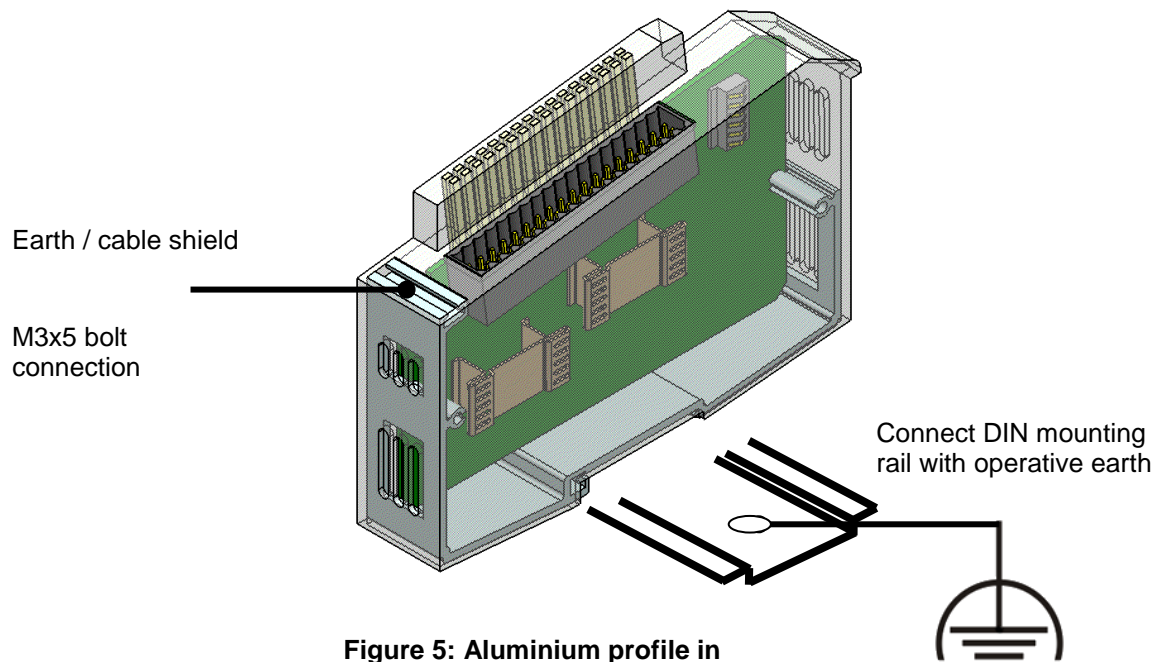

**Figure 5: Aluminium profile in the FIO module**



**Note, information**

*Earth wires should be short and have a large surface (copper mesh). Refer to [http://de.wikipedia.org/wiki/ground\\_\(electronics\)](http://de.wikipedia.org/wiki/ground_(electronics)) for further details*



**Note, information**

*When installing production or other lines, measure the earth potential of the DIN rail as specified in the applicable guidelines (earth test to VDE 0100). Measuring the earth potential must show that every protective earthing and operational earthing is within the boundaries set by the applicable standards. Also consider the repeat testing frequency resulting from the hazard assessment.*

### 6.3.2 Ground connection

When connecting the ground potential (GND or "L-") of the module and the connected actuators, the following instructions must be observed:

- ⇒ Use a separate GND line for each actuator to a common GND potential rail and no GND sum lines which can cause a critical error for two or more actuators due to a single error.
- ⇒ Non-safety-relevant output modules and their actuators must be routed to the GND potential rail via their own GND line and must not share a GND line with safety-relevant functions!
- ⇒ Ensure a safe connection of the module GND potential ("L-", pin 17 and pin 35 of the front connector of the modules) with the GND potential rail.

Observe these instructions when connecting the actuator. See section 6.3.9 Actuator Connection and the warnings there.

### 6.3.3 Module Interconnection

The FIO modules electrically connect by completely pushing the modules together. This automatically connects the modules to both the EtherCAT bus and the system power supply. If possible, place the Kuhnke FIO Safety I/O module immediately next to the head module. Refer to section 6.1 General Notes on Installation for details about how to interconnect two modules.

Please note that the maximum current supplied by the bus coupler limits the number of FIO modules you may connect to a single block.

### 6.3.4 System Power Supply

A system connector supplies the Kuhnke FIO Safety I/O system with system power from an upstream bus coupler or a compact controller. This system power supply is used only for the analysis circuitry and for bus communication.

|   |  |
|---|--|
|  | <b>Note, information</b>   |
|   | <i>Please take note of the system power supply details provided in the operating instructions of the upstream bus couplers or compact PLCs as well as the additional system power supply instruction in this user guide.</i> |

### 6.3.5 I/O Supply

The I/O supply of the safe outputs and the associated test pulse outputs connects to terminals L+ and L-. The supply voltage is rated at 24 VDC. It is monitored. In case of overvoltage (> +27.5%) and low voltage (> -25%) alike, the module changes to its safe state.

The cord must have external protection against short circuit and overload triggering at max. 10 A.

Power to Kuhnke FIO Safety I/O may be supplied by PELV/SELV-ready 24 VDC power supply units to EN50178 / EN60950-1 only. This applies to both the system power supply → 6.3.4 System Power Supply and the I/O supply → 6.3.5 I/O Supply.

|   |   |
|---|---|
|  | <b>CAUTION</b>  |
|   | <p><b>Module defect by reversing the polarity of the voltage supplied</b></p> <p><i>Although Kuhnke's FIO Safety I/O module is reverse polarity-proof, reversing the polarity will still put considerable stress on the electronic circuitry and may cause module defects!</i></p> <ul style="list-style-type: none"> <li>• Avoid a reversal of polarity.</li> <li>• Before starting to operate the module, check its wiring for a potentially wrongly connected I/O power supply.</li> </ul> |

|   |   |
|---|---|
|  | <b>Note, information</b>  |
|   | <p><b>Module response to brief voltage interruptions</b></p> <p><i>Kuhnke's FIO Safety I/O module permanently monitors the I/O power and the states of all inputs and outputs. Voltage interruptions will change the state of the outputs which, in turn, will provoke the fail-safe state because voltage interruptions cannot be distinguished from other faults.</i></p> <p>Voltage interruptions may have a severity of up to level PS1 (1 ms).</p> |

You can reset the module if the supply voltage fails completely (see section Wrong Supply Voltage 6.6.5).

In case the supply of power is interrupted the module will change to the safe state and output the appropriate error code to the service block → 6.6.7 Error Code.

Refer to section 6.6 Diagnosis for further details on how the module responds to a non-conforming supply of power.



### I/O power supply fusing

The cord must have external protection against short circuit and overload triggering at max. 10 A, min. 60 v.

|  |                       |
|--|-----------------------|
|   | <p><b>WARNING</b></p> |
| <p><b>Risk of fire due to short circuit!</b><br/> <i>A short circuit in the module or the power supply lines may cause the system to overheat or provoke a fire.</i><br/> <b>Preventive measures:</b><br/>                 Install a fuse triggering at max. 10 A.</p> |                       |

### 6.3.6 Sensor and Actuator Power Supply

All sensors and actuators of the FIO Safety I/O system supplied with power from an external source must still run on safe low operating voltage (SELV/PELV). This power may also be fed to the I/Os of the FIO Safety I/O module.

### 6.3.7 Power Supply Wiring Example

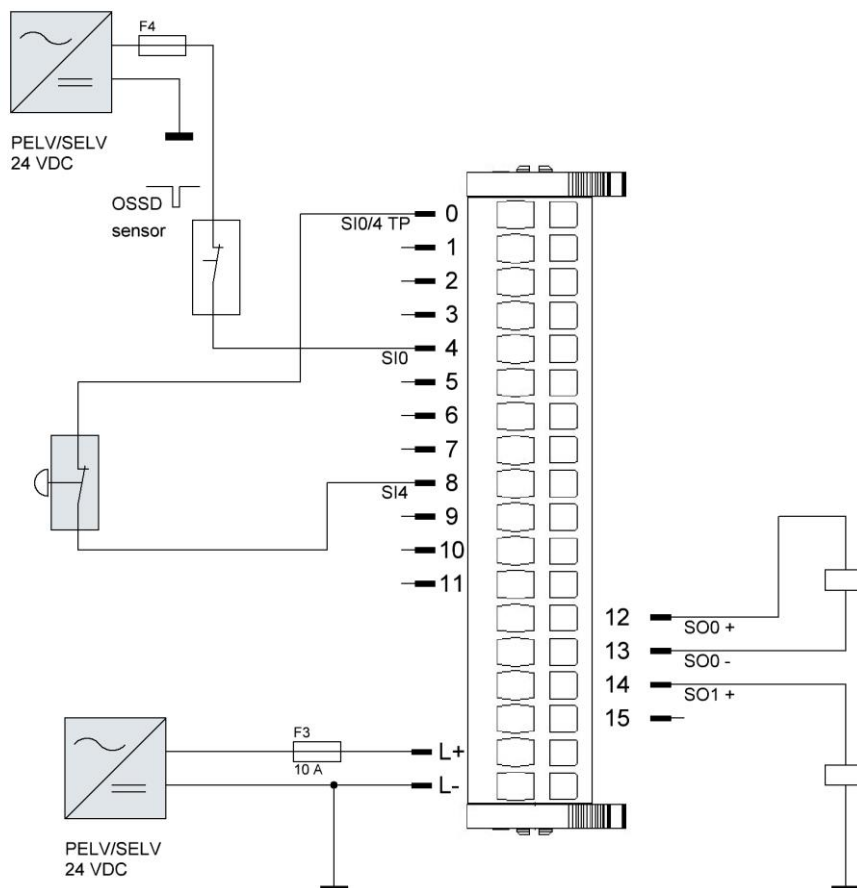

### 6.3.8 Sensor Connection

The FIO Safety I/O modules accept contact-type sensors connected to the module's own test pulse outputs or external sensors equipped with OSSD outputs. Choose the type of sensor when configuring the module -> refer to section 6.4.3 Input Parameters.

You may also set the parameters to completely disabling the inputs. If so, they will always return logical null to the safe PLC, i.e. irrespective of the voltage supplied to the input.

|   |   |
|---|---|
|  | <b>Note, information</b>  |
|   | <p><b>Note on configuring the inputs</b></p> <p>Specifically configured inputs (e.g. inputs set up for external sensors (External Inputs parameter) or mode selector = on) are expected to be actually used by the application. Therefore, you may not also disable such inputs in the configuration ("Input not used"). If you do, the module will discover a bad configuration.</p> |

#### General safety information on using the inputs

|   |  |
|---|--|
|  | <b>WARNING</b>   |
|   | <p><b>Non-detection of a corrupt external wiring when test pulse outputs are disabled</b><br/><i>Unsafe machine state, safety hazard</i></p> <p>You may use parameter <i>External Inputs</i> to set up the safe module inputs for external sensors. Such inputs will neither be expected to send test pulses nor will they be checked for such pulses. Consequently, the external sensors must provide means of detecting wiring corruptions. Using passive safety switchgear without test pulses will make it impossible to detect external wiring corruptions.</p> <ul style="list-style-type: none"> <li>• Always use the correct and enabled test pulse output to supply power to contact-type sensors.</li> <li>• Do not link inputs to the associated test pulse output if they are set up for external sensors by parameter <i>External Inputs</i> because such inputs will ignore the test pulses and therefore render the functional safety ineffective.</li> </ul> |

|   |   |
|---|---|
|  | <b>WARNING</b>  |
|   | <p><b>Do not directly link the module inputs to the 24 V power supply</b><br/><i>Safety hazard.</i></p> <p><i>Increased EMC noise levels on the supply lines may provoke malfunctions of the inputs. Without test pulses, cross-faults between the inputs cannot be detected.</i></p> <p>In general, use of the safe inputs is only permitted with the module's own test pulse outputs, with OSSD outputs from external sensors or with digital outputs from controllers.</p> |

|   |   |
|---|---|
|  | <b>CAUTION</b>  |
|   | <p><b>Safe function jeopardised by cross-faults with other modules</b><br/><i>Improper installation in conjunction with other modules may cause malfunctions due to cross-faults at the contacts</i></p> <p>When test pulses are enabled, the Kuhnke FIO Safety I/O module will detect cross-faults between the inputs / outputs and other signal lines of the same module. Note that you must prevent cross-faults with the security functions of other modules. You should therefore protect the signal lines and/or lay them separately.</p> |

|   |  |
|---|--|
|  | <b>CAUTION</b>   |
|   | <p><b>No wiring of disabled or inactive test pulse outputs</b><br/> <i>Connected inputs may turn on inadvertently or the safety function may be installed wrongly.</i></p> <ul style="list-style-type: none"> <li>• Test pulse outputs both of whose inputs have been disabled or have been set up for external sensors (External Inputs parameters) turn off.</li> <li>• Do not wire up test pulse outputs not used for a safety function.</li> <li>• The test pulse outputs are solely designed for the function with the associated safe inputs.</li> </ul> |

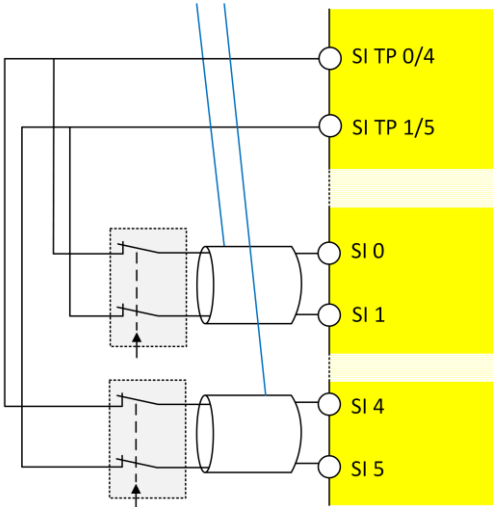
|   |  |
|---|--|
|  | <b>CAUTION</b>   |
|   | <p><b>Safe wiring required</b><br/> <i>A cross-fault between a safe input and the associated test pulse signal will reduce the two-channel characteristic when assessing initial faults.</i></p> <p><b>Example #1:</b> <i>A cross-fault between safe input "Safe-In 0" and the associated test pulse output "Safe In 0/4 TP" will be considered a steadily running piece of safety switchgear and, thus, as an active safe input.</i></p> <p><b>Example #2:</b> <i>A cross-fault between safe input "Safe-In 0" and another safe input "Safe In 4" supplied by the same associated test pulse signal will also be considered a steadily running piece of safety switchgear and, thus, as an active safe input.</i></p> <p><i>The application must prevent both cases because they will both lead to the safe module not being detected.</i></p> <ul style="list-style-type: none"> <li>• Prevent cross-faults by safely wiring up the lines.</li> </ul> <p style="color: blue;">Fault exclusion:<br/>Safe wiring required</p>  <p>The diagram shows a terminal block with six terminals. From top to bottom: SI TP 0/4, SI TP 1/5, SI 0, SI 1, SI 4, and SI 5. SI 0 and SI 1 are connected to a common input device. SI 4 and SI 5 are connected to another common input device. Blue lines represent cross-faults: one from SI TP 0/4 to SI 0, and another from SI TP 1/5 to SI 0.</p> <ul style="list-style-type: none"> <li>• Another option of detecting potential wiring faults is to periodically test the safety function by operating the safety switchgear. This requires the operator to make the required test and repeat it at sufficiently close intervals.</li> </ul> |

### Allocation of safe outputs to the test pulse outputs

|   |  |
|---|--|
|  | <b>CAUTION</b>   |
|   | <p><b>Do not use two inputs with the same test pulse signal for any one safety function</b><br/> <i>Faulty wiring will not be detected.</i></p> <ul style="list-style-type: none"> <li>• The inputs used for a safety function must not be supplied power from the same test pulse output.</li> <li>• Correct example:<br/>Use SI0 with SI 0/4 TP and SI1 with SI 1/5 TP for the same safety function.</li> <li>• <b>Incorrect</b> example:</li> </ul> |

Use SI0 with **SI 0/4 TP** and SI4 with **SI 0/4 TP** for a safety function.  
(Impermissible!)

Allocation of safe inputs to the test pulse outputs (Kuhnke FIO Safety SDI16 and Kuhnke FIO Safety SDI16 SDO4 0.5A):

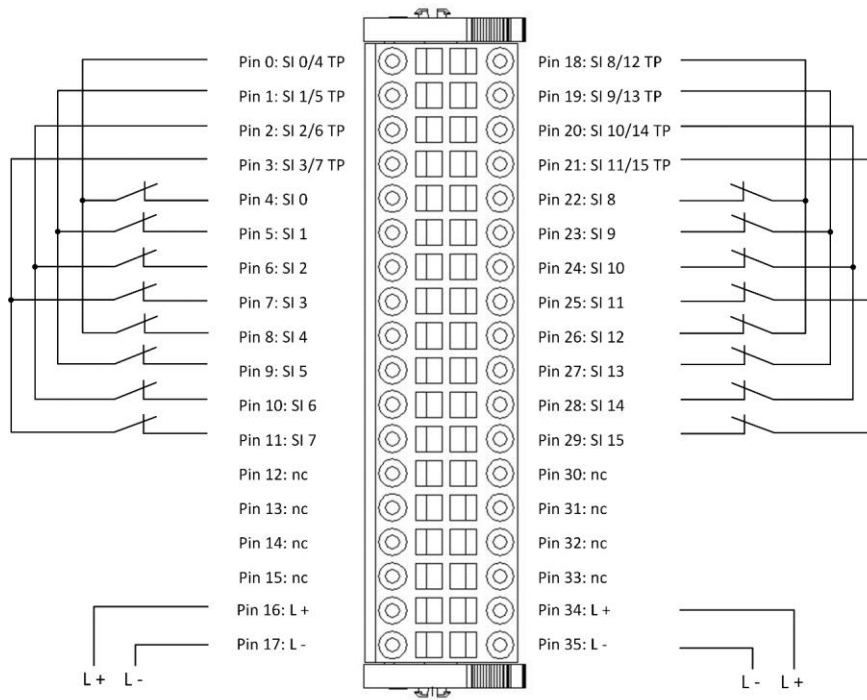

| Connector X1 |                                    |  |
|--------------|------------------------------------|--|
| Pin          | Function                           | Associated signal                          |
| 0            | Test pulse output Safe-In 0/4 TP   | Safe input Safe-In 0 – pin 4               |
|              |                                    | Safe input Safe-In 4 – pin 8               |
| 1            | Test pulse output Safe-In 1/5 TP   | Safe input Safe-In 1 – pin 5               |
|              |                                    | Safe input Safe-In 5 – pin 9               |
| 2            | Test pulse output Safe-In 2/6 TP   | Safe input Safe-In 2 – pin 6               |
|              |                                    | Safe input Safe-In 6 – pin 10              |
| 3            | Test pulse output Safe-In 3/7 TP   | Safe input Safe-In 3 – pin 7               |
|              |                                    | Safe input Safe-In 7 – pin 11              |
| 4            | Safe input Safe-In 0               | Test pulse output Safe-In 0/4 TP – Pin0    |
| 5            | Safe input Safe-In 1               | Test pulse output Safe-In 1/5 TP – Pin1    |
| 6            | Safe input Safe-In 2               | Test pulse output Safe-In 2/6 TP – Pin2    |
| 7            | Safe input Safe-In 3               | Test pulse output Safe-In 3/7 TP – Pin3    |
| 8            | Safe input Safe-In 4               | Test pulse output Safe-In 0/4 TP – Pin0    |
| 9            | Safe input Safe-In 5               | Test pulse output Safe-In 1/5 TP – Pin1    |
| 10           | Safe input Safe-In 6               | Test pulse output Safe-In 2/6 TP – Pin2    |
| 11           | Safe input Safe-In 7               | Test pulse output Safe-In 3/7 TP – Pin3    |
| 18           | Test pulse output Safe-In 8/12 TP  | Safe input Safe-In 8 – pin 22              |
|              |                                    | Safe input Safe-In 12 – pin 26             |
| 19           | Test pulse output Safe-In 9/13 TP  | Safe input Safe-In 9 – pin 23              |
|              |                                    | Safe input Safe-In 13 – pin 27             |
| 20           | Test pulse output Safe-In 10/14 TP | Safe input Safe-In 10 – pin 24             |
|              |                                    | Safe input Safe-In 14 – pin 28             |
| 21           | Test pulse output Safe-In 11/15 TP | Safe input Safe-In 11 – pin 25             |
|              |                                    | Safe input Safe-In 15 – pin 29             |
| 22           | Safe input Safe-In 8               | Test pulse output Safe-In 8/12 TP – Pin18  |
| 23           | Safe input Safe-In 9               | Test pulse output Safe-In 9/13 TP – Pin19  |
| 24           | Safe input Safe-In 10              | Test pulse output Safe-In 10/14 TP – Pin20 |
| 25           | Safe input Safe-In 11              | Test pulse output Safe-In 11/15 TP – Pin21 |
| 26           | Safe input Safe-In 12              | Test pulse output Safe-In 8/12 TP – Pin18  |
| 27           | Safe input Safe-In 13              | Test pulse output Safe-In 9/13 TP – Pin19  |
| 28           | Safe input Safe-In 14              | Test pulse output Safe-In 10/14 TP – Pin20 |
| 29           | Safe input Safe-In 15              | Test pulse output Safe-In 11/15 TP – Pin21 |

Allocation of safe inputs to the test pulse outputs (Kuhnke FIO Safety SDI8 / SDO2 0.5A):

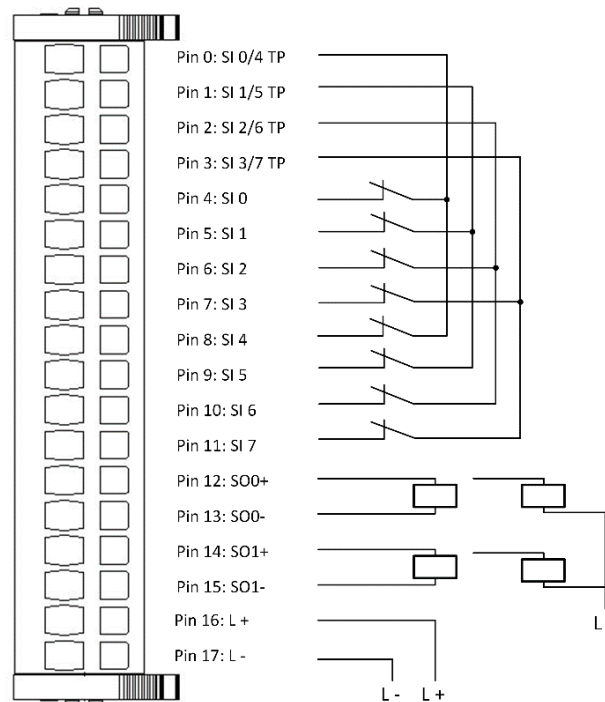

**Connector X1**

| Pin | Function                         | Associated signal   |
|-----|----------------------------------|---|
| 0   | Test pulse output Safe-In 0/4 TP | Safe input Safe-In 0 – pin 4<br>Safe input Safe-In 4 – pin 8  |
| 1   | Test pulse output Safe-In 1/5 TP | Safe input Safe-In 1 – pin 5<br>Safe input Safe-In 5 – pin 9  |
| 2   | Test pulse output Safe-In 2/6 TP | Safe input Safe-In 2 – pin 6<br>Safe input Safe-In 6 – pin 10 |
| 3   | Test pulse output Safe-In 3/7 TP | Safe input Safe-In 3 – pin 7<br>Safe input Safe-In 7 – pin 11 |
| 4   | Safe input Safe-In 0             | Test pulse output Safe-In 0/4 TP – Pin0                       |
| 5   | Safe input Safe-In 1             | Test pulse output Safe-In 1/5 TP – Pin1                       |
| 6   | Safe input Safe-In 2             | Test pulse output Safe-In 2/6 TP – Pin2                       |
| 7   | Safe input Safe-In 3             | Test pulse output Safe-In 3/7 TP – Pin3                       |
| 8   | Safe input Safe-In 4             | Test pulse output Safe-In 0/4 TP – Pin0                       |
| 9   | Safe input Safe-In 5             | Test pulse output Safe-In 1/5 TP – Pin1                       |
| 10  | Safe input Safe-In 6             | Test pulse output Safe-In 2/6 TP – Pin2                       |
| 11  | Safe input Safe-In 7             | Test pulse output Safe-In 3/7 TP – Pin3                       |

Single-channel contact-type sensor

|  |                       |
|--|-----------------------|
|   | <p><b>CAUTION</b></p> |
| <p><b>Setting the Test Pulse Rate</b></p> <p><i>In single-channel applications (inputs same as outputs), adapt the test pulse frequency to the application. In applications with frequent changes of state, the test pulse frequency should be at least 100x higher than the time of change of application state.</i></p> <p><i>In single-channel applications, the error response time of the inputs should be 3x the test pulse interval (25 Hz = 120 ms).</i></p> |                       |

|  |
|--|
| Refer to section 6.4.2 "FSoE Parameters" |
|--|

The inputs of single-channel contact-type sensors work entirely separate from one another. Wiring should take account of the fact that every input signal is allocated to a single test pulse output.

This allocation allows the system to detect cross-faults at the connector.

Use the configuration to separately enable each of the inputs → 6.4.3 Input Parameters.

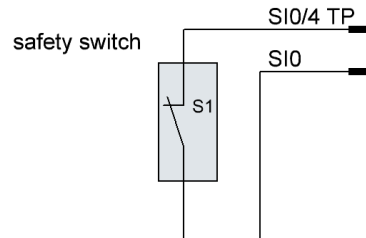

#### Analysis of states

The module checks the states of the inputs and transfers the result to the safe control unit.

The process data image of a safe input transfers

- "0" if a "0" signal is supplied to the input **or** if an error has been detected;
- "1" if a "1" signal is supplied to the input **or** if an error has not been detected.

Refer to section → 7.1 Safety Function with Single-channel Input for connection examples.

#### Two-channel contact-type sensors

Two-channel contact-type sensors allow different inputs to be connected to the test pulse output of a two-channel sensor. A software module of the safe control unit provides the required analysis of the input signals.

The software can be used to interconnect any of the safe inputs. Wiring should take account of the fact that every input signal is allocated to the test pulse output. You must use the configuration to enable the safe inputs you use → 6.4.3 Input Parameters.

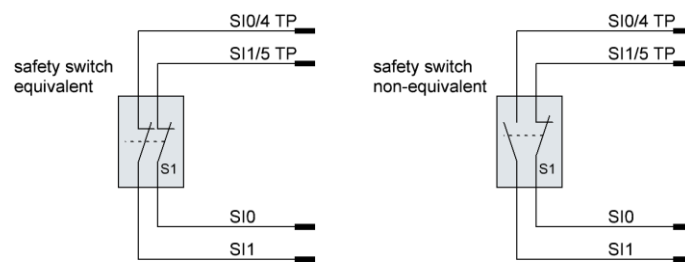

The process data image of a safe input transfers

- "0" if a "0" signal is supplied to the input **or** if an error has been detected;
- "1" if a "1" signal is supplied to the input **or** if an error has not been detected.

Refer to section → 7.2 Safety Function with Two-channel Input for connection examples.

### Multi-channel contact-type sensors

Multi-channel switches such as mode selectors or switchgear with a "toggle" functionality connect to several safe inputs. Remember, though, that the correct function is provided only if test pulse outputs SI 0/4 TP and SI 8/12 TP (Kuhnke FIO Safety SDI16 SDO4 0.5A or Kuhnke FIO Safety SDI16) are used. Use the configuration to enable the safe inputs you use and parameter Rotary Switch to choose the mode selector function → 6.4.3 Input Parameters and 7.4 Mode Selector, Rotary .

Switches with 2 to 8 channels can be analysed.

safety mode selector switch

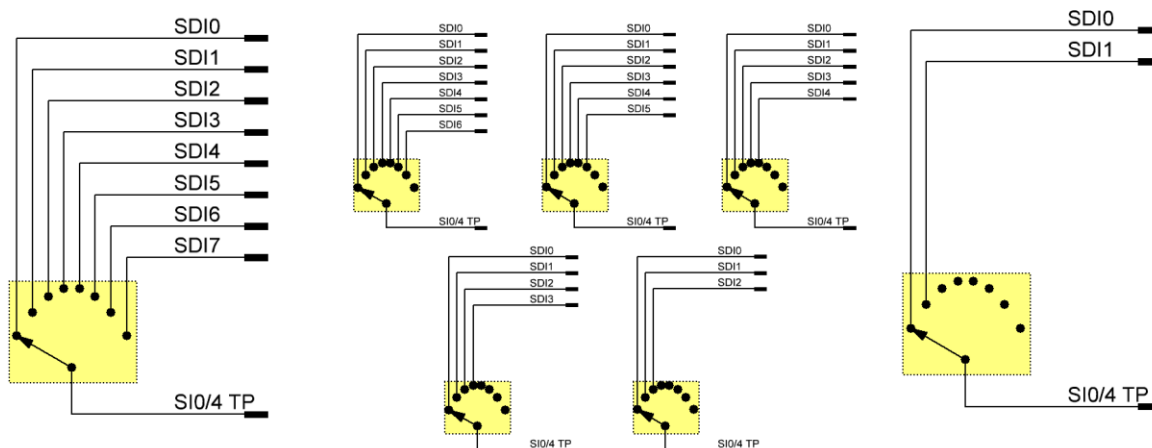

#### Allocation of safe inputs for the mode selector function

| No. of channels | Safe inputs to use                                   | Clock signal |
|-----------------|--|--------------|
| 2               | SI 0, SI 1   | SI 0/4 TP    |
|                 | SI 8, SI 9   | SI 8/12 TP   |
| 3               | SI 0, SI 1, SI 2                                     | SI 0/4 TP    |
|                 | SI 8, SI 9, SI 10                                    | SI 8/12 TP   |
| 4               | SI 0, SI 1, SI 2, SI 3                               | SI 0/4 TP    |
|                 | SI 8, SI 9, SI 10, SI 11                             | SI 8/12 TP   |
| 5               | SI 0, SI 1, SI 2, SI 3, SI 4                         | SI 0/4 TP    |
|                 | SI 8, SI 9, SI 10, SI 11, SI 12                      | SI 8/12 TP   |
| 6               | SI 0, SI 1, SI 2, SI 3, SI 4, SI 5                   | SI 0/4 TP    |
|                 | SI 8, SI 9, SI 10, SI 11, SI 12, SI 13               | SI 8/12 TP   |
| 7               | SI 0, SI 1, SI 2, SI 3, SI 4, SI 5, SI 6             | SI 0/4 TP    |
|                 | SI 8, SI 9, SI 10, SI 11, SI 12, SI 13, SI 14        | SI 8/12 TP   |
| 8               | SI 0, SI 1, SI 2, SI 3, SI 4, SI 5, SI 6, SI 7       | SI 0/4 TP    |
|                 | SI 8, SI 9, SI 10, SI 11, SI 12, SI 13, SI 14, SI 15 | SI 8/12 TP   |

Safe inputs you do not use are available for other functions.

|   |   |
|---|---|
|  | <p><b>Note, information</b></p>   |
|   | <p><b>Use of safe inputs along with the mode selector mode</b></p> <p>Two safe inputs are allocated to every test pulse output. If a mode selector is used, you may still use inputs SI 4 and SI 12 (if available) with the associated test pulse output (SI 0/4 TP / SI8/12 TP).</p> |



PLCopen module "Mode Selector" or a similar module of the safe control unit is used for multi-channel analysis. The achievable category to EN ISO 13849-1 depends on the switching device's error model (e.g. mode selector) and must needs be analysed in conjunction with the PLCopen module's error detection. Refer to section → 7.4 Mode Selector, Rotary for connection examples.

|   |   |
|---|---|
|  | <b>Note, information</b>  |
|   | <p><b>Time discrepancy in mode selector/rotary table mode</b></p> <p>A set time discrepancy of 100 ms has been implemented for signals missing at the inputs when changing to mode selector mode.</p> |

## Electronic sensors, OSSD sensor

The OSSD sensor provides the fault detection function when connecting an OSSD sensors. Depending on the sensor's diagnostic functions, the retrieval of signals by the sensor itself is able to detect cross-faults between the 24 V power supply and earth as well as cross-faults between the sensor signals.

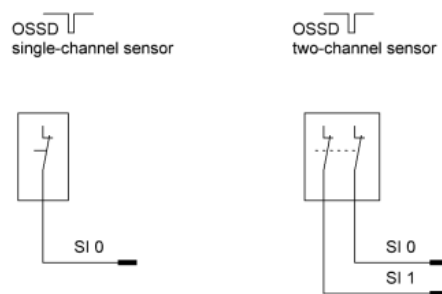



### Wiring of sensors providing OSSD signals

Two-channel sensors delivering OSSD signals can be connected to any safe input of the Kuhnke FIO Safety I/O module. A software module of the safe control unit provides the required allocation and analysis of the input signals.

Sensors with OSSD signals do not support the module's test pulses. You must therefore set the input channels to "External Inputs" = 1 → 6.4.3 Input Parameters. A safe input configured like that can no longer diagnose external faults such as cross-faults or supply of external power. The sensor connected to it must provide this function.

Use parameter "Input x filter time" to set the filter time of the digital inputs in case you are working with external safety sensors. You may have to modify the test pulse duration if the signals are affected by capacitive properties of the input circuit, for example.

|   |   |
|---|---|
|  | <b>CAUTION</b>  |
|   | <p><b>Avoid the carrying over of voltages</b></p> <p><i>Malfunction and module defects are likely.</i></p> <p>To prevent that voltages are carried over, provide a low-impedance interconnection between GND and the chassis ground of the unit supplying power to the sensors and actuators and the unit supplying 24 VDC to the I/Os of the Kuhnke FIO Safety I/O module.</p> |

|   |  |
|---|--|
|  | <b>Note, information</b>   |
|   | <p><b>Test pulse output signal of inputs set up for external sensors</b></p> <p>Test pulse signals are no longer generated if both inputs allocated to the test pulse output have been set up for "Input External" or to "Input not used".</p> |

Pressure-sensitive mat, bumper

|   |   |
|---|---|
|  | <b>CAUTION</b>  |
|   | <p><b>Lay the feed lines of pressure-sensitive mats and bumpers together</b><br/> <i>EMC interference may provoke malfunctions.</i></p> <p>In order to avoid influences and malfunctions due to EMC effects, lay the four wires (e.g. Safe-In 0, Safe-In 0/4 TP, Safe-In 1, Safe-In 1/5 TP) together.</p> |

|   |   |
|---|---|
|  | <b>CAUTION</b>  |
|   | <p><b>"Short circuit in mat" fault is not detected</b><br/> <i>The safe I/O module fails to detect a short circuit between the mat contacts. This is interpreted as the mat being actuated. You must also verify that the safeguard is wired correctly.</i></p> <p>Periodically check that the mat is working properly.</p> |

|   |   |
|---|---|
|  | <b>CAUTION</b>  |
|   | <p><b>Safety function pressure-sensitive mat requires a response time of 25 ms</b><br/> <i>Avoid personal injury and damage to property</i></p> <p>The pressure-sensitive mat function achieves a response time of 25 ms between a change in mat state and providing the information on the EtherCAT bus.</p> |

Pressure-sensitive mats and bumpers are used to safeguard the floor around a machine. The mats are placed in the danger zone and make the control unit change to its safe functional state whenever pressure is exerted on them. If so, the I/O module sends a null signal to the control unit.

Kuhnke's FIO Safety I/O module supports four-wire mats. Two safe digital inputs and the associated test pulse output are used for one mat / bumper.

You must use the configuration to enable the safe inputs you use and parameter Safety Mat to choose the bumper function → 6.4.3 Input Parameters.

You may use up to two mat channels.

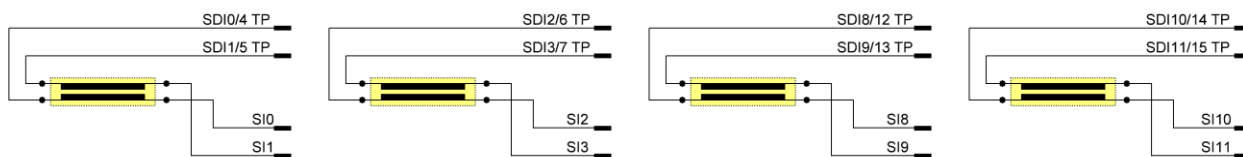

**Allocation of safe inputs for the bumper function**

| Parameters "Safety Mats 0" to "Safety Mats 3" |   | Safe inputs to use                                      | Test pulse output to use |
|---|---|---|--------------------------|
| Safety Mats 0                                 | 0 | Pressure-sensitive mat / bumper function 1 not selected | none                     |
| Safety Mats 0                                 | 1 | SI 0 and SI 1   | SI 0/4 TP and SI 1/5 TP  |
| Safety Mats 1                                 | 0 | Pressure-sensitive mat / bumper function 2 not selected | none                     |
| Safety Mats 1                                 | 1 | SI 2 and SI 3   | SI 2/6 TP and SI 3/7 TP  |

| Allocation of safe inputs for the bumper function |   |   |                             |
|---|---|---|-----------------------------|
| Safety Mats 2                                     | 0 | Pressure-sensitive mat / bumper function 3 not selected | none                        |
| Safety Mats 2                                     | 1 | SI 8 and SI 9   | SI 8/12 TP and SI 9/13 TP   |
| Safety Mats 3                                     | 0 | Pressure-sensitive mat / bumper function 4 not selected | none                        |
| Safety Mats 3                                     | 1 | SI 10 and SI 11   | SI 10/14 TP and SI 11/15 TP |

Safe inputs not needed for the pressure-sensitive mat may be used for external sensors.

|   |   |
|---|---|
|  | <b>Note, information</b>  |
|   | <p><b>Use of safe inputs along with the pressure-sensitive mats / bumper</b></p> <p>Two safe inputs are allocated to every test pulse output. If a pressure-sensitive mat / bumper is used, the inputs not involved in providing the function must not be allocated to the associated test pulse outputs but set up as External Inputs instead.</p> |

PLCopen module "SF\_ESPE" or a similar module of the safe control unit is used for mat / bumper analysis. The achievable category to EN ISO 13849-1 depends on the switching device's error model and must needs be analysed in conjunction with the PLCopen module's error detection.

Refer to section → 7.5 Safety Mats, Connecting Blocks and Bumpers for connection examples.

### 6.3.9 Actuator Connection

Resistive loads, inductive loads and resistive loads with some capacitive fractions can be connected to the digital power outputs of the FIO Safety I/O module.

General safety information on using the outputs

|   |  |
|---|--|
|  | <b>CAUTION</b>   |
|   | <p><b>A current of 200 mA (typ.) may be fed back to output SOX+ if external power is supplied and a cross-fault occurs. This fact should be considered when planning the safety function.</b></p> <p><i>The module will recognise external power and cross-faults by the test pulses returned by all inputs and outputs. It will respond by enabling the safe state and turning off all outputs. External power or cross-faults at the outputs will cause current to flow into the module. If external power is supplied "downstream" the actuator (at the SOX connector), this may generate a current flow through the actuator and into the module, which may then activate an actuator.</i></p> <p><i>Take the following precautions if a reverse flow of 200 mA (typ.) may activate the load:</i></p> <ul style="list-style-type: none"> <li>• Use a two-channel actuation of a safety function with two safe outputs. A supply of external power or a cross-fault will be detected and enable the safe state of all module outputs.</li> <li>• Ensure that the line between the SOX connector and the actuator is laid safely. Preventing external power or a cross-fault between the SOX connector and the actuator will also prevent a dangerous flow of current through the load.</li> </ul> |

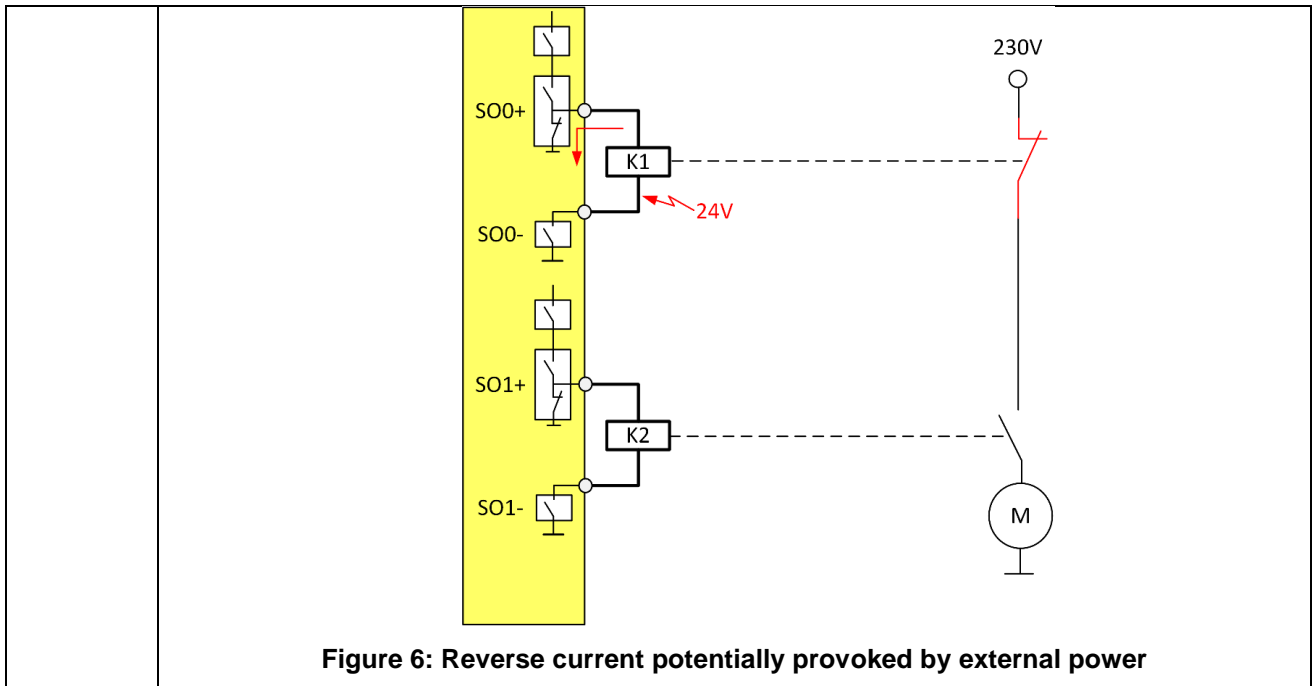

### CAUTION

**A break of the load's ground connection may generate safety-critical reverse currents**

Taking account of all contingent reverse currents, a break of the ground connection of one or several loads at the same time may turn on the load(s).

Take the following precautions if a reverse flow of 200 mA (typ.) may activate the load:

- Use a separate GND line for every actuator and connect it to a common GND potential busbar **instead** of connecting two or more actuators to the same GND line, along which a single fault may turn into a critical fault.
- Output modules and their actuators not relevant to safety must link to the GND potential busbar through separate GND lines. They must not share the same GND line with functions relevant to safety!
- Make sure that the module's GND potential ("L-", pins 17 and 35 of the connector at the front of the modules) safely links to the GND potential busbar.

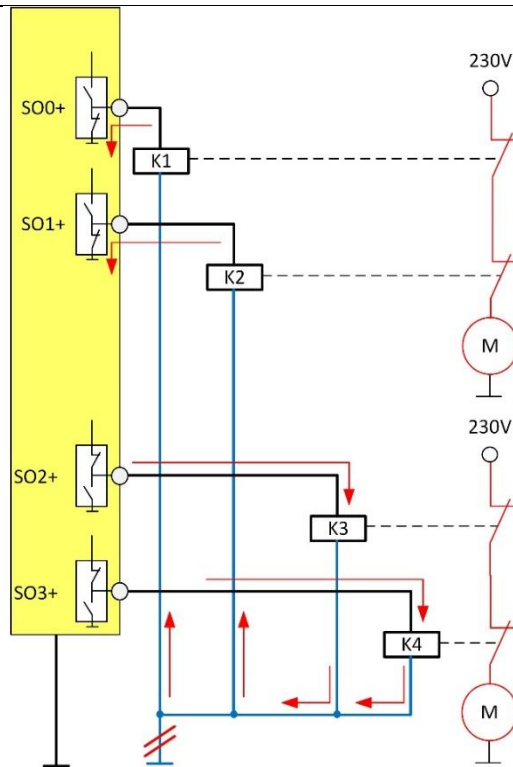

Figure 7: Dangerous state if the GND connection of several actuators is lost.

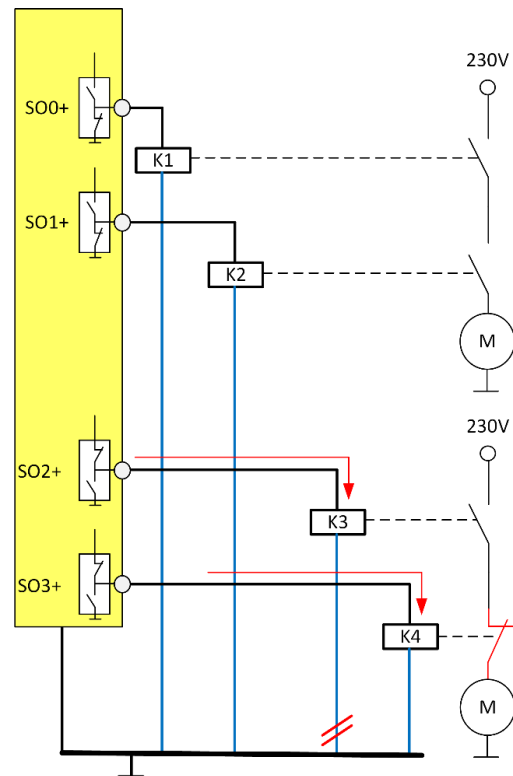

Figure 8: A GND potential busbar controls single faults and prevent current from flowing back into the module



### CAUTION

#### **External power from another network may provoke a defect of the safe I/O module**

The outputs' test pulses can detect a cross-fault or external power supplied to the module outputs and set the module to a safe state. External power of a higher voltage supplied to the module from another network and through the outputs may cause current to flow into the module and destroy it. Although this will jeopardise the availability of the module, the module will still achieve a safe state because the fault is detected and can be controlled safely.

- ⇒ Avoid the supply of external power from any source. Take particular care to safeguard the module against an external supply of higher mains voltages by implementing appropriate means in the application.
- ⇒ One such effective means could be to safely lay the output line.

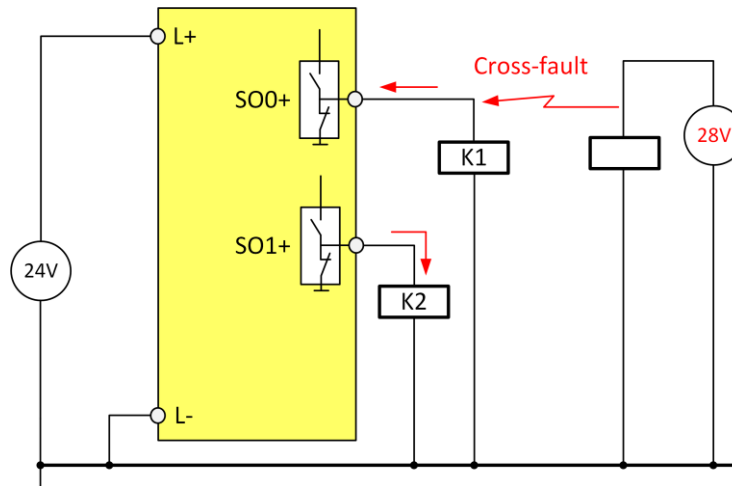

Figure 9: Avoid a supply of external power, particularly of higher mains voltages



### CAUTION

#### **Safe function jeopardised by cross-faults with other modules**

Improper installation in conjunction with other modules may cause malfunctions due to cross-faults at the contacts

- ⇒ When test pulses are enabled, the Kuhnke FIO Safety I/O module will detect cross-faults between the inputs / outputs and other signal lines of the same module. Note that you must prevent cross-faults with the security functions of other modules. You should therefore protect the signal lines and/or lay them separately.

## Output faults



### Note, information

#### **Faults at the outputs provoke a change to the fail-safe state - external fault**

The outputs are protected against overload and short circuit, see section → 4.5.4

Safe Digital Outputs for details. Overload and short circuit cause the module to change to its fail-safe state - external fault. The module responds in the same way to external power fed to and cross-faults at the outputs. In case the outputs are badly adapted to the loads (e.g. if a capacity is too high), test pulse may not be detected and cause the module to change to its fail-safe state.

### Actuators with active GND reference

As long as the parameter settings are taken into account, you are free to connect actuators to both output connectors (SOX+ and SOX-). This allows external power and cross-faults at the positive load connectors to be controlled by opening the module's GND reference.

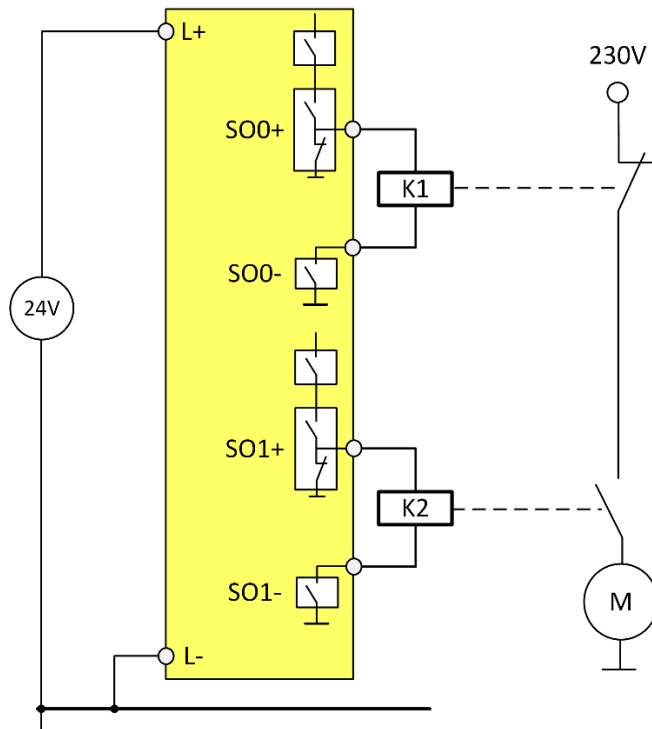

Figure 10: Actuators with active GND reference



### CAUTION

#### Wrong use of the module outputs

*Incorrect start of the safety function!*

- Do not use the module's SOX connectors to actuate the loads of a safety function.

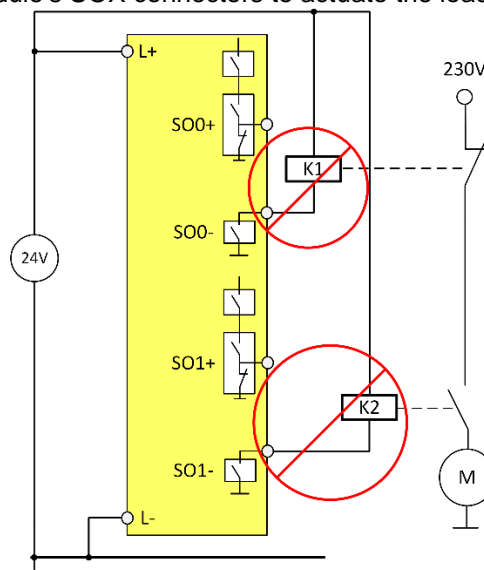

Figure 11: Do not use the SOX connectors to actuators any of the actuators.

- The module will prevent sustained operation.

### Actuators with external GND reference

Provided that the configuration is taken account of, actuators with external GND reference can be connected to the Kuhnke FIO Safety I/O module.

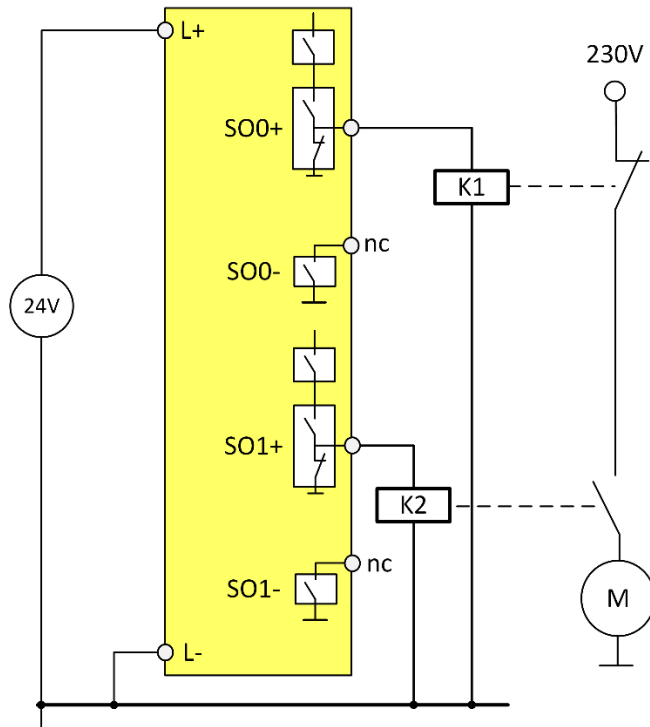

Figure 12: Actuators with external GND reference



#### CAUTION

##### **Avoid the carrying over of voltages**

*Malfunction and module defects are likely.*

To prevent that voltages are carried over, provide a low-impedance interconnection between GND and the chassis ground of the unit supplying power to the sensors and actuators and the unit supplying 24 VDC to the I/Os of the Kuhnke FIO Safety I/O module.



### Switching of inductive loads

If the internal free wheel circuit is enabled, the digital power outputs of the FIO Safety I/O module can be used to operate inductive loads. The graph below illustrates the maximum inductance of the load vs. the load current at a maximum output switching frequency of 2.5 Hz. The maximum inductance is limited to 10 H.

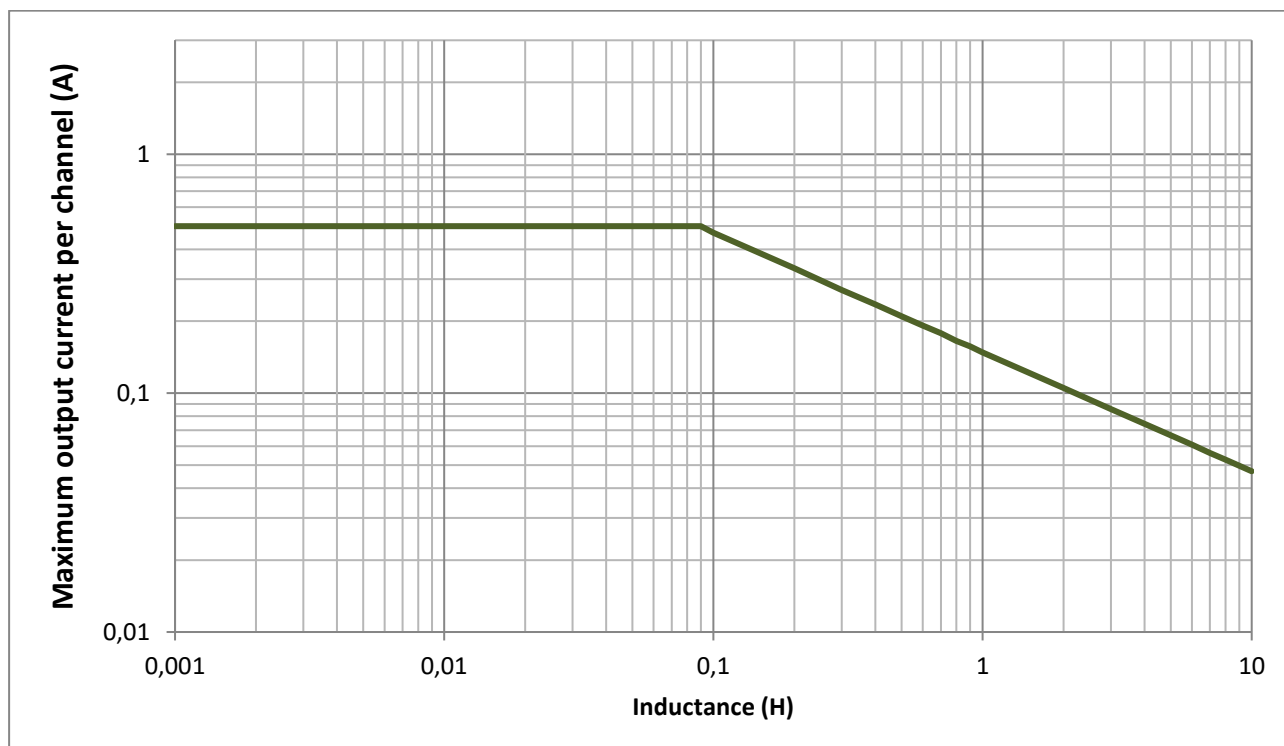

|   |  |
|---|--|
|  | <p><b>CAUTION</b></p> <p><b><i>Defect caused by thermal overload due to excessive inductance!</i></b></p> <p><i>Setting the inductance and the load current to higher than the specified values may thermally destroy the digital power output. Destroying the digital power output may cause the safety function to fail.</i></p> <p>⇒ Use an external free wheel circuit if the external load exceeds the specified inductance limits.</p> |
|---|--|

|   |   |
|---|---|
|  | <p><b>Note, information</b></p> <p><b><i>Take heed of the fast clearing by the internal free wheel circuit</i></b></p> <p>The internal free wheel circuit impacts the way the actuators (e.g. relays) release. The power dissipated in the module when turning off the outputs causes actuators to release faster than they would do if an external recovery diode was used. This should be considered with particular regard to the test pulses at a particular output. The actuators connected should not respond to the test pulses.</p> <p>Consider using an external recovery diode, depending on the actuator connected and the falling delay required.</p> |
|---|---|

## External free wheel circuit

**Note, information****Take heed of the perturbation of the external free wheel circuit**

Depending on the actual safety function, it may or may not be affected by the external free wheel circuit which the safety assessment must take account of.

An external free wheel circuit will transduce the magnetic energy when turning off the inductive load.

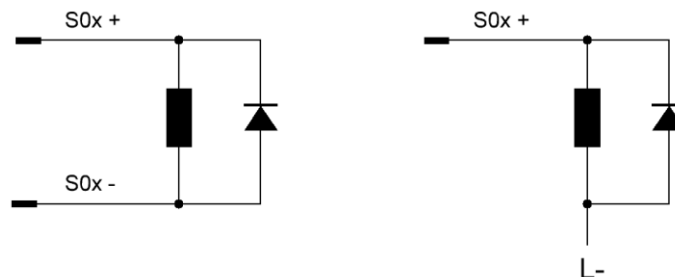

Verify that the external free wheel circuit is designed to withstand the ensuing dissipation heat.

When connecting the inductive load to the outputs, be sure to limit the voltage of the external free wheel element you choose to anything smaller than -30 V because the digital output will otherwise transduce the magnetic energy to heat.

**Note, information****Note the heat dissipated by the external free wheel element!**

*If you choose the correct external free wheel element, this element instead of the safe I/O module will transduce the magnetic energy when turning off the inductive load.*

Verify that the external free wheel circuit is designed to withstand the ensuing dissipation heat.

## Switching of digital inputs

Digital inputs of I/O modules can be switched by the module's SO X+ outputs. Verify that you have enabled parameter "extGroundOutput" of the output you use. Output test pulse configuration must consider the input capacitance of the input to be actuated. See the section on the switching of capacitive loads below.

To ensure that the test pulses of the digital power outputs are filtered properly when the safe digital inputs of the Safety IO module are used, the inputs' configurable filters should be set to the same test pulse duration (parameter "Test pulse duration") as the digital power output.

## Switching of capacitive loads

Switching of capacitive loads must take account of the limits below described with reference to the output current and the test pulse length.

Test pulses cyclically test the module's digital outputs. If a capacitive load is connected to the digital power output, you may have to modify the test pulse duration. A test pulse length not adapted to the load may cause the module to change to its safe state.

The outputs support loads connected to SOX+ and SOX- as well as to SOX+ and an external GND potential. Different maximum capacitive loads apply to both configurations because they are built around a different internal composition of the outputs. Every output supports a maximum capacitive load of 470  $\mu$ F.

### Output capacity of actuators with external GND reference or digital inputs to SOX+

| Test pulse length           | Output current 2 mA ... 0.5 A |
|-----------------------------|-------------------------------|
| 700 $\mu$ s to 1500 $\mu$ s | 470 nF                        |

### Output capacity of actuators with GND reference connected to SOX+ and SOX-

| Test pulse length | Output current 2 mA | Output current 20 mA |
|-------------------|---------------------|----------------------|
| 700 $\mu$ s       | 22 nF               | 300 nF               |
| 1000 $\mu$ s      | 43 nF               | 470 nF               |
| 1500 $\mu$ s      | 77 nF               | 470 nF               |

## 6.3.10 Derating the Modules with Reference to Their Ambient Temperature



### CAUTION

**Do not operate the FIO Safety I/O module out of the specified range**

*Faults by component overload*

Operate the module under the ambient conditions listed in section Technical Data only while observing the appropriate derating.

### Kuhnke FIO Safety SDI16 SDO4 0.5A

The maximum rated total current and the maximum number of available I/O module inputs depend on the ambient temperature of the safe I/O module. A derating is not required if the 24 V are supplied. If the maximum voltage of 28.8 V is supplied, refer to the diagram for the resulting total current and number of inputs to also be limited with reference to the temperature.

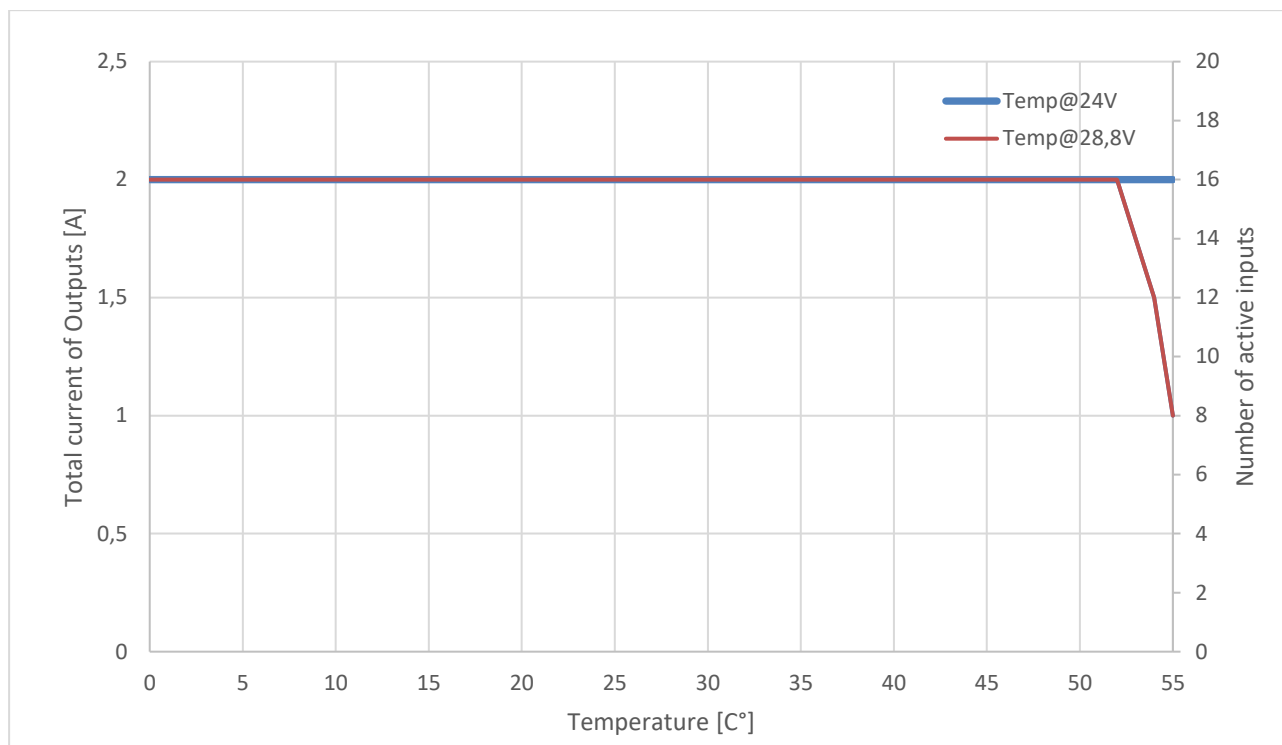

Figure 13: Derating of total output current and number of inputs

The output current derating shown on the graph was measured under free convection in a configuration with I/O modules on the left and right, 100% duty cycle and identical supply voltage.

Kuhnke FIO Safety SDI16 & Kuhnke FIO Safety SDI8 SDO2 0.5A

Derating not required.

### 6.3.11 Multiple Socket Connector (MSC)

|  |  |
|--|--|
|  | <p><b>CAUTION</b></p>  |
|  | <p><b>Safe function jeopardised by cross-faults with other modules</b><br/> <i>Improper installation in conjunction with other modules may cause malfunctions due to cross-faults at the contacts</i></p> <p>When test pulses are enabled, the Kuhnke FIO Safety I/O module will detect cross-faults between the inputs / outputs and other signal lines of the same module. Note that you must prevent cross-faults with the security functions of other modules. You should therefore protect the signal lines and/or lay them separately.</p> |
|  | <p><b>Note, information</b></p> <p><i>To avoid excessive force being exerted on the board or problems with the contacts, do not expose the connectors to inadmissibly high tension / pressure. One reason for too much pulling force is the wiring being too short.</i></p>  |
|  | <p><b>Note, information</b></p> <p><i>Only use the MSC from the package to connect to Kuhnke's FIO module.</i></p>   |

### Kuhnke FIO Safety SDI8 SDO2 0.5A

**Spring-assisted multiple socket connectors** support quick and easy wiring. Use the unlock button to easily disconnect the wires where there is little space.

Single row

|   |   |
|---|---|
| MSC model:  | Weidmüller, OMNIMATE Signal – BL/SL series 3.50                               |
| Tool:   | Screwdriver, 0.4 x 2.5 x 75 [mm] blade (DIN 5264-A)                           |
| Clamping range, rated connection                    | min. 0.2 mm <sup>2</sup> max. 1.5 mm <sup>2</sup>                             |
| Wire diameter AWG:                                  | min. AWG 25                      max. AWG 14                                  |
| Outside diameter of insulation:                     | max. 2.9 mm   |
| Wire diameter, single-wire:                         | min. H05(07) V-U 0.2 mm <sup>2</sup> ... max. H05(07) V-U 1.5 mm <sup>2</sup> |
| Wire diameter, fine wire:                           | min. H05(07) V-K 0.2 mm <sup>2</sup> ... max. H05(07) V-K 1.5 mm <sup>2</sup> |
| Wire diameter<br>w/ connector sleeve, DIN 46 228/1: | min. 0.2 mm <sup>2</sup> ... max. 1.5 mm <sup>2</sup> Wire diameter           |
| w/ connector sleeve w/ collar, DIN 46 228/4:        | min. 0.2 mm <sup>2</sup> ... max. 1 mm <sup>2</sup>                           |
| Stripped end:                                       | 10 mm   |
| Rated current:                                      | 10 A (CSA) / 10 A (UL)  |
| Thermal stability of cable:                         | min. 75 °C (UL)   |

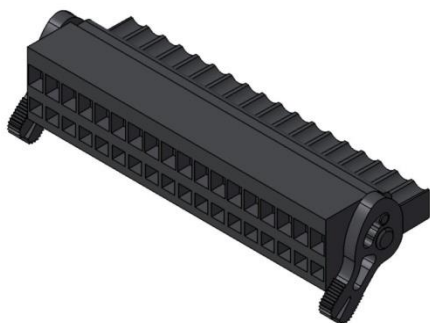

Single-row spring-assisted connector with releasing lever

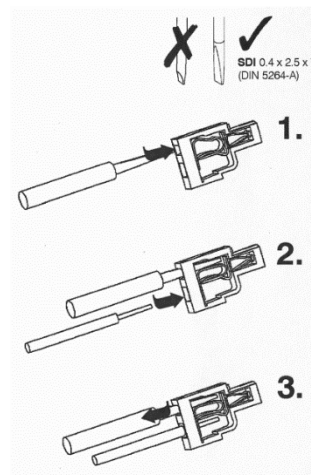

How to connect

|  |  |
|--|--|
|  | <b>Note, information</b>   |
|  | <p><b>Destruction by wrong tool</b><br/>                 Damage to Kuhnke's FIO Safety I/O module</p> <ul style="list-style-type: none"> <li>• Use suitable tools for wiring the multiple socket connector only!</li> <li>• Tool: Screwdriver, 0.4 x 2.5 x 75 [mm] blade (DIN 5264-A)</li> </ul> |

### Kuhnke FIO Safety SDI16 SDO4 0.5A & Kuhnke FIO Safety SDI16

**The spring-assisted PUSH-IN connector** allows you to quickly attach the wires by direct insertion without any tools. Just insert the connector sleeve end of the stripped solid or fine wire in the correct opening.

Two rows:

|                                   |   |
|-----------------------------------|---|
| MSC model:                        | Weidmüller, OMNIMATE Signal - series model B2C/S2C 3.50, two-row              |
| Clamping range, rated connection: | min. 0.2 mm <sup>2</sup> ... max. 1.5 mm <sup>2</sup>                         |
| Wire diameter AWG:                | min. AWG 25 ... max. AWG 16   |
| Outside diameter of insulation:   | max. 2.9 mm   |
| Wire diameter, single-wire:       | min. H05(07) V-U 0.2 mm <sup>2</sup> ... max. H05(07) V-U 1.5 mm <sup>2</sup> |

|   |   |
|---|---|
| Wire diameter, fine wire:                                     | min. H05(07) V-K 0.2 mm <sup>2</sup> ... max. H05(07) V-K 1.5 mm <sup>2</sup> |
| Wire diameter<br>w/ connector sleeve, DIN 46 228/1:           | min. 0.2 mm <sup>2</sup> ... max. 1.5 mm <sup>2</sup>                         |
| Wire diameter w/ connector sleeve w/<br>collar, DIN 46 228/4: | min. 0.2 mm <sup>2</sup> ... max. 1 mm <sup>2</sup>                           |
| Stripped end:   | 10 mm   |
| Rated current:  | 9.5 A (CSA) / 9.5 A (UL)  |
| Thermal stability of cable:                                   | min. 75 °C (UL)   |

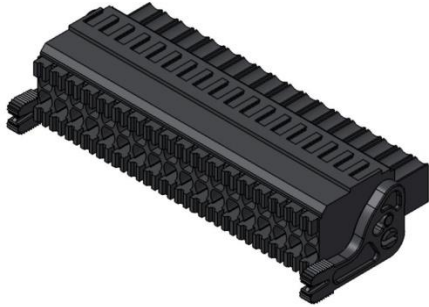

Two-row push-in connector with releasing lever

## 6.4 Configuration

|   |   |
|---|---|
|  | <b>Note, information</b>  |
|   | <p><b>Check the safety function</b><br/> <i>Potential faults due to maladjusted configuration</i></p> <ul style="list-style-type: none"> <li>• After initial installation and after replacing a module, check the safety function!</li> </ul> |

### 6.4.1 Address Setup

FIO Safety has a safe module address (FSoE slave address) which clearly identifies it in the safe communication network. The address is set manually by means of binary switches on the left side of the module.

Use the 8 DIP switches to set the FSoE address. Addresses range between 1 and 255.

|   |   |
|---|---|
|  | <b>CAUTION</b>  |
|   | <p><b><i>Destruction by wrong tool or operation</i></b><br/> <i>Damage to Kuhnke's FIO Safety I/O module</i></p> <ul style="list-style-type: none"> <li>• Use suitable tools for setting the address only!<br/>         Use a non-metal and suitable object (e.g. a plastic screwdriver) to set the DIP switches.</li> <li>• Do not exert pressure on the switching elements!</li> <li>• Do not start the module if any components inside are damaged! Replace the module instead!</li> </ul> |

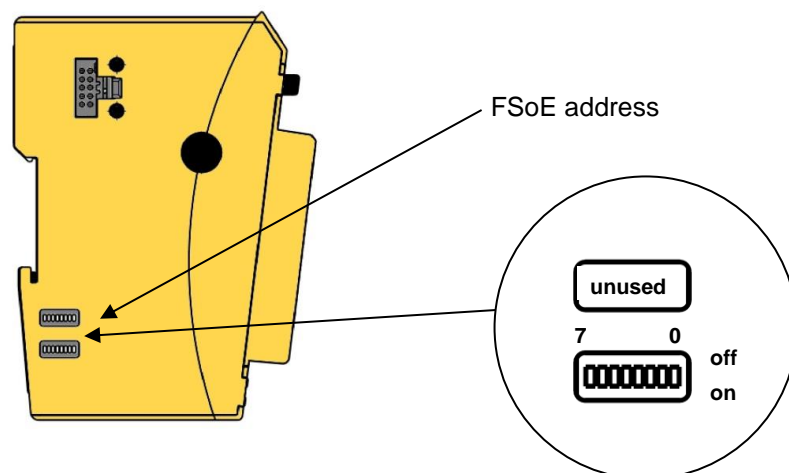

|   |  |
|---|--|
|  | <b>WARNING</b>   |
|   | <p><b><i>Potentially hazardous failures by starting damaged modules</i></b><br/> <i>Damages to the internal circuitry caused by wrong handling may jeopardise the safe use of the module.</i></p> <p>Do not start the module if any components inside are damaged! Replace the module instead!</p> |

**Attention****Safety function not available**

Startup disallowed by wrongly set address

Do a function test to verify that the address coding switches have been set correctly.

| Address          | DIP switch |     |     |     |     |     |     |     |
|------------------|------------|-----|-----|-----|-----|-----|-----|-----|
|                  | 7          | 6   | 5   | 4   | 3   | 2   | 1   | 0   |
| 0 (inadmissible) | OFF        | OFF | OFF | OFF | OFF | OFF | OFF | OFF |
| 1                | OFF        | OFF | OFF | OFF | OFF | OFF | OFF | ON  |
| 2                | OFF        | OFF | OFF | OFF | OFF | OFF | ON  | OFF |
| 3                | OFF        | OFF | OFF | OFF | OFF | OFF | ON  | ON  |
| ...              | ...        | ... | ... | ... | ... | ... | ... | ... |
| 255              | ON         | ON  | ON  | ON  | ON  | ON  | ON  | ON  |

**Note, information****Inappropriate setup actions at the Kuhnke FIO Safety I/O module**

Machine failure and damage to the FIO Safety module

Turn off the I/O supply before removing the FIO Safety module from the row of module for setup.

**Note, information**

The FSoE address you set may only occur once in the communication network. The master will find and notify the user of a FSoE address that occurs more than once or is not used.

**Note, information**

Stick to the order of modules set in Codesys because it will otherwise be impossible to get the system operational.

**Note, information**

There is no access to the DIP switches once several modules have been lined up.

To set the FSoE slave address at the DIP switch, first remove the module from the row of modules.

## 6.4.2 FSoE Parameters

**CAUTION****Improper operation of parameter setup**



Malfunction of Kuhnke's FIO Safety I/O module due to bad parameter setup

- Only persons qualified for dealing with safety matters are allowed to add, replace and put Safety I/O Modules into operation.
- Before installing, servicing or putting Kuhnke FIO Safety I/O Module into service, please also read the safety information in the preface of this document.
- Before putting the unit into service, verify that all safety functions work as specified.
- The module will not work if parameter settings are out of the specified valid range.



| FSoE parameter   |   |            |       |       |            |         |   |            |         |  |            |         |  |            |         |  |            |         |  |            |         |   |            |         |   |            |         |   |            |         |   |            |         |   |            |          |   |            |          |   |            |          |   |            |          |   |            |          |   |            |          |   |            |
|--|---|------------|-------|-------|------------|---------|---|------------|---------|--|------------|---------|--|------------|---------|--|------------|---------|--|------------|---------|---|------------|---------|---|------------|---------|---|------------|---------|---|------------|---------|---|------------|----------|---|------------|----------|---|------------|----------|---|------------|----------|---|------------|----------|---|------------|----------|---|------------|
| Parameter  |   | Unit       |       |       |            |         |   |            |         |  |            |         |  |            |         |  |            |         |  |            |         |   |            |         |   |            |         |   |            |         |   |            |         |   |            |          |   |            |          |   |            |          |   |            |          |   |            |          |   |            |          |   |            |
| Safety module Setting / range [Default]  | Description / note  |            |       |       |            |         |   |            |         |  |            |         |  |            |         |  |            |         |  |            |         |   |            |         |   |            |         |   |            |         |   |            |         |   |            |          |   |            |          |   |            |          |   |            |          |   |            |          |   |            |          |   |            |
| <b>FSoE address</b>  |   | -          |       |       |            |         |   |            |         |  |            |         |  |            |         |  |            |         |  |            |         |   |            |         |   |            |         |   |            |         |   |            |         |   |            |          |   |            |          |   |            |          |   |            |          |   |            |          |   |            |          |   |            |
| 1 ... 255 [1]  | FSoE slave address set at DIP switch  |            |       |       |            |         |   |            |         |  |            |         |  |            |         |  |            |         |  |            |         |   |            |         |   |            |         |   |            |         |   |            |         |   |            |          |   |            |          |   |            |          |   |            |          |   |            |          |   |            |          |   |            |
| <b>Connection ID</b>   |   | -          |       |       |            |         |   |            |         |  |            |         |  |            |         |  |            |         |  |            |         |   |            |         |   |            |         |   |            |         |   |            |         |   |            |          |   |            |          |   |            |          |   |            |          |   |            |          |   |            |          |   |            |
| 1 ... 65535 [1]  | Unique ID of the connection to a FSoE slave   |            |       |       |            |         |   |            |         |  |            |         |  |            |         |  |            |         |  |            |         |   |            |         |   |            |         |   |            |         |   |            |         |   |            |          |   |            |          |   |            |          |   |            |          |   |            |          |   |            |          |   |            |
| <b>WatchdogTime</b>  |   | ms         |       |       |            |         |   |            |         |  |            |         |  |            |         |  |            |         |  |            |         |   |            |         |   |            |         |   |            |         |   |            |         |   |            |          |   |            |          |   |            |          |   |            |          |   |            |          |   |            |          |   |            |
| 20 ... 65534 (0xFFFE) [500]  | Watchdog time of FSoE frame   |            |       |       |            |         |   |            |         |  |            |         |  |            |         |  |            |         |  |            |         |   |            |         |   |            |         |   |            |         |   |            |         |   |            |          |   |            |          |   |            |          |   |            |          |   |            |          |   |            |          |   |            |
| <b>Used Inputs</b>   |   | Dec        |       |       |            |         |   |            |         |  |            |         |  |            |         |  |            |         |  |            |         |   |            |         |   |            |         |   |            |         |   |            |         |   |            |          |   |            |          |   |            |          |   |            |          |   |            |          |   |            |          |   |            |
| SDI16 SDO4 and SDI16 Input0 - Input15<br><br>SDI8 SDO2 Input0 - Input7                                 | <p>Enables the inputs used. Selection from a drop-down list depends on the configurator.</p> <table border="1"> <thead> <tr> <th>Input</th> <th>Value</th> <th>Input used</th> </tr> </thead> <tbody> <tr><td>Input 0</td><td>1</td><td>Input used</td></tr> <tr><td>Input 1</td><td></td><td>Input used</td></tr> <tr><td>Input 2</td><td></td><td>Input used</td></tr> <tr><td>Input 3</td><td></td><td>Input used</td></tr> <tr><td>Input 4</td><td></td><td>Input used</td></tr> <tr><td>Input 5</td><td>1</td><td>Input used</td></tr> <tr><td>Input 6</td><td>1</td><td>Input used</td></tr> <tr><td>Input 7</td><td>1</td><td>Input used</td></tr> <tr><td>Input 8</td><td>1</td><td>Input used</td></tr> <tr><td>Input 9</td><td>1</td><td>Input used</td></tr> <tr><td>Input 10</td><td>1</td><td>Input used</td></tr> <tr><td>Input 11</td><td>1</td><td>Input used</td></tr> <tr><td>Input 12</td><td>1</td><td>Input used</td></tr> <tr><td>Input 13</td><td>1</td><td>Input used</td></tr> <tr><td>Input 14</td><td>1</td><td>Input used</td></tr> <tr><td>Input 15</td><td>1</td><td>Input used</td></tr> </tbody> </table> |            | Input | Value | Input used | Input 0 | 1 | Input used | Input 1 |  | Input used | Input 2 |  | Input used | Input 3 |  | Input used | Input 4 |  | Input used | Input 5 | 1 | Input used | Input 6 | 1 | Input used | Input 7 | 1 | Input used | Input 8 | 1 | Input used | Input 9 | 1 | Input used | Input 10 | 1 | Input used | Input 11 | 1 | Input used | Input 12 | 1 | Input used | Input 13 | 1 | Input used | Input 14 | 1 | Input used | Input 15 | 1 | Input used |
| Input  | Value   | Input used |       |       |            |         |   |            |         |  |            |         |  |            |         |  |            |         |  |            |         |   |            |         |   |            |         |   |            |         |   |            |         |   |            |          |   |            |          |   |            |          |   |            |          |   |            |          |   |            |          |   |            |
| Input 0  | 1   | Input used |       |       |            |         |   |            |         |  |            |         |  |            |         |  |            |         |  |            |         |   |            |         |   |            |         |   |            |         |   |            |         |   |            |          |   |            |          |   |            |          |   |            |          |   |            |          |   |            |          |   |            |
| Input 1  |   | Input used |       |       |            |         |   |            |         |  |            |         |  |            |         |  |            |         |  |            |         |   |            |         |   |            |         |   |            |         |   |            |         |   |            |          |   |            |          |   |            |          |   |            |          |   |            |          |   |            |          |   |            |
| Input 2  |   | Input used |       |       |            |         |   |            |         |  |            |         |  |            |         |  |            |         |  |            |         |   |            |         |   |            |         |   |            |         |   |            |         |   |            |          |   |            |          |   |            |          |   |            |          |   |            |          |   |            |          |   |            |
| Input 3  |   | Input used |       |       |            |         |   |            |         |  |            |         |  |            |         |  |            |         |  |            |         |   |            |         |   |            |         |   |            |         |   |            |         |   |            |          |   |            |          |   |            |          |   |            |          |   |            |          |   |            |          |   |            |
| Input 4  |   | Input used |       |       |            |         |   |            |         |  |            |         |  |            |         |  |            |         |  |            |         |   |            |         |   |            |         |   |            |         |   |            |         |   |            |          |   |            |          |   |            |          |   |            |          |   |            |          |   |            |          |   |            |
| Input 5  | 1   | Input used |       |       |            |         |   |            |         |  |            |         |  |            |         |  |            |         |  |            |         |   |            |         |   |            |         |   |            |         |   |            |         |   |            |          |   |            |          |   |            |          |   |            |          |   |            |          |   |            |          |   |            |
| Input 6  | 1   | Input used |       |       |            |         |   |            |         |  |            |         |  |            |         |  |            |         |  |            |         |   |            |         |   |            |         |   |            |         |   |            |         |   |            |          |   |            |          |   |            |          |   |            |          |   |            |          |   |            |          |   |            |
| Input 7  | 1   | Input used |       |       |            |         |   |            |         |  |            |         |  |            |         |  |            |         |  |            |         |   |            |         |   |            |         |   |            |         |   |            |         |   |            |          |   |            |          |   |            |          |   |            |          |   |            |          |   |            |          |   |            |
| Input 8  | 1   | Input used |       |       |            |         |   |            |         |  |            |         |  |            |         |  |            |         |  |            |         |   |            |         |   |            |         |   |            |         |   |            |         |   |            |          |   |            |          |   |            |          |   |            |          |   |            |          |   |            |          |   |            |
| Input 9  | 1   | Input used |       |       |            |         |   |            |         |  |            |         |  |            |         |  |            |         |  |            |         |   |            |         |   |            |         |   |            |         |   |            |         |   |            |          |   |            |          |   |            |          |   |            |          |   |            |          |   |            |          |   |            |
| Input 10   | 1   | Input used |       |       |            |         |   |            |         |  |            |         |  |            |         |  |            |         |  |            |         |   |            |         |   |            |         |   |            |         |   |            |         |   |            |          |   |            |          |   |            |          |   |            |          |   |            |          |   |            |          |   |            |
| Input 11   | 1   | Input used |       |       |            |         |   |            |         |  |            |         |  |            |         |  |            |         |  |            |         |   |            |         |   |            |         |   |            |         |   |            |         |   |            |          |   |            |          |   |            |          |   |            |          |   |            |          |   |            |          |   |            |
| Input 12   | 1   | Input used |       |       |            |         |   |            |         |  |            |         |  |            |         |  |            |         |  |            |         |   |            |         |   |            |         |   |            |         |   |            |         |   |            |          |   |            |          |   |            |          |   |            |          |   |            |          |   |            |          |   |            |
| Input 13   | 1   | Input used |       |       |            |         |   |            |         |  |            |         |  |            |         |  |            |         |  |            |         |   |            |         |   |            |         |   |            |         |   |            |         |   |            |          |   |            |          |   |            |          |   |            |          |   |            |          |   |            |          |   |            |
| Input 14   | 1   | Input used |       |       |            |         |   |            |         |  |            |         |  |            |         |  |            |         |  |            |         |   |            |         |   |            |         |   |            |         |   |            |         |   |            |          |   |            |          |   |            |          |   |            |          |   |            |          |   |            |          |   |            |
| Input 15   | 1   | Input used |       |       |            |         |   |            |         |  |            |         |  |            |         |  |            |         |  |            |         |   |            |         |   |            |         |   |            |         |   |            |         |   |            |          |   |            |          |   |            |          |   |            |          |   |            |          |   |            |          |   |            |
| <b>External Inputs</b>   |   | Dec        |       |       |            |         |   |            |         |  |            |         |  |            |         |  |            |         |  |            |         |   |            |         |   |            |         |   |            |         |   |            |         |   |            |          |   |            |          |   |            |          |   |            |          |   |            |          |   |            |          |   |            |
| SDI16 SDO4 and SDI16 Input0External - Input15External<br><br>SDI8 SDO2 Input0External - Input7External | <p>Deactivation of the evaluation of the module's own test pulses for the inputs, for sensors with own test pulse generation (OSSD) or without test pulse (OSSD) option. Selection via a drop-down list is possible depending on the configurator. If both inputs belonging to the test pulse output are set to "Input external", no more 24V are output on the test pulse output.</p>  |            |       |       |            |         |   |            |         |  |            |         |  |            |         |  |            |         |  |            |         |   |            |         |   |            |         |   |            |         |   |            |         |   |            |          |   |            |          |   |            |          |   |            |          |   |            |          |   |            |          |   |            |

| FSoE parameter   |   |   |   |                                |                    |   |                    |                    |                                |                    |                    |                             |                    |                          |  |                                 |                  |   |                    |                  |   |                    |                  |   |                    |                  |   |                    |                  |   |                    |                   |   |                    |                   |   |                    |                   |   |                    |                   |   |                    |                   |   |                    |                   |   |                    |  |
|--|---|---|---|--------------------------------|--------------------|---|--------------------|--------------------|--------------------------------|--------------------|--------------------|-----------------------------|--------------------|--------------------------|--|---------------------------------|------------------|---|--------------------|------------------|---|--------------------|------------------|---|--------------------|------------------|---|--------------------|------------------|---|--------------------|-------------------|---|--------------------|-------------------|---|--------------------|-------------------|---|--------------------|-------------------|---|--------------------|-------------------|---|--------------------|-------------------|---|--------------------|--|
| Parameter  |   | Unit  |   |                                |                    |   |                    |                    |                                |                    |                    |                             |                    |                          |  |                                 |                  |   |                    |                  |   |                    |                  |   |                    |                  |   |                    |                  |   |                    |                   |   |                    |                   |   |                    |                   |   |                    |                   |   |                    |                   |   |                    |                   |   |                    |  |
| Safety module Setting / range [Default]  | Description / note  |   |   |                                |                    |   |                    |                    |                                |                    |                    |                             |                    |                          |  |                                 |                  |   |                    |                  |   |                    |                  |   |                    |                  |   |                    |                  |   |                    |                   |   |                    |                   |   |                    |                   |   |                    |                   |   |                    |                   |   |                    |                   |   |                    |  |
|  | <table border="1"> <tr><td>Input 0 External</td><td>0</td><td>Input not external</td></tr> <tr><td>Input 1 External</td><td>Symbolic Value:<br/>Input not external</td><td>Input not external</td></tr> <tr><td>Input 2 External</td><td>Input not external</td><td>Input not external</td></tr> <tr><td>Input 3 External</td><td>Input external</td><td>Input not external</td></tr> <tr><td>Input 4 External</td><td></td><td>Input not external</td></tr> <tr><td>Input 5 External</td><td>0</td><td>Input not external</td></tr> <tr><td>Input 6 External</td><td>0</td><td>Input not external</td></tr> <tr><td>Input 7 External</td><td>0</td><td>Input not external</td></tr> <tr><td>Input 8 External</td><td>0</td><td>Input not external</td></tr> <tr><td>Input 9 External</td><td>0</td><td>Input not external</td></tr> <tr><td>Input 10 External</td><td>0</td><td>Input not external</td></tr> <tr><td>Input 11 External</td><td>0</td><td>Input not external</td></tr> <tr><td>Input 12 External</td><td>0</td><td>Input not external</td></tr> <tr><td>Input 13 External</td><td>0</td><td>Input not external</td></tr> <tr><td>Input 14 External</td><td>0</td><td>Input not external</td></tr> <tr><td>Input 15 External</td><td>0</td><td>Input not external</td></tr> </table> | Input 0 External  | 0 | Input not external             | Input 1 External   | Symbolic Value:<br>Input not external             | Input not external | Input 2 External   | Input not external             | Input not external | Input 3 External   | Input external              | Input not external | Input 4 External         |  | Input not external              | Input 5 External | 0 | Input not external | Input 6 External | 0 | Input not external | Input 7 External | 0 | Input not external | Input 8 External | 0 | Input not external | Input 9 External | 0 | Input not external | Input 10 External | 0 | Input not external | Input 11 External | 0 | Input not external | Input 12 External | 0 | Input not external | Input 13 External | 0 | Input not external | Input 14 External | 0 | Input not external | Input 15 External | 0 | Input not external |  |
| Input 0 External   | 0   | Input not external  |   |                                |                    |   |                    |                    |                                |                    |                    |                             |                    |                          |  |                                 |                  |   |                    |                  |   |                    |                  |   |                    |                  |   |                    |                  |   |                    |                   |   |                    |                   |   |                    |                   |   |                    |                   |   |                    |                   |   |                    |                   |   |                    |  |
| Input 1 External   | Symbolic Value:<br>Input not external   | Input not external  |   |                                |                    |   |                    |                    |                                |                    |                    |                             |                    |                          |  |                                 |                  |   |                    |                  |   |                    |                  |   |                    |                  |   |                    |                  |   |                    |                   |   |                    |                   |   |                    |                   |   |                    |                   |   |                    |                   |   |                    |                   |   |                    |  |
| Input 2 External   | Input not external  | Input not external  |   |                                |                    |   |                    |                    |                                |                    |                    |                             |                    |                          |  |                                 |                  |   |                    |                  |   |                    |                  |   |                    |                  |   |                    |                  |   |                    |                   |   |                    |                   |   |                    |                   |   |                    |                   |   |                    |                   |   |                    |                   |   |                    |  |
| Input 3 External   | Input external  | Input not external  |   |                                |                    |   |                    |                    |                                |                    |                    |                             |                    |                          |  |                                 |                  |   |                    |                  |   |                    |                  |   |                    |                  |   |                    |                  |   |                    |                   |   |                    |                   |   |                    |                   |   |                    |                   |   |                    |                   |   |                    |                   |   |                    |  |
| Input 4 External   |   | Input not external  |   |                                |                    |   |                    |                    |                                |                    |                    |                             |                    |                          |  |                                 |                  |   |                    |                  |   |                    |                  |   |                    |                  |   |                    |                  |   |                    |                   |   |                    |                   |   |                    |                   |   |                    |                   |   |                    |                   |   |                    |                   |   |                    |  |
| Input 5 External   | 0   | Input not external  |   |                                |                    |   |                    |                    |                                |                    |                    |                             |                    |                          |  |                                 |                  |   |                    |                  |   |                    |                  |   |                    |                  |   |                    |                  |   |                    |                   |   |                    |                   |   |                    |                   |   |                    |                   |   |                    |                   |   |                    |                   |   |                    |  |
| Input 6 External   | 0   | Input not external  |   |                                |                    |   |                    |                    |                                |                    |                    |                             |                    |                          |  |                                 |                  |   |                    |                  |   |                    |                  |   |                    |                  |   |                    |                  |   |                    |                   |   |                    |                   |   |                    |                   |   |                    |                   |   |                    |                   |   |                    |                   |   |                    |  |
| Input 7 External   | 0   | Input not external  |   |                                |                    |   |                    |                    |                                |                    |                    |                             |                    |                          |  |                                 |                  |   |                    |                  |   |                    |                  |   |                    |                  |   |                    |                  |   |                    |                   |   |                    |                   |   |                    |                   |   |                    |                   |   |                    |                   |   |                    |                   |   |                    |  |
| Input 8 External   | 0   | Input not external  |   |                                |                    |   |                    |                    |                                |                    |                    |                             |                    |                          |  |                                 |                  |   |                    |                  |   |                    |                  |   |                    |                  |   |                    |                  |   |                    |                   |   |                    |                   |   |                    |                   |   |                    |                   |   |                    |                   |   |                    |                   |   |                    |  |
| Input 9 External   | 0   | Input not external  |   |                                |                    |   |                    |                    |                                |                    |                    |                             |                    |                          |  |                                 |                  |   |                    |                  |   |                    |                  |   |                    |                  |   |                    |                  |   |                    |                   |   |                    |                   |   |                    |                   |   |                    |                   |   |                    |                   |   |                    |                   |   |                    |  |
| Input 10 External  | 0   | Input not external  |   |                                |                    |   |                    |                    |                                |                    |                    |                             |                    |                          |  |                                 |                  |   |                    |                  |   |                    |                  |   |                    |                  |   |                    |                  |   |                    |                   |   |                    |                   |   |                    |                   |   |                    |                   |   |                    |                   |   |                    |                   |   |                    |  |
| Input 11 External  | 0   | Input not external  |   |                                |                    |   |                    |                    |                                |                    |                    |                             |                    |                          |  |                                 |                  |   |                    |                  |   |                    |                  |   |                    |                  |   |                    |                  |   |                    |                   |   |                    |                   |   |                    |                   |   |                    |                   |   |                    |                   |   |                    |                   |   |                    |  |
| Input 12 External  | 0   | Input not external  |   |                                |                    |   |                    |                    |                                |                    |                    |                             |                    |                          |  |                                 |                  |   |                    |                  |   |                    |                  |   |                    |                  |   |                    |                  |   |                    |                   |   |                    |                   |   |                    |                   |   |                    |                   |   |                    |                   |   |                    |                   |   |                    |  |
| Input 13 External  | 0   | Input not external  |   |                                |                    |   |                    |                    |                                |                    |                    |                             |                    |                          |  |                                 |                  |   |                    |                  |   |                    |                  |   |                    |                  |   |                    |                  |   |                    |                   |   |                    |                   |   |                    |                   |   |                    |                   |   |                    |                   |   |                    |                   |   |                    |  |
| Input 14 External  | 0   | Input not external  |   |                                |                    |   |                    |                    |                                |                    |                    |                             |                    |                          |  |                                 |                  |   |                    |                  |   |                    |                  |   |                    |                  |   |                    |                  |   |                    |                   |   |                    |                   |   |                    |                   |   |                    |                   |   |                    |                   |   |                    |                   |   |                    |  |
| Input 15 External  | 0   | Input not external  |   |                                |                    |   |                    |                    |                                |                    |                    |                             |                    |                          |  |                                 |                  |   |                    |                  |   |                    |                  |   |                    |                  |   |                    |                  |   |                    |                   |   |                    |                   |   |                    |                   |   |                    |                   |   |                    |                   |   |                    |                   |   |                    |  |
| <b>usedOutputs</b>   |   | Dec   |   |                                |                    |   |                    |                    |                                |                    |                    |                             |                    |                          |  |                                 |                  |   |                    |                  |   |                    |                  |   |                    |                  |   |                    |                  |   |                    |                   |   |                    |                   |   |                    |                   |   |                    |                   |   |                    |                   |   |                    |                   |   |                    |  |
| SDI16/SDO4<br>Output0 - Output3  | Enables the outputs used. Selection from a drop-down list depends on the configurator.  |   |   |                                |                    |   |                    |                    |                                |                    |                    |                             |                    |                          |  |                                 |                  |   |                    |                  |   |                    |                  |   |                    |                  |   |                    |                  |   |                    |                   |   |                    |                   |   |                    |                   |   |                    |                   |   |                    |                   |   |                    |                   |   |                    |  |
| SDI8/SDO2<br>Output0 - Output1   | <table border="1"> <tr><td>Output 0</td><td>1</td><td>Output used</td></tr> <tr><td>Output 1</td><td>Symbolic Value:<br/>Output not used</td><td>Output used</td></tr> <tr><td>Output 2</td><td>Output not used</td><td>Output used</td></tr> <tr><td>Output 3</td><td>Output used</td><td>Output used</td></tr> <tr><td>Output 0 ExtGround</td><td></td><td>Output not used external ground</td></tr> </table>   | Output 0  | 1 | Output used                    | Output 1           | Symbolic Value:<br>Output not used                | Output used        | Output 2           | Output not used                | Output used        | Output 3           | Output used                 | Output used        | Output 0 ExtGround       |  | Output not used external ground |                  |   |                    |                  |   |                    |                  |   |                    |                  |   |                    |                  |   |                    |                   |   |                    |                   |   |                    |                   |   |                    |                   |   |                    |                   |   |                    |                   |   |                    |  |
| Output 0   | 1   | Output used   |   |                                |                    |   |                    |                    |                                |                    |                    |                             |                    |                          |  |                                 |                  |   |                    |                  |   |                    |                  |   |                    |                  |   |                    |                  |   |                    |                   |   |                    |                   |   |                    |                   |   |                    |                   |   |                    |                   |   |                    |                   |   |                    |  |
| Output 1   | Symbolic Value:<br>Output not used  | Output used   |   |                                |                    |   |                    |                    |                                |                    |                    |                             |                    |                          |  |                                 |                  |   |                    |                  |   |                    |                  |   |                    |                  |   |                    |                  |   |                    |                   |   |                    |                   |   |                    |                   |   |                    |                   |   |                    |                   |   |                    |                   |   |                    |  |
| Output 2   | Output not used   | Output used   |   |                                |                    |   |                    |                    |                                |                    |                    |                             |                    |                          |  |                                 |                  |   |                    |                  |   |                    |                  |   |                    |                  |   |                    |                  |   |                    |                   |   |                    |                   |   |                    |                   |   |                    |                   |   |                    |                   |   |                    |                   |   |                    |  |
| Output 3   | Output used   | Output used   |   |                                |                    |   |                    |                    |                                |                    |                    |                             |                    |                          |  |                                 |                  |   |                    |                  |   |                    |                  |   |                    |                  |   |                    |                  |   |                    |                   |   |                    |                   |   |                    |                   |   |                    |                   |   |                    |                   |   |                    |                   |   |                    |  |
| Output 0 ExtGround   |   | Output not used external ground   |   |                                |                    |   |                    |                    |                                |                    |                    |                             |                    |                          |  |                                 |                  |   |                    |                  |   |                    |                  |   |                    |                  |   |                    |                  |   |                    |                   |   |                    |                   |   |                    |                   |   |                    |                   |   |                    |                   |   |                    |                   |   |                    |  |
| <b>extGroundOutputs</b>  |   | Dec   |   |                                |                    |   |                    |                    |                                |                    |                    |                             |                    |                          |  |                                 |                  |   |                    |                  |   |                    |                  |   |                    |                  |   |                    |                  |   |                    |                   |   |                    |                   |   |                    |                   |   |                    |                   |   |                    |                   |   |                    |                   |   |                    |  |
| SDI16/SDO4<br>Output0ExtGround - Output3ExtGround  | Enable if the actuator is not connected to module terminal SO X- but uses an external ground connection. Selection from a drop-down list depends on the configurator.   |   |   |                                |                    |   |                    |                    |                                |                    |                    |                             |                    |                          |  |                                 |                  |   |                    |                  |   |                    |                  |   |                    |                  |   |                    |                  |   |                    |                   |   |                    |                   |   |                    |                   |   |                    |                   |   |                    |                   |   |                    |                   |   |                    |  |
| SDI8/SDO2<br>Output0ExtGround - Output1ExtGround   | <table border="1"> <tr><td>Output 0 ExtGround</td><td>0</td><td>Output without external ground</td></tr> <tr><td>Output 1 ExtGround</td><td>Symbolic Value:<br/>Output without external ground</td><td></td></tr> <tr><td>Output 2 ExtGround</td><td>Output without external ground</td><td></td></tr> <tr><td>Output 3 ExtGround</td><td>Output with external ground</td><td></td></tr> <tr><td>Input 0 filter time [µs]</td><td></td><td></td></tr> </table>  | Output 0 ExtGround  | 0 | Output without external ground | Output 1 ExtGround | Symbolic Value:<br>Output without external ground |                    | Output 2 ExtGround | Output without external ground |                    | Output 3 ExtGround | Output with external ground |                    | Input 0 filter time [µs] |  |                                 |                  |   |                    |                  |   |                    |                  |   |                    |                  |   |                    |                  |   |                    |                   |   |                    |                   |   |                    |                   |   |                    |                   |   |                    |                   |   |                    |                   |   |                    |  |
| Output 0 ExtGround   | 0   | Output without external ground  |   |                                |                    |   |                    |                    |                                |                    |                    |                             |                    |                          |  |                                 |                  |   |                    |                  |   |                    |                  |   |                    |                  |   |                    |                  |   |                    |                   |   |                    |                   |   |                    |                   |   |                    |                   |   |                    |                   |   |                    |                   |   |                    |  |
| Output 1 ExtGround   | Symbolic Value:<br>Output without external ground   |   |   |                                |                    |   |                    |                    |                                |                    |                    |                             |                    |                          |  |                                 |                  |   |                    |                  |   |                    |                  |   |                    |                  |   |                    |                  |   |                    |                   |   |                    |                   |   |                    |                   |   |                    |                   |   |                    |                   |   |                    |                   |   |                    |  |
| Output 2 ExtGround   | Output without external ground  |   |   |                                |                    |   |                    |                    |                                |                    |                    |                             |                    |                          |  |                                 |                  |   |                    |                  |   |                    |                  |   |                    |                  |   |                    |                  |   |                    |                   |   |                    |                   |   |                    |                   |   |                    |                   |   |                    |                   |   |                    |                   |   |                    |  |
| Output 3 ExtGround   | Output with external ground   |   |   |                                |                    |   |                    |                    |                                |                    |                    |                             |                    |                          |  |                                 |                  |   |                    |                  |   |                    |                  |   |                    |                  |   |                    |                  |   |                    |                   |   |                    |                   |   |                    |                   |   |                    |                   |   |                    |                   |   |                    |                   |   |                    |  |
| Input 0 filter time [µs]   |   |   |   |                                |                    |   |                    |                    |                                |                    |                    |                             |                    |                          |  |                                 |                  |   |                    |                  |   |                    |                  |   |                    |                  |   |                    |                  |   |                    |                   |   |                    |                   |   |                    |                   |   |                    |                   |   |                    |                   |   |                    |                   |   |                    |  |
| <b>Input x filter time [µs]</b>  |   | µs  |   |                                |                    |   |                    |                    |                                |                    |                    |                             |                    |                          |  |                                 |                  |   |                    |                  |   |                    |                  |   |                    |                  |   |                    |                  |   |                    |                   |   |                    |                   |   |                    |                   |   |                    |                   |   |                    |                   |   |                    |                   |   |                    |  |
| SDI16/SDO4 and SDI16<br>Input 0 filter time [µs] - Input 15 filter time [µs]<br>500 ... 1500<br>[1500] | Test pulse length of input x<br>Input filter of input x   |  |   |                                |                    |   |                    |                    |                                |                    |                    |                             |                    |                          |  |                                 |                  |   |                    |                  |   |                    |                  |   |                    |                  |   |                    |                  |   |                    |                   |   |                    |                   |   |                    |                   |   |                    |                   |   |                    |                   |   |                    |                   |   |                    |  |
| SDI8/SDO2<br>Input 0 filter time [µs] - Input 7 filter time [µs]<br>500 ... 1500                       | The digital test pulse output is interrupted for the set duration of every test pulse. The Kuhnke FIO Safety I/O module checks whether the digital inputs may turn Null and whether there are any short circuits to noise voltages on the signal line.<br>Adapt the test pulse duration to the peripherals you use.   |   |   |                                |                    |   |                    |                    |                                |                    |                    |                             |                    |                          |  |                                 |                  |   |                    |                  |   |                    |                  |   |                    |                  |   |                    |                  |   |                    |                   |   |                    |                   |   |                    |                   |   |                    |                   |   |                    |                   |   |                    |                   |   |                    |  |

| FSoE parameter  |   |   |                          |        |                                   |                          |                        |                                   |                          |        |                                   |                          |        |                                 |                          |        |                                 |                          |        |                                 |                          |        |                                 |                          |        |                                  |                          |        |                                  |                          |        |                                   |                           |        |                                   |                           |        |                                 |                           |        |        |                           |  |  |                           |  |  |                           |      |        |
|---|---|---|--------------------------|--------|-----------------------------------|--------------------------|------------------------|-----------------------------------|--------------------------|--------|-----------------------------------|--------------------------|--------|---------------------------------|--------------------------|--------|---------------------------------|--------------------------|--------|---------------------------------|--------------------------|--------|---------------------------------|--------------------------|--------|----------------------------------|--------------------------|--------|----------------------------------|--------------------------|--------|-----------------------------------|---------------------------|--------|-----------------------------------|---------------------------|--------|---------------------------------|---------------------------|--------|--------|---------------------------|--|--|---------------------------|--|--|---------------------------|------|--------|
| Parameter   |   | Unit  |                          |        |                                   |                          |                        |                                   |                          |        |                                   |                          |        |                                 |                          |        |                                 |                          |        |                                 |                          |        |                                 |                          |        |                                  |                          |        |                                  |                          |        |                                   |                           |        |                                   |                           |        |                                 |                           |        |        |                           |  |  |                           |  |  |                           |      |        |
| Safety module Setting / range [Default]   | Description / note  |   |                          |        |                                   |                          |                        |                                   |                          |        |                                   |                          |        |                                 |                          |        |                                 |                          |        |                                 |                          |        |                                 |                          |        |                                  |                          |        |                                  |                          |        |                                   |                           |        |                                   |                           |        |                                 |                           |        |        |                           |  |  |                           |  |  |                           |      |        |
| [1500]  | <table border="1"> <tr> <td>Input 0 filter time [us]</td> <td>1500</td> <td>1.5 ms</td> </tr> <tr> <td>Input 1 filter time [us]</td> <td><b>Symbolic Value:</b></td> <td>1.5 ms</td> </tr> <tr> <td>Input 2 filter time [us]</td> <td>0.5 ms</td> <td>1.5 ms</td> </tr> <tr> <td>Input 3 filter time [us]</td> <td>0.6 ms</td> <td>1.5 ms</td> </tr> <tr> <td>Input 4 filter time [us]</td> <td>0.7 ms</td> <td>1.5 ms</td> </tr> <tr> <td>Input 5 filter time [us]</td> <td>0.8 ms</td> <td>1.5 ms</td> </tr> <tr> <td>Input 6 filter time [us]</td> <td>0.9 ms</td> <td>1.5 ms</td> </tr> <tr> <td>Input 7 filter time [us]</td> <td>1.0 ms</td> <td>1.5 ms</td> </tr> <tr> <td>Input 8 filter time [us]</td> <td>1.1 ms</td> <td>1.5 ms</td> </tr> <tr> <td>Input 9 filter time [us]</td> <td>1.2 ms</td> <td>1.5 ms</td> </tr> <tr> <td>Input 10 filter time [us]</td> <td>1.3 ms</td> <td>1.5 ms</td> </tr> <tr> <td>Input 11 filter time [us]</td> <td>1.4 ms</td> <td>1.5 ms</td> </tr> <tr> <td>Input 12 filter time [us]</td> <td>1.5 ms</td> <td>1.5 ms</td> </tr> <tr> <td>Input 13 filter time [us]</td> <td></td> <td></td> </tr> <tr> <td>Input 14 filter time [us]</td> <td></td> <td></td> </tr> <tr> <td>Input 15 filter time [us]</td> <td>1500</td> <td>1.5 ms</td> </tr> </table> |   | Input 0 filter time [us] | 1500   | 1.5 ms                            | Input 1 filter time [us] | <b>Symbolic Value:</b> | 1.5 ms                            | Input 2 filter time [us] | 0.5 ms | 1.5 ms                            | Input 3 filter time [us] | 0.6 ms | 1.5 ms                          | Input 4 filter time [us] | 0.7 ms | 1.5 ms                          | Input 5 filter time [us] | 0.8 ms | 1.5 ms                          | Input 6 filter time [us] | 0.9 ms | 1.5 ms                          | Input 7 filter time [us] | 1.0 ms | 1.5 ms                           | Input 8 filter time [us] | 1.1 ms | 1.5 ms                           | Input 9 filter time [us] | 1.2 ms | 1.5 ms                            | Input 10 filter time [us] | 1.3 ms | 1.5 ms                            | Input 11 filter time [us] | 1.4 ms | 1.5 ms                          | Input 12 filter time [us] | 1.5 ms | 1.5 ms | Input 13 filter time [us] |  |  | Input 14 filter time [us] |  |  | Input 15 filter time [us] | 1500 | 1.5 ms |
| Input 0 filter time [us]  | 1500  | 1.5 ms  |                          |        |                                   |                          |                        |                                   |                          |        |                                   |                          |        |                                 |                          |        |                                 |                          |        |                                 |                          |        |                                 |                          |        |                                  |                          |        |                                  |                          |        |                                   |                           |        |                                   |                           |        |                                 |                           |        |        |                           |  |  |                           |  |  |                           |      |        |
| Input 1 filter time [us]  | <b>Symbolic Value:</b>  | 1.5 ms  |                          |        |                                   |                          |                        |                                   |                          |        |                                   |                          |        |                                 |                          |        |                                 |                          |        |                                 |                          |        |                                 |                          |        |                                  |                          |        |                                  |                          |        |                                   |                           |        |                                   |                           |        |                                 |                           |        |        |                           |  |  |                           |  |  |                           |      |        |
| Input 2 filter time [us]  | 0.5 ms  | 1.5 ms  |                          |        |                                   |                          |                        |                                   |                          |        |                                   |                          |        |                                 |                          |        |                                 |                          |        |                                 |                          |        |                                 |                          |        |                                  |                          |        |                                  |                          |        |                                   |                           |        |                                   |                           |        |                                 |                           |        |        |                           |  |  |                           |  |  |                           |      |        |
| Input 3 filter time [us]  | 0.6 ms  | 1.5 ms  |                          |        |                                   |                          |                        |                                   |                          |        |                                   |                          |        |                                 |                          |        |                                 |                          |        |                                 |                          |        |                                 |                          |        |                                  |                          |        |                                  |                          |        |                                   |                           |        |                                   |                           |        |                                 |                           |        |        |                           |  |  |                           |  |  |                           |      |        |
| Input 4 filter time [us]  | 0.7 ms  | 1.5 ms  |                          |        |                                   |                          |                        |                                   |                          |        |                                   |                          |        |                                 |                          |        |                                 |                          |        |                                 |                          |        |                                 |                          |        |                                  |                          |        |                                  |                          |        |                                   |                           |        |                                   |                           |        |                                 |                           |        |        |                           |  |  |                           |  |  |                           |      |        |
| Input 5 filter time [us]  | 0.8 ms  | 1.5 ms  |                          |        |                                   |                          |                        |                                   |                          |        |                                   |                          |        |                                 |                          |        |                                 |                          |        |                                 |                          |        |                                 |                          |        |                                  |                          |        |                                  |                          |        |                                   |                           |        |                                   |                           |        |                                 |                           |        |        |                           |  |  |                           |  |  |                           |      |        |
| Input 6 filter time [us]  | 0.9 ms  | 1.5 ms  |                          |        |                                   |                          |                        |                                   |                          |        |                                   |                          |        |                                 |                          |        |                                 |                          |        |                                 |                          |        |                                 |                          |        |                                  |                          |        |                                  |                          |        |                                   |                           |        |                                   |                           |        |                                 |                           |        |        |                           |  |  |                           |  |  |                           |      |        |
| Input 7 filter time [us]  | 1.0 ms  | 1.5 ms  |                          |        |                                   |                          |                        |                                   |                          |        |                                   |                          |        |                                 |                          |        |                                 |                          |        |                                 |                          |        |                                 |                          |        |                                  |                          |        |                                  |                          |        |                                   |                           |        |                                   |                           |        |                                 |                           |        |        |                           |  |  |                           |  |  |                           |      |        |
| Input 8 filter time [us]  | 1.1 ms  | 1.5 ms  |                          |        |                                   |                          |                        |                                   |                          |        |                                   |                          |        |                                 |                          |        |                                 |                          |        |                                 |                          |        |                                 |                          |        |                                  |                          |        |                                  |                          |        |                                   |                           |        |                                   |                           |        |                                 |                           |        |        |                           |  |  |                           |  |  |                           |      |        |
| Input 9 filter time [us]  | 1.2 ms  | 1.5 ms  |                          |        |                                   |                          |                        |                                   |                          |        |                                   |                          |        |                                 |                          |        |                                 |                          |        |                                 |                          |        |                                 |                          |        |                                  |                          |        |                                  |                          |        |                                   |                           |        |                                   |                           |        |                                 |                           |        |        |                           |  |  |                           |  |  |                           |      |        |
| Input 10 filter time [us]   | 1.3 ms  | 1.5 ms  |                          |        |                                   |                          |                        |                                   |                          |        |                                   |                          |        |                                 |                          |        |                                 |                          |        |                                 |                          |        |                                 |                          |        |                                  |                          |        |                                  |                          |        |                                   |                           |        |                                   |                           |        |                                 |                           |        |        |                           |  |  |                           |  |  |                           |      |        |
| Input 11 filter time [us]   | 1.4 ms  | 1.5 ms  |                          |        |                                   |                          |                        |                                   |                          |        |                                   |                          |        |                                 |                          |        |                                 |                          |        |                                 |                          |        |                                 |                          |        |                                  |                          |        |                                  |                          |        |                                   |                           |        |                                   |                           |        |                                 |                           |        |        |                           |  |  |                           |  |  |                           |      |        |
| Input 12 filter time [us]   | 1.5 ms  | 1.5 ms  |                          |        |                                   |                          |                        |                                   |                          |        |                                   |                          |        |                                 |                          |        |                                 |                          |        |                                 |                          |        |                                 |                          |        |                                  |                          |        |                                  |                          |        |                                   |                           |        |                                   |                           |        |                                 |                           |        |        |                           |  |  |                           |  |  |                           |      |        |
| Input 13 filter time [us]   |   |   |                          |        |                                   |                          |                        |                                   |                          |        |                                   |                          |        |                                 |                          |        |                                 |                          |        |                                 |                          |        |                                 |                          |        |                                  |                          |        |                                  |                          |        |                                   |                           |        |                                   |                           |        |                                 |                           |        |        |                           |  |  |                           |  |  |                           |      |        |
| Input 14 filter time [us]   |   |   |                          |        |                                   |                          |                        |                                   |                          |        |                                   |                          |        |                                 |                          |        |                                 |                          |        |                                 |                          |        |                                 |                          |        |                                  |                          |        |                                  |                          |        |                                   |                           |        |                                   |                           |        |                                 |                           |        |        |                           |  |  |                           |  |  |                           |      |        |
| Input 15 filter time [us]   | 1500  | 1.5 ms  |                          |        |                                   |                          |                        |                                   |                          |        |                                   |                          |        |                                 |                          |        |                                 |                          |        |                                 |                          |        |                                 |                          |        |                                  |                          |        |                                  |                          |        |                                   |                           |        |                                   |                           |        |                                 |                           |        |        |                           |  |  |                           |  |  |                           |      |        |
| <b>Test pulse duration output x</b>   |   | <b>µs</b>   |                          |        |                                   |                          |                        |                                   |                          |        |                                   |                          |        |                                 |                          |        |                                 |                          |        |                                 |                          |        |                                 |                          |        |                                  |                          |        |                                  |                          |        |                                   |                           |        |                                   |                           |        |                                 |                           |        |        |                           |  |  |                           |  |  |                           |      |        |
| SDI16/SDO4<br>Test pulse duration output0 - Test pulse duration output3<br>700 ... 1500<br>[1000] | Test pulse duration of output x   |  |                          |        |                                   |                          |                        |                                   |                          |        |                                   |                          |        |                                 |                          |        |                                 |                          |        |                                 |                          |        |                                 |                          |        |                                  |                          |        |                                  |                          |        |                                   |                           |        |                                   |                           |        |                                 |                           |        |        |                           |  |  |                           |  |  |                           |      |        |
| SDI8/SDO2<br>Test pulse duration output0 - Test pulse duration output1<br>700 ... 1500<br>[1000]  | <p>The digital test pulse output is interrupted for the set duration of every test pulse. The Kuhnke FIO Safety I/O module checks whether the digital outputs may turn Null and whether there are any short circuits to noise voltages on the signal line.</p> <p>Adapt the test pulse duration to the peripherals you use.</p>   |   |                          |        |                                   |                          |                        |                                   |                          |        |                                   |                          |        |                                 |                          |        |                                 |                          |        |                                 |                          |        |                                 |                          |        |                                  |                          |        |                                  |                          |        |                                   |                           |        |                                   |                           |        |                                 |                           |        |        |                           |  |  |                           |  |  |                           |      |        |
|   | <table border="1"> <tr> <td>Test pulse duration output 0 [us]</td> <td>1000</td> <td>1.0 ms</td> </tr> <tr> <td>Test pulse duration output 1 [us]</td> <td><b>Symbolic Value:</b></td> <td>1.0 ms</td> </tr> <tr> <td>Test pulse duration output 2 [us]</td> <td>0.7 ms</td> <td>1.0 ms</td> </tr> <tr> <td>Test pulse duration output 3 [us]</td> <td>0.8 ms</td> <td>1.0 ms</td> </tr> <tr> <td>Test frequency input 0 / 4 [Hz]</td> <td>0.9 ms</td> <td></td> </tr> <tr> <td>Test frequency input 1 / 5 [Hz]</td> <td>1.0 ms</td> <td></td> </tr> <tr> <td>Test frequency input 2 / 6 [Hz]</td> <td>1.1 ms</td> <td></td> </tr> <tr> <td>Test frequency input 3 / 7 [Hz]</td> <td>1.2 ms</td> <td></td> </tr> <tr> <td>Test frequency input 8 / 12 [Hz]</td> <td>1.3 ms</td> <td></td> </tr> <tr> <td>Test frequency input 9 / 13 [Hz]</td> <td>1.4 ms</td> <td></td> </tr> <tr> <td>Test frequency input 10 / 14 [Hz]</td> <td>1.5 ms</td> <td></td> </tr> <tr> <td>Test frequency input 11 / 15 [Hz]</td> <td></td> <td></td> </tr> <tr> <td>Test frequency output 0 [1/min]</td> <td></td> <td></td> </tr> </table>   | Test pulse duration output 0 [us]   | 1000                     | 1.0 ms | Test pulse duration output 1 [us] | <b>Symbolic Value:</b>   | 1.0 ms                 | Test pulse duration output 2 [us] | 0.7 ms                   | 1.0 ms | Test pulse duration output 3 [us] | 0.8 ms                   | 1.0 ms | Test frequency input 0 / 4 [Hz] | 0.9 ms                   |        | Test frequency input 1 / 5 [Hz] | 1.0 ms                   |        | Test frequency input 2 / 6 [Hz] | 1.1 ms                   |        | Test frequency input 3 / 7 [Hz] | 1.2 ms                   |        | Test frequency input 8 / 12 [Hz] | 1.3 ms                   |        | Test frequency input 9 / 13 [Hz] | 1.4 ms                   |        | Test frequency input 10 / 14 [Hz] | 1.5 ms                    |        | Test frequency input 11 / 15 [Hz] |                           |        | Test frequency output 0 [1/min] |                           |        |        |                           |  |  |                           |  |  |                           |      |        |
| Test pulse duration output 0 [us]   | 1000  | 1.0 ms  |                          |        |                                   |                          |                        |                                   |                          |        |                                   |                          |        |                                 |                          |        |                                 |                          |        |                                 |                          |        |                                 |                          |        |                                  |                          |        |                                  |                          |        |                                   |                           |        |                                   |                           |        |                                 |                           |        |        |                           |  |  |                           |  |  |                           |      |        |
| Test pulse duration output 1 [us]   | <b>Symbolic Value:</b>  | 1.0 ms  |                          |        |                                   |                          |                        |                                   |                          |        |                                   |                          |        |                                 |                          |        |                                 |                          |        |                                 |                          |        |                                 |                          |        |                                  |                          |        |                                  |                          |        |                                   |                           |        |                                   |                           |        |                                 |                           |        |        |                           |  |  |                           |  |  |                           |      |        |
| Test pulse duration output 2 [us]   | 0.7 ms  | 1.0 ms  |                          |        |                                   |                          |                        |                                   |                          |        |                                   |                          |        |                                 |                          |        |                                 |                          |        |                                 |                          |        |                                 |                          |        |                                  |                          |        |                                  |                          |        |                                   |                           |        |                                   |                           |        |                                 |                           |        |        |                           |  |  |                           |  |  |                           |      |        |
| Test pulse duration output 3 [us]   | 0.8 ms  | 1.0 ms  |                          |        |                                   |                          |                        |                                   |                          |        |                                   |                          |        |                                 |                          |        |                                 |                          |        |                                 |                          |        |                                 |                          |        |                                  |                          |        |                                  |                          |        |                                   |                           |        |                                   |                           |        |                                 |                           |        |        |                           |  |  |                           |  |  |                           |      |        |
| Test frequency input 0 / 4 [Hz]   | 0.9 ms  |   |                          |        |                                   |                          |                        |                                   |                          |        |                                   |                          |        |                                 |                          |        |                                 |                          |        |                                 |                          |        |                                 |                          |        |                                  |                          |        |                                  |                          |        |                                   |                           |        |                                   |                           |        |                                 |                           |        |        |                           |  |  |                           |  |  |                           |      |        |
| Test frequency input 1 / 5 [Hz]   | 1.0 ms  |   |                          |        |                                   |                          |                        |                                   |                          |        |                                   |                          |        |                                 |                          |        |                                 |                          |        |                                 |                          |        |                                 |                          |        |                                  |                          |        |                                  |                          |        |                                   |                           |        |                                   |                           |        |                                 |                           |        |        |                           |  |  |                           |  |  |                           |      |        |
| Test frequency input 2 / 6 [Hz]   | 1.1 ms  |   |                          |        |                                   |                          |                        |                                   |                          |        |                                   |                          |        |                                 |                          |        |                                 |                          |        |                                 |                          |        |                                 |                          |        |                                  |                          |        |                                  |                          |        |                                   |                           |        |                                   |                           |        |                                 |                           |        |        |                           |  |  |                           |  |  |                           |      |        |
| Test frequency input 3 / 7 [Hz]   | 1.2 ms  |   |                          |        |                                   |                          |                        |                                   |                          |        |                                   |                          |        |                                 |                          |        |                                 |                          |        |                                 |                          |        |                                 |                          |        |                                  |                          |        |                                  |                          |        |                                   |                           |        |                                   |                           |        |                                 |                           |        |        |                           |  |  |                           |  |  |                           |      |        |
| Test frequency input 8 / 12 [Hz]  | 1.3 ms  |   |                          |        |                                   |                          |                        |                                   |                          |        |                                   |                          |        |                                 |                          |        |                                 |                          |        |                                 |                          |        |                                 |                          |        |                                  |                          |        |                                  |                          |        |                                   |                           |        |                                   |                           |        |                                 |                           |        |        |                           |  |  |                           |  |  |                           |      |        |
| Test frequency input 9 / 13 [Hz]  | 1.4 ms  |   |                          |        |                                   |                          |                        |                                   |                          |        |                                   |                          |        |                                 |                          |        |                                 |                          |        |                                 |                          |        |                                 |                          |        |                                  |                          |        |                                  |                          |        |                                   |                           |        |                                   |                           |        |                                 |                           |        |        |                           |  |  |                           |  |  |                           |      |        |
| Test frequency input 10 / 14 [Hz]   | 1.5 ms  |   |                          |        |                                   |                          |                        |                                   |                          |        |                                   |                          |        |                                 |                          |        |                                 |                          |        |                                 |                          |        |                                 |                          |        |                                  |                          |        |                                  |                          |        |                                   |                           |        |                                   |                           |        |                                 |                           |        |        |                           |  |  |                           |  |  |                           |      |        |
| Test frequency input 11 / 15 [Hz]   |   |   |                          |        |                                   |                          |                        |                                   |                          |        |                                   |                          |        |                                 |                          |        |                                 |                          |        |                                 |                          |        |                                 |                          |        |                                  |                          |        |                                  |                          |        |                                   |                           |        |                                   |                           |        |                                 |                           |        |        |                           |  |  |                           |  |  |                           |      |        |
| Test frequency output 0 [1/min]   |   |   |                          |        |                                   |                          |                        |                                   |                          |        |                                   |                          |        |                                 |                          |        |                                 |                          |        |                                 |                          |        |                                 |                          |        |                                  |                          |        |                                  |                          |        |                                   |                           |        |                                   |                           |        |                                 |                           |        |        |                           |  |  |                           |  |  |                           |      |        |
| <b>Test frequency input x</b>   |   | <b>Hz</b>   |                          |        |                                   |                          |                        |                                   |                          |        |                                   |                          |        |                                 |                          |        |                                 |                          |        |                                 |                          |        |                                 |                          |        |                                  |                          |        |                                  |                          |        |                                   |                           |        |                                   |                           |        |                                 |                           |        |        |                           |  |  |                           |  |  |                           |      |        |
| SDI16/SDO4 and SDI16<br>Test frequency input 0/4 - Test frequency input 11/15<br>1 ... 25<br>[25] | Test pulse frequency of input x   |  |                          |        |                                   |                          |                        |                                   |                          |        |                                   |                          |        |                                 |                          |        |                                 |                          |        |                                 |                          |        |                                 |                          |        |                                  |                          |        |                                  |                          |        |                                   |                           |        |                                   |                           |        |                                 |                           |        |        |                           |  |  |                           |  |  |                           |      |        |

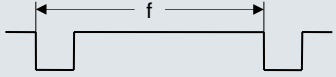
| FSoE parameter  |   |  |    |                                 |                 |                                 |                        |                                 |    |                                  |              |                                  |  |                                   |    |                                   |    |  |             |  |  |             |  |  |             |  |  |             |  |  |             |  |  |             |
|---|---|--|----|---------------------------------|-----------------|---------------------------------|------------------------|---------------------------------|----|----------------------------------|--------------|----------------------------------|--|-----------------------------------|----|-----------------------------------|----|--|-------------|--|--|-------------|--|--|-------------|--|--|-------------|--|--|-------------|--|--|-------------|
| Parameter   | Unit  |  |    |                                 |                 |                                 |                        |                                 |    |                                  |              |                                  |  |                                   |    |                                   |    |  |             |  |  |             |  |  |             |  |  |             |  |  |             |  |  |             |
| Safety module Setting / range [Default]   | Description / note  |  |    |                                 |                 |                                 |                        |                                 |    |                                  |              |                                  |  |                                   |    |                                   |    |  |             |  |  |             |  |  |             |  |  |             |  |  |             |  |  |             |
| SDI8/SDO2<br>Test frequency input 0/4 -<br>Test frequency input 3/7<br>1 ... 25<br>[25] | <table border="1"> <tr><td>Test frequency input 0 / 4 [Hz]</td><td>25</td></tr> <tr><td>Test frequency input 1 / 5 [Hz]</td><td>25</td></tr> <tr><td>Test frequency input 2 / 6 [Hz]</td><td>25</td></tr> <tr><td>Test frequency input 3 / 7 [Hz]</td><td>25</td></tr> <tr><td>Test frequency input 8 / 12 [Hz]</td><td>25</td></tr> <tr><td>Test frequency input 9 / 13 [Hz]</td><td>25</td></tr> <tr><td>Test frequency input 10 / 14 [Hz]</td><td>25</td></tr> <tr><td>Test frequency input 11 / 15 [Hz]</td><td>25</td></tr> </table>   | Test frequency input 0 / 4 [Hz]                    | 25 | Test frequency input 1 / 5 [Hz] | 25              | Test frequency input 2 / 6 [Hz] | 25                     | Test frequency input 3 / 7 [Hz] | 25 | Test frequency input 8 / 12 [Hz] | 25           | Test frequency input 9 / 13 [Hz] | 25   | Test frequency input 10 / 14 [Hz] | 25 | Test frequency input 11 / 15 [Hz] | 25 |  |             |  |  |             |  |  |             |  |  |             |  |  |             |  |  |             |
| Test frequency input 0 / 4 [Hz]   | 25  |  |    |                                 |                 |                                 |                        |                                 |    |                                  |              |                                  |  |                                   |    |                                   |    |  |             |  |  |             |  |  |             |  |  |             |  |  |             |  |  |             |
| Test frequency input 1 / 5 [Hz]   | 25  |  |    |                                 |                 |                                 |                        |                                 |    |                                  |              |                                  |  |                                   |    |                                   |    |  |             |  |  |             |  |  |             |  |  |             |  |  |             |  |  |             |
| Test frequency input 2 / 6 [Hz]   | 25  |  |    |                                 |                 |                                 |                        |                                 |    |                                  |              |                                  |  |                                   |    |                                   |    |  |             |  |  |             |  |  |             |  |  |             |  |  |             |  |  |             |
| Test frequency input 3 / 7 [Hz]   | 25  |  |    |                                 |                 |                                 |                        |                                 |    |                                  |              |                                  |  |                                   |    |                                   |    |  |             |  |  |             |  |  |             |  |  |             |  |  |             |  |  |             |
| Test frequency input 8 / 12 [Hz]  | 25  |  |    |                                 |                 |                                 |                        |                                 |    |                                  |              |                                  |  |                                   |    |                                   |    |  |             |  |  |             |  |  |             |  |  |             |  |  |             |  |  |             |
| Test frequency input 9 / 13 [Hz]  | 25  |  |    |                                 |                 |                                 |                        |                                 |    |                                  |              |                                  |  |                                   |    |                                   |    |  |             |  |  |             |  |  |             |  |  |             |  |  |             |  |  |             |
| Test frequency input 10 / 14 [Hz]   | 25  |  |    |                                 |                 |                                 |                        |                                 |    |                                  |              |                                  |  |                                   |    |                                   |    |  |             |  |  |             |  |  |             |  |  |             |  |  |             |  |  |             |
| Test frequency input 11 / 15 [Hz]   | 25  |  |    |                                 |                 |                                 |                        |                                 |    |                                  |              |                                  |  |                                   |    |                                   |    |  |             |  |  |             |  |  |             |  |  |             |  |  |             |  |  |             |
| <b>Test frequency output x</b>  | min-1   |  |    |                                 |                 |                                 |                        |                                 |    |                                  |              |                                  |  |                                   |    |                                   |    |  |             |  |  |             |  |  |             |  |  |             |  |  |             |  |  |             |
| SDI16/SDO4<br>Test frequency output 0 -<br>Test frequency output 3<br>1 ... 25<br>[10]  | <p>Test pulse frequency of output x</p>  <table border="1"> <tr><td>Test frequency output 0 [1/min]</td><td>10</td></tr> <tr><td>Test frequency output 1 [1/min]</td><td>10</td></tr> <tr><td>Test frequency output 2 [1/min]</td><td>10</td></tr> <tr><td>Test frequency output 3 [1/min]</td><td>10</td></tr> </table>   | Test frequency output 0 [1/min]                    | 10 | Test frequency output 1 [1/min] | 10              | Test frequency output 2 [1/min] | 10                     | Test frequency output 3 [1/min] | 10 |                                  |              |                                  |  |                                   |    |                                   |    |  |             |  |  |             |  |  |             |  |  |             |  |  |             |  |  |             |
| Test frequency output 0 [1/min]   | 10  |  |    |                                 |                 |                                 |                        |                                 |    |                                  |              |                                  |  |                                   |    |                                   |    |  |             |  |  |             |  |  |             |  |  |             |  |  |             |  |  |             |
| Test frequency output 1 [1/min]   | 10  |  |    |                                 |                 |                                 |                        |                                 |    |                                  |              |                                  |  |                                   |    |                                   |    |  |             |  |  |             |  |  |             |  |  |             |  |  |             |  |  |             |
| Test frequency output 2 [1/min]   | 10  |  |    |                                 |                 |                                 |                        |                                 |    |                                  |              |                                  |  |                                   |    |                                   |    |  |             |  |  |             |  |  |             |  |  |             |  |  |             |  |  |             |
| Test frequency output 3 [1/min]   | 10  |  |    |                                 |                 |                                 |                        |                                 |    |                                  |              |                                  |  |                                   |    |                                   |    |  |             |  |  |             |  |  |             |  |  |             |  |  |             |  |  |             |
| SDI8/SDO2<br>Test frequency output 0 -<br>Test frequency output 1<br>1 ... 25<br>[10]   |   |  |    |                                 |                 |                                 |                        |                                 |    |                                  |              |                                  |  |                                   |    |                                   |    |  |             |  |  |             |  |  |             |  |  |             |  |  |             |  |  |             |
| <b>Safety Mat x</b>   | Dec   |  |    |                                 |                 |                                 |                        |                                 |    |                                  |              |                                  |  |                                   |    |                                   |    |  |             |  |  |             |  |  |             |  |  |             |  |  |             |  |  |             |
| SDI16/SDO4 and SDI16<br>Safety Mat 0 - Safety Mat 3<br>0 ... 1<br>[0]                   | <p>Safety mat modes (safety mat / bumper)</p> <table border="1"> <tr><td>Safety Mat 0</td><td>0</td><td>none</td></tr> <tr><td>Safety Mat 1</td><td></td><td><b>Symbolic Value:</b></td></tr> <tr><td>Safety Mat 2</td><td></td><td>none</td></tr> <tr><td>Safety Mat 3</td><td></td><td>used (connect to in 0,1; conf. in 4,5 as external)</td></tr> <tr><td>Rotary Switch 0</td><td></td><td></td></tr> </table> <p>If the safety mat function is used, be sure to set all parameter inputs to InputxExternal.<br/>If Safety Mat 0 is used, SI0 (FSoE_Input 0), SI1 (FSoE_Input 1) and test pulse outputs SI0/4 TP and SI1/5 TP are used for the modes.<br/>Inputs SI4 (FSoE_Input 4) and SI5 (FSoE_Input 5) must then be set to and used as External, i.e. for sensors with their own or without OSSD signals.</p> | Safety Mat 0                                       | 0  | none                            | Safety Mat 1    |                                 | <b>Symbolic Value:</b> | Safety Mat 2                    |    | none                             | Safety Mat 3 |                                  | used (connect to in 0,1; conf. in 4,5 as external) | Rotary Switch 0                   |    |                                   |    |  |             |  |  |             |  |  |             |  |  |             |  |  |             |  |  |             |
| Safety Mat 0  | 0   | none   |    |                                 |                 |                                 |                        |                                 |    |                                  |              |                                  |  |                                   |    |                                   |    |  |             |  |  |             |  |  |             |  |  |             |  |  |             |  |  |             |
| Safety Mat 1  |   | <b>Symbolic Value:</b>                             |    |                                 |                 |                                 |                        |                                 |    |                                  |              |                                  |  |                                   |    |                                   |    |  |             |  |  |             |  |  |             |  |  |             |  |  |             |  |  |             |
| Safety Mat 2  |   | none   |    |                                 |                 |                                 |                        |                                 |    |                                  |              |                                  |  |                                   |    |                                   |    |  |             |  |  |             |  |  |             |  |  |             |  |  |             |  |  |             |
| Safety Mat 3  |   | used (connect to in 0,1; conf. in 4,5 as external) |    |                                 |                 |                                 |                        |                                 |    |                                  |              |                                  |  |                                   |    |                                   |    |  |             |  |  |             |  |  |             |  |  |             |  |  |             |  |  |             |
| Rotary Switch 0   |   |  |    |                                 |                 |                                 |                        |                                 |    |                                  |              |                                  |  |                                   |    |                                   |    |  |             |  |  |             |  |  |             |  |  |             |  |  |             |  |  |             |
| SDI8/SDO2<br>Safety Mat 0 - Safety Mat 1<br>0 ... 1<br>[0]                              |   |  |    |                                 |                 |                                 |                        |                                 |    |                                  |              |                                  |  |                                   |    |                                   |    |  |             |  |  |             |  |  |             |  |  |             |  |  |             |  |  |             |
| <b>Rotary Switch x</b>  | Dec   |  |    |                                 |                 |                                 |                        |                                 |    |                                  |              |                                  |  |                                   |    |                                   |    |  |             |  |  |             |  |  |             |  |  |             |  |  |             |  |  |             |
| SDI16/SDO4 and SDI16<br>Rotary Switch 0 – Rotary<br>Switch 1<br>0 ... 8<br>[0]          | <p>Rotary Switch Modes (mode selector)</p> <table border="1"> <tr><td>Rotary Switch 0</td><td>0</td><td>none</td></tr> <tr><td>Rotary Switch 1</td><td></td><td><b>Symbolic Value:</b></td></tr> <tr><td>Device Info</td><td></td><td>none</td></tr> <tr><td>Creator Info</td><td></td><td></td></tr> <tr><td></td><td></td><td>2 Positions</td></tr> <tr><td></td><td></td><td>3 Positions</td></tr> <tr><td></td><td></td><td>4 Positions</td></tr> <tr><td></td><td></td><td>5 Positions</td></tr> <tr><td></td><td></td><td>6 Positions</td></tr> <tr><td></td><td></td><td>7 Positions</td></tr> <tr><td></td><td></td><td>8 Positions</td></tr> </table>  | Rotary Switch 0                                    | 0  | none                            | Rotary Switch 1 |                                 | <b>Symbolic Value:</b> | Device Info                     |    | none                             | Creator Info |                                  |  |                                   |    | 2 Positions                       |    |  | 3 Positions |  |  | 4 Positions |  |  | 5 Positions |  |  | 6 Positions |  |  | 7 Positions |  |  | 8 Positions |
| Rotary Switch 0   | 0   | none   |    |                                 |                 |                                 |                        |                                 |    |                                  |              |                                  |  |                                   |    |                                   |    |  |             |  |  |             |  |  |             |  |  |             |  |  |             |  |  |             |
| Rotary Switch 1   |   | <b>Symbolic Value:</b>                             |    |                                 |                 |                                 |                        |                                 |    |                                  |              |                                  |  |                                   |    |                                   |    |  |             |  |  |             |  |  |             |  |  |             |  |  |             |  |  |             |
| Device Info   |   | none   |    |                                 |                 |                                 |                        |                                 |    |                                  |              |                                  |  |                                   |    |                                   |    |  |             |  |  |             |  |  |             |  |  |             |  |  |             |  |  |             |
| Creator Info  |   |  |    |                                 |                 |                                 |                        |                                 |    |                                  |              |                                  |  |                                   |    |                                   |    |  |             |  |  |             |  |  |             |  |  |             |  |  |             |  |  |             |
|   |   | 2 Positions  |    |                                 |                 |                                 |                        |                                 |    |                                  |              |                                  |  |                                   |    |                                   |    |  |             |  |  |             |  |  |             |  |  |             |  |  |             |  |  |             |
|   |   | 3 Positions  |    |                                 |                 |                                 |                        |                                 |    |                                  |              |                                  |  |                                   |    |                                   |    |  |             |  |  |             |  |  |             |  |  |             |  |  |             |  |  |             |
|   |   | 4 Positions  |    |                                 |                 |                                 |                        |                                 |    |                                  |              |                                  |  |                                   |    |                                   |    |  |             |  |  |             |  |  |             |  |  |             |  |  |             |  |  |             |
|   |   | 5 Positions  |    |                                 |                 |                                 |                        |                                 |    |                                  |              |                                  |  |                                   |    |                                   |    |  |             |  |  |             |  |  |             |  |  |             |  |  |             |  |  |             |
|   |   | 6 Positions  |    |                                 |                 |                                 |                        |                                 |    |                                  |              |                                  |  |                                   |    |                                   |    |  |             |  |  |             |  |  |             |  |  |             |  |  |             |  |  |             |
|   |   | 7 Positions  |    |                                 |                 |                                 |                        |                                 |    |                                  |              |                                  |  |                                   |    |                                   |    |  |             |  |  |             |  |  |             |  |  |             |  |  |             |  |  |             |
|   |   | 8 Positions  |    |                                 |                 |                                 |                        |                                 |    |                                  |              |                                  |  |                                   |    |                                   |    |  |             |  |  |             |  |  |             |  |  |             |  |  |             |  |  |             |
| SDI8/SDO2<br>Rotary Switch 0<br>0 ... 8<br>[0]  |   |  |    |                                 |                 |                                 |                        |                                 |    |                                  |              |                                  |  |                                   |    |                                   |    |  |             |  |  |             |  |  |             |  |  |             |  |  |             |  |  |             |

| FSoE parameter                                |  |
|---|--|
| Parameter                                     | Unit   |
| Safety module<br>Setting / range<br>[Default] | Description / note   |
|   | Rotary Switch mode supports mode selectors with up to eight positions. In this case, test pulse output SI0/4 TP is used for Rotary Switch 0 and all switch positions and test pulse output SI8/12 TP for Rotary Switch1. |

### 6.4.3 Input Parameters

#### Parameters "Used Inputs" and "External Inputs"

|   |  |
|---|--|
|  | <b>CAUTION</b>   |
|   | <p><b>Setting the Test Pulse Rate</b></p> <p><i>In single-channel applications (inputs same as outputs), adapt the test pulse frequency to the application. In applications with frequent changes of state, the test pulse frequency should be at least 100x higher than the time of change of application state.</i></p> <p><i>In single-channel applications, the error response time of the inputs should be 3x the test pulse interval (25 Hz = 120 ms).</i></p> <p>Refer to section 6.4.2 FSoE Parameters</p> |

Use these parameters to enable the inputs of the Kuhnke FIO Safety I/O module and to select the input function. Use parameter "External Inputs" to disable the module's test pulse outputs that deliver test pulses to each of the inputs. Use this setting for sensors generating their own test pulses (some light barriers, for example).

|   |  |
|---|--|
|  | <b>WARNING</b>   |
|   | <p><b>Non-detection of a corrupt external wiring when test pulse outputs are disabled</b></p> <p><i>Unsafe machine state, safety hazard</i></p> <ul style="list-style-type: none"> <li>• Always use the correct and enabled test pulse output to supply power to contact-type sensors.</li> <li>• Note: Consider protecting the cables and/or laying them separately to ensure a sufficient degree of safety.</li> </ul> |

In mode selector mode "Mode Selector", you may connect 2 to 8 inputs of test pulse output SI0/4 TP to a mode selector (test pulse output SI8/12 TP for Rotary Switch 1). Disable the test pulse outputs you do not need. Refer to manual section →7.4 Mode Selector for a wiring example. Inputs you do not use and the associated test pulse outputs can be used for other functions.

#### Parameter "Input filter time"

If used together with the module's test pulse outputs, test pulses cyclically check the input circuit connected to the Kuhnke FIO Safety I/O module for faults such as short circuits or internal defects. In this case, the test pulse duration is preset to 1.5 ms and cannot be modified by a parameter.

Use parameter "Input x filter time" to set the filter time of the digital inputs in case you are working with external safety sensors. You may have to modify the test pulse duration if the signals are affected by capacitive properties of the input circuit, for example. In this case, the inputs have a preset filter of 1000 µs. The configurable part from 500 µs to 1500 µs will be added to this value.

Note: The sum total of the fixed and the set filter time will affect the module's failover time. Refer to section 4.8 Response Time

### Parameter "Test frequency input"

If used together with the module's test pulse outputs, test pulses cyclically check the input circuit connected to the Kuhnke FIO Safety I/O module for faults such as short circuits or internal defects. Parameter "Test pulse duration input" sets the switching frequency and, thus, the frequency of test pulses allocated to a digital test pulse output.

|   |   |
|---|---|
|  | <b>WARNING</b>  |
|   | <p><b><i>Non-detection of a corrupt external wiring when test pulse outputs are disabled</i></b><br/> <i>Unsafe machine state, safety hazard</i></p> <ul style="list-style-type: none"> <li>• Always use the correct and enabled test pulse output to supply power to contact-type sensors.</li> <li>• Note: Consider protecting the cables and/or laying them separately to ensure a sufficient degree of safety.</li> </ul> |

### 6.4.4 Output Parameters

|   |   |
|---|---|
|  | <b>CAUTION</b>  |
|   | <p><b><i>Setting the Test Pulse Rate</i></b><br/> <i>In single-channel applications (inputs same as outputs), adapt the test pulse frequency to the application. In applications with frequent changes of state, the test pulse frequency should be at least 100x higher than the time of change of application state.</i><br/> <i>In single-channel applications, the error response time of the inputs should be 3x the test pulse interval (25 Hz = 120 ms).</i><br/> Refer to section 6.4.2 FSoE Parameters</p> |

### Parameter "Outputs external Ground"

Enable if the sensor is not connected to module terminal SO X- but uses an external ground connection. Pick from a drop-down list provided by the configurator software. Linking the sensor to an external ground connection instead of terminal SO X- disallows you to control an external 24 VDC power supply.

Also set this parameter if output SO X+ supplies an electronic load such as a digital input of an I/O module.

### Parameter "Used Outputs"

Enables the outputs used.

Pick from a drop-down list

### Parameter "Test pulse duration output"

Test pulses cyclically check the digital outputs of the Kuhnke FIO Safety I/O module for faults such as short circuits or internal defects. Parameter "Test pulse duration output" sets the time of a test pulse allocated to a digital output. If you connect a capacitive load to the digital power output, you may have to modify the test pulse duration.

|   |  |
|---|--|
|  | <b><i>Note, information</i></b>  |
|   | <p><b><i>Test pulses to the outputs</i></b><br/> Match the connected loads and the test pulse duration setting such that the test pulses are prevented from switching the loads.</p> |

## Parameter "Test frequency output"

Test pulses cyclically test the digital outputs of the Kuhnke FIO Safety I/O module. Parameter "Test frequency output" sets the switching frequency and, thus, the frequency of test pulses allocated to a digital output. Adapt this parameter to real-life conditions particularly when using inductive or capacitive loads.

|  |  |
|--|--|
|  | <b>WARNING</b>   |
|  | <p><b><i>Non-detection of incorrect external wiring while test pulses are disabled</i></b><br/> <i>Unsafe machine state, safety hazard</i></p> <ul style="list-style-type: none"> <li>• Use the output test pulses to detect cross-faults at the outputs and other faults.</li> <li>• Note: Consider protecting the cables and/or laying them separately to ensure a sufficient degree of safety.</li> <li>• You are strictly advised against turning off the test pulses because this reduce the safety of the application.</li> </ul>        |
|  | <b>WARNING</b>   |
|  | <p><b><i>Reduced diagnosis if the test pulses at the outputs are deactivated</i></b><br/> <i>You are strictly advised against turning off the test pulses because this reduce the safety of the application. If you turn off the test pulses at the outputs, ensure that the outputs are still diagnosed by:</i></p> <p><i>Setting the outputs once a year and making sure that they are switched by a function (of the application) or by completely shutting the device down and restarting it.</i></p>                                      |
|  | <b>CAUTION</b>   |
|  | <p><b><i>Shut-off of test pulses to the output</i></b><br/> <i>Owing to the construction of the outputs, shutting off the test pulses to an output channel will not stop test pulses from being generated at that output if test pulses are still set for the other output channel. Frequency and length of these test pulses are determined by the other output. Verify that these test pulses cannot switch the actuators connected.</i></p> <p>To stop the generation of test pulses, you must disable the test pulses to both outputs.</p> |
|  | <b>CAUTION</b>   |
|  | <p><b><i>Minimum length of test pulses</i></b><br/> <i>Owing to the construction of the outputs, different test pulse length settings of the two output channels will generate test pulses of the minimum length set for both outputs of both channels. Verify that both outputs comply with this minimum value to ensure that all test pulses are of a minimum length. Verify that this minimum test pulse length cannot switch the actuators connected.</i></p>  |

## 6.5 Putting into Service

|  |   |
|--|---|
|  | <b>ATTENTION</b>  |
|  | <p><b><i>The safety-related products may be used by the following persons only.</i></b></p> <ul style="list-style-type: none"> <li>• Qualified persons who know the applicable concepts of functional safety as well as the relevant standards and regulations.</li> <li>• Qualified persons who plan, design, install and put machine and system safety equipment into operation.</li> </ul> |



### Note, information

#### Usage note

Kuhnke's FIO Safety I/O module may be used ETG-compliant configurations with conforming products. Such products include slave services, master and development systems, and functional safety products. Check the products for the "EtherCAT Conformance Tested" logo to see if they have passed an official test for conformity. Certified products are listed in the EtherCAT Product Guide published by the EtherCAT Technology Group.

## Topology of CODESYS devices

Like in all other CODESYS projects, the project environment of safety projects must identically reflect the hardware topology. You can either set up the topology manually or, provided that all device descriptions have been installed, start a search for devices in CODESYS. Right-click on the EtherCAT master and pick "Geräte suchen..." (Find devices) from the context menu. In the next dialog, you just need to confirm to "Alle Geräte ins Projekt kopieren" (Copy all devices to project).

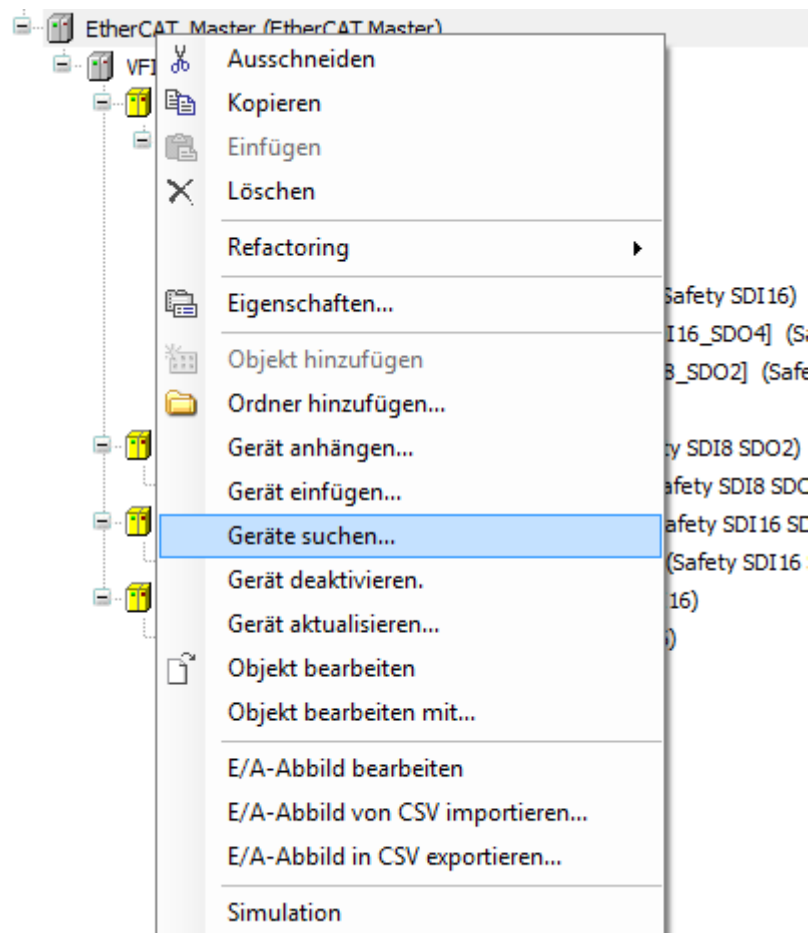

CODESYS configuration example:



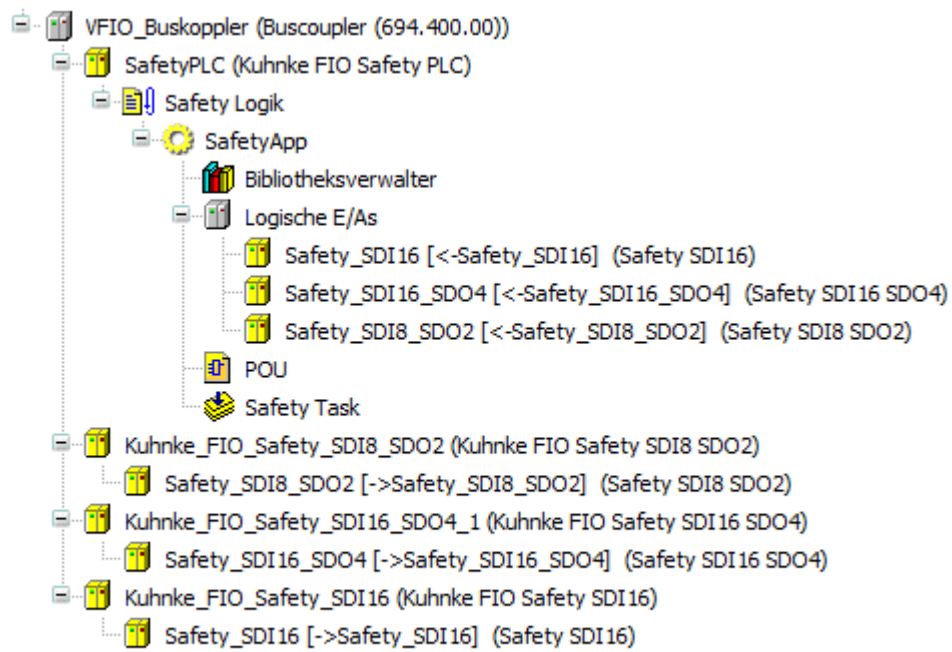

Refer to the manual of your PLC to know how to set up a CODESYS project.

## 6.6 Diagnosis

### 6.6.1 Self-test

When system voltage is supplied to the Kuhnke Safety module, it initially runs a complete system test. Only if this system test is passed will the module be able to operate and first of all change to its "fail-safe" state.

This is indicated by LED "Safe Status" lighting up red.

The FIO Safety I/O module will retain the fail-safe state until all internal tests have been passed, valid data has been received from the control unit, and faults are not detected in any of the external hardware, sensors, actuators and their wiring.

A safe functional state is indicated by LED "Safe Status" lighting up green.

The module will retain its fail-safe state if it fails to qualify for the safe state, e.g. because of errors in the application's module setup. To find the cause of the problem, check the error code in the service block → 6.6.6 Table of Faults.

In service, the system test is repeated cyclically as a background process.

To repeat the initial system test, just turn the power supply off and back on again.

### 6.6.2 Kuhnke FIO Safety I/O Module Faults

The cyclic system test will duly detect all faults in the module within the minimum safe failover time specified in section Technical Data in conformity with the requirements of the standards listed in the certificate. The module will change to its fail-safe state.

This is indicated by LED "Safe Status" lighting up red.

|  |   |
|--|---|
|  | <b>DANGER</b>   |
|  | <p><b><i>Use of devices in a fail-safe state</i></b></p> <p><i>The following faults may provoke a hazard</i></p> <p>Whenever a fault occurs, initiate all the required repairs or replacements.</p> |

### 6.6.3 Wrong Wiring

Wiring faults such as

- a cross-fault between the inputs,
- external power supplied to the inputs,
- wrong test pulse output allocation to a specific input,
- external power supplied to the outputs, or
- a cross-fault between the outputs,
- wrong allocation of SOX+ to the associated SOX- connector of the outputs,
- a short at the outputs

will change the Kuhnke FIO Safety I/O module to its safe state. The red Diagnosis LED of the affected channel lights up.

Error messages may also be provoked by badly adjusted loads. Please refer to sections 4.5.4 Safe Digital Outputs and 6.3.9 Actuator Connection.

### 6.6.4 Temperature Faults

|   |  |
|---|--|
|  | <b>CAUTION</b>   |
|   | <p><b><i>Do not operate the FIO Safety I/O module out of the specified range</i></b></p> <p><i>Faults due to overloading of components due to over- or undertemperature</i></p> <p>Operate the module under the ambient conditions listed in section Technical Data only while observing the derating of the outputs – see section 6.3.10.</p> |

The module is designed for ambient temperatures between 0 °C and max. 55 °C and for being installed in a control cabinet. The FIO Safety I/O module features an extra internal temperature sensor. Excess temperature will change the module to its safe state. You cannot start the module at temperatures below 0 °C.

### 6.6.5 Wrong Supply Voltage

The supply voltage is rated at 24 VDC. It is monitored. In case of overvoltage (> +27.5%) and low voltage (< -25%) alike, the module changes to its safe state.

Power to the logic circuitry of the safe I/O modules is drawn from the 5 V of the backplane bus. The safe I/O modules monitor the 5 V supply to the logical circuit and change to the safe state when there is not enough voltage (< 4.55 V) for sustained operation.

### 6.6.6 Table of Faults

Depending on their type, faults detected are indicated by the diagnosis LEDs of the Kuhnke FIO Safety I/O module and made available as a diagnostic message in error register object 1001<sub>h</sub>. Diagnostic messages help you identify the fault and to take the required corrective actions.

The tables below list and describe the faults, their causes, effects and corrective actions.

Whenever a fault occurs, you should first of all remove its cause and acknowledge the fault in the error register according to instructions.

| Table of Faults   |   |  |
|---|---|--|
| Fault   | Possible Cause  | Corrective Action  |
| <b>Module fails to start, inputs are not read.</b>                                      | Wrong FSoE address set at the binary switch   | <ul style="list-style-type: none"> <li>• Check address setting at the module</li> <li>• Check address selected in the safety PLC</li> <li>• Check module for mechanical damage and replace as necessary</li> </ul>   |
| <b>Inputs still enabled although outputs are in safe state<br/>Inputs still enabled</b> | FSoE slave address changed in service<br>System power supply interrupted<br>System power supply too low                   | <ul style="list-style-type: none"> <li>• Check error code in the service block</li> <li>• Do not change the address coding switch in service</li> <li>• Check module for mechanical damage and replace as necessary</li> <li>• Check supply voltage</li> </ul> |
| <b>Module is in safe state, diagnosis LEDs of the inputs light up red</b>               | Wrong wiring, e.g. test pulse signals swapped<br>Cross-fault between the inputs<br>External power supplied to the outputs | <ul style="list-style-type: none"> <li>• Check error code in the service block</li> <li>• Check module wiring</li> </ul>   |
| <b>Module is in safe state, one diagnosis LED at the output lights up red</b>           | Overload on an output<br>Cross-fault at an output<br>External power supplied to an output                                 | <ul style="list-style-type: none"> <li>• Check error code in the service block</li> <li>• Check module wiring</li> <li>• Check the output current of the output</li> </ul>   |
| <b>Module is in safe state, LED "Safe Status" lights up red</b>                         | EtherCAT connection interrupted<br>Internal module fault  | <ul style="list-style-type: none"> <li>• Check wiring of the EtherCAT fieldbus cables</li> <li>• Check that FIO modules interconnect properly</li> </ul>   |
| <b>Module is in safe state, LED "Safe Status" lights up red</b>                         | I/O power is low  | <ul style="list-style-type: none"> <li>• Check I/O power</li> <li>• Check wiring</li> </ul>  |

## 6.6.7 Error Codes

| Error codes (object dictionary 0x2007 or 0x2017 - Err.code) |  |   |
|---|--|---|
| Error Code (hex)  | Cause  | Comment   |
| Effect  | Corrective Action  |   |
| <b>0x0001</b>   | <b>Internal software error</b>                             | Internal module monitoring has detected an error. Inputs and outputs change to the safe state, FSoE communication stops.  |
| Module in safe state  |  | <ul style="list-style-type: none"> <li>Module RESET by turning the system power off and back on again – self-test repeats.</li> <li>Replace module if error prevails</li> </ul>                     |
| <b>0x0002</b>   | <b>Internal hardware fault</b>                             | Internal module monitoring has detected a hardware fault. Inputs and outputs change to the safe state, FSoE communication stops.  |
| Module in safe state  |  | <ul style="list-style-type: none"> <li>Module RESET by turning the system power off and back on again – self-test repeats.</li> <li>Replace module if error prevails</li> </ul>                     |
| <b>0x0243</b>   | <b>Low voltage</b>   | Voltage supplied to the module is below the admissible range. Inputs and outputs change to the safe state, FSoE communication stops.  |
| Module in safe state  |  | <ul style="list-style-type: none"> <li>Check actual system power supplied</li> <li>Check length and stress on the feed line</li> </ul>  |
| <b>e.g.:<br/>0x0F50</b>                                     | <b>Parameter error</b>                                     | Module fails to change to its functional state.   |
| Module in safe state  |  | <ul style="list-style-type: none"> <li>Check module parameter setup</li> <li>Use parameter settings in the admissible range only</li> </ul>   |
| <b>e.g.:<br/>0x0630</b>                                     | <b>Cross-fault at or external power supplied to input</b>  | Cross-fault to another input or test pulse output or external power supplied; red diagnosis LED of affected channel lights up.<br>Inputs and outputs turn "0" at the module and in the process map. |
| Module in safe state  |  | <ul style="list-style-type: none"> <li>Check sensor</li> <li>Check test pulse outputs</li> <li>Check connector and wiring</li> </ul>  |
| <b>e.g.:<br/>0x0660</b>                                     | <b>Short circuit or overload</b>                           | Short circuit in the output wiring or wrong output load, red diagnosis LED of affected channel lights up  |
| Module in safe state  |  | <ul style="list-style-type: none"> <li>Check actuator</li> <li>Check connector and wiring</li> <li>Check free wheel wiring at contactor</li> </ul>  |
| <b>e.g.:<br/>0x0670</b>                                     | <b>Cross-fault at or external power supplied to output</b> | Cross-fault to another output or another signal; red diagnosis LED of affected channel lights up  |
| Module in safe state  |  | <ul style="list-style-type: none"> <li>Check actuator</li> <li>Check connector and wiring</li> </ul>  |



### Note, information

For a detailed description of the entry in object 2007<sub>h</sub> or 2017<sub>h</sub> "Err.code", refer to the table in section 8.1.13.

## 6.6.8 EtherCAT Link Lost

All modules change to their fail-safe state when the EtherCAT link is lost or interrupted. Once the fault has been removed, an Error Acknowledge is enough to restart the EtherCAT bus.

### 6.6.9 Wrong FSoE Address

A wrong FSoE address causes the affected modules to retain their fail-safe state. The fault is detected by the master and cannot be acknowledged.

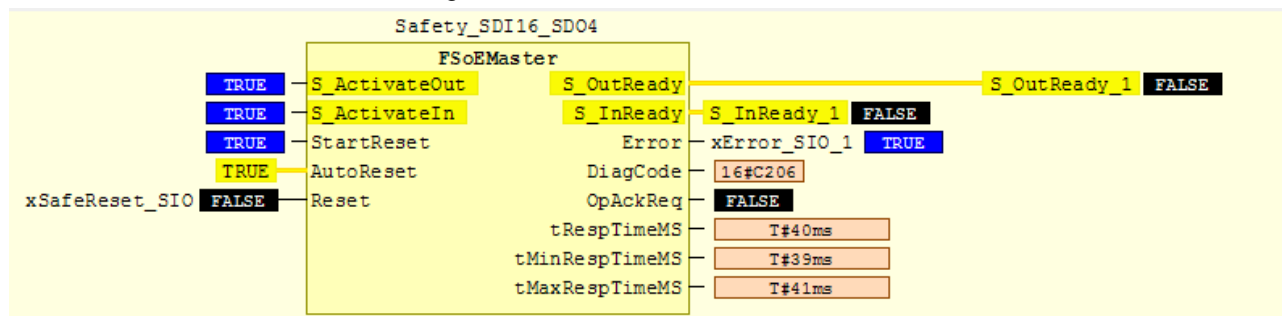

Table 28 – FSoE communication error codes

| Error Code | Description  |
|------------|--|
| 0          | Local reset or acknowledgement of a RESET command            |
| 1          | Unexpected command (INVALID_CMD)                             |
| 2          | Unknown command (UNKNOWN_CMD)                                |
| 3          | Invalid connection ID (INVALID_CONNID)                       |
| 4          | CRC error (INVALID_CRC)                                      |
| 5          | Watchdog has expired (WD_EXPIRED)                            |
| 6          | Invalid FSoE Slave Address (INVALID_ADDRESS)                 |
| 7          | Invalid safety data (INVALID_DATA)                           |
| 8          | Invalid communication parameter length (INVALID_COMMPARALEN) |
| 9          | Invalid communication parameter data (INVALID_COMPARA)       |
| 10         | Invalid application parameter length (INVALID_USERPARALEN)   |
| 11         | Invalid application parameter data (INVALID_USERPARA)        |
| 0x80-0xFF  | Invalid SafePara (device-specific)                           |

Once all FSoE addresses are correct, the safety modules will restart normal operation after one power cycle.

### 6.6.10 Wrong configuration of the Kuhnke FIO Safety module

By design, safety control units prevent configuration errors from provoking dangerous states. Therefore, after downloading a safety project with a bad configuration, all safety module are in a fail-safe state. The master shows the incorrect configuration.

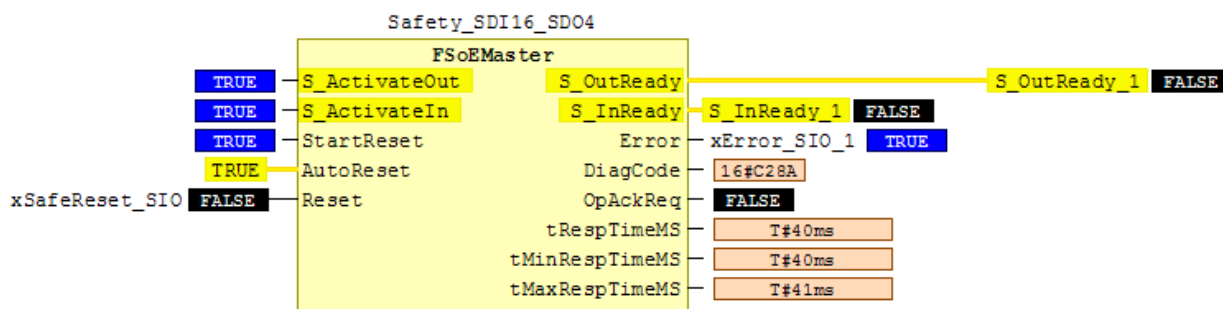

To restart the safety modules, first remove the incorrect configuration, then download the project again and finally Acknowledge the error<sup>2</sup>.

## 6.7 Reset / Acknowledge Error

The error class decides whether and how an error can be acknowledged, see section → 8.1.16 .Err.class 200Ah

<sup>2</sup> Provided that there are no faults

| Error Class | Explanation   | Acknowledged / Reset by |
|-------------|---|-------------------------|
| 0           | No error  | Not required            |
| 1           | Internal, communication, synchronisation, parameter, TP, FB error | PowerCycle              |
| 2           | Error in Test Handler (BIST)                                      | PowerCycle              |
| 3           | External, I/O Error   | Error Acknowledge       |

**PowerCycle:**

After removing the cause of the error, you can reset the Kuhnke FIO Safety module by a power cycle (PowerCycle -> turn off and back on) provided that the automatic self-test is passed.

**Error Acknowledge:**

Input or output errors can be reset by the safety PLC.

|   |   |
|---|---|
|  | <b>WARNING</b>  |
|   | <p><b>Reset / acknowledge may cause a dangerous state</b></p> <p><i>Apart from the exceptions specified, acknowledging an error will immediately restore the safe output to its normal state of operation.</i></p> <ul style="list-style-type: none"> <li>• Before acknowledging an error, verify that its cause has been removed professionally.</li> <li>• Before acknowledging an error, verify that acknowledging it will not cause a dangerous machine state.</li> <li>• At the machine or system planning stage, make sure that acknowledging an error must not be possible unless you have full view of the danger zone.</li> <li>• Ensure a safe restart if necessary.</li> </ul> |

## 6.8 Maintenance / Servicing

### 6.8.1 General

Only qualified persons are allowed to work on FIO Safety.

|   |   |
|---|---|
|  | <b>CAUTION</b>  |
|   | <p><b>Unsafe and undefined machine state</b></p> <p><i>Destruction or malfunction</i></p> <ul style="list-style-type: none"> <li>• Do not plug, mount, unplug or touch the connectors during operation!</li> <li>• Turn off all power sources before working on the modules. This also applies to any peripherals connected such as encoders, programming devices with external power source, etc.</li> <li>• Check that none of the ventilation slots is covered.</li> </ul> |

### 6.8.2 Servicing

FIO Safety requires neither servicing for the specified service life nor any action if it is kept and operated at the admissible ambient conditions specified in section Technical Data.

### 6.8.3 Preventive Maintenance

Prevent inadmissible contamination while operating and storing FIO Safety. Do not use or continue to use the Kuhnke FIO Safety I/O module in case it has been exposed to inadmissible contamination.

|   |  |
|---|--|
|  | <b>CAUTION</b>   |
|   | <p><b>Unsafe and undefined machine state</b><br/> <i>Risk of injury</i></p> <p>You are not allowed to operate an inadmissibly contaminated module. Neither is cleaning the unit allowed.</p> |

## 6.9 Replacing a Kuhnke FIO Safety I/O Module

When you replace a Kuhnke FIO Safety I/O module, its configuration is retained and transferred to the new module when you restart the system. The programming environment will tell you if the new module is incompatible. You must carry out appropriate tests to verify whether there are any other failure modes such as using the wrong terminals or making wiring mistakes.

The text below describes how to replace a Kuhnke FIO Safety I/O module with a Kuhnke FIO Safety I/O module of the same type.

|   |  |
|---|--|
|  | <b>CAUTION</b>   |
|   | <p><b>Unsafe and undefined machine state</b><br/> <i>Risk of injury</i></p> <ul style="list-style-type: none"> <li>• Turn off the power supply of the control unit and the FIO modules before replacing a Kuhnke FIO Safety I/O module.</li> <li>• After you have replaced any Kuhnke FIO Safety I/O modules, separately test the safety function before you restart the machine or system.</li> <li>• Design your wiring tests such that you will reliably discover the use of a wrong terminal.</li> </ul> |

|   |  |
|---|--|
|  | <b>NOTE</b>  |
|   | <p><i>You must set up your entire project again if you replace a Kuhnke FIO Safety I/O module with a module of another type. If so, refer to the user guide of the new module.</i></p> |

### Procedure

- Verify that the new module meets the following requirements:
  - Same type of device
  - Same or higher version, see section → 5.1 Labelling and Identification
- Enable the safe system or machine state.
- Turn off the power supply of the control unit and the FIO modules.
- To remove the old module see sections →
- Disconnecting Two Modules and 6.2.6 Taking Down a Single Module:
  - Dissolve the line of FIO modules by pressing the unlock button of the module to be separated from the module to its left and sliding both modules about 1 cm apart.
  - Push the module up and against the metal spring located on the underside of the rail guide.
  - Tip the module away from the rail as shown in the illustration.
  - Pull the module down and out of the mounting rail.
- Locate the FSoE address at the address coding switch of the module you are replacing and transfer that address to the new module → 6.4.1 Address Setup

- Install the new module at the same place within the line of FIO modules as one you just removed (→ 6.2.3 Snapping on a Single Module).
- Plug the inline connectors to the correct ports.

### Restart

- Verify that the machine or system is in a safe state and that there is nothing and nobody in the danger zone.
- Turn the supply voltage back on.
- Start the new safety module as if you initially operate a module → 6.5 Putting into Service
  - The configuration of the old module has been retained and will be transferred to the new module when you restart the system.
- Check all safety functions after replacing a module.

## 6.10 Durability

Kuhnke FIO Safety I/O modules have a design life of max. 20 years after the date of manufacture (see 5.1.2 Serial Number ) by Kendrion Kuhnke Automation GmbH. Take the module out of service at the end of its useful life → 6.10.3 Taking out of Service.

### 6.10.1 Repairs / Customer Service

You are not allowed to open or try to repair a FIO Safety I/O module.

Doing so will void the warranty.

|   |  |
|---|--|
|  | <b>Note, information</b>   |
|   | <p><b><i>In case of a potentially hazardous failure</i></b></p> <p><i>In case a module failure is potentially hazardous, return the module to the manufacturer where the fault will be identified.</i></p> <p>The manufacturer's address is printed on the Kuhnke FIO Safety I/O module and in manual section → 9.1.1 Malente Headquarters</p> |

### 6.10.2 Warranty

The statutory period and conditions of warranty apply. Warranty expires if unauthorised attempts are made to repair the unit / product or any other intervention is performed see section 2.1.4 Warranty.

### 6.10.3 Taking out of Service

The manufacturer of the machine or system specifies the procedure of taking the product out of service. The process must fully comply with the specified procedure.

Make sure that the modules of the Kuhnke FIO Safety system you are taking out of service are provided for further use as intended. Refer to section Technical Data for detailed transport and storage requirements.

### 6.10.4 Disposal

Dispose of the Kuhnke FIO Safety system in conformity with the applicable environmental regulations and make sure that it is not returned into circulation.

Treat the packaging as recyclable paper and cardboard.



## 7 Connection Examples

This section describes examples of applications that make use of the Kuhnke FIO Safety I/O module functions to provide a safety function. It also describes the resulting safety ratings.

|   |  |
|---|--|
|  | <b>CAUTION</b>   |
|   | <p><b><i>Using the examples described in this section is not enough to obtain the safety function needed to reduce the risk as established in the risk assessment (SIL/Cat./PL).</i></b></p> <p><i>Personal injury and damage to property</i></p> <ul style="list-style-type: none"> <li>• Choose suitable and approved sensors (e.g. to EN 60947-5-1 / -5.) and make sure that your switching devices have the appropriate B10d value.</li> <li>• You may have to take further actions to obtain the safety function when using the system together with safe devices, sensor and actuators (e.g. reading the relay contact signals). Refer to the user guide of your safe devices for further details.</li> <li>• Configure your Kuhnke FIO Safety I/O module with reference to the actual environment.</li> </ul> |

The safety ratings listed for the examples below solely apply to the part of the safety function covered by the safe I/O module. Please note that the safety ratings below only apply if the test pulses are enabled.

|   |   |
|---|---|
|  | <b>WARNING</b>  |
|   | <p><b><i>Non-detection of a corrupt external wiring when test pulse outputs are disabled</i></b></p> <p><i>Unsafe machine state, safety hazard</i></p> <ul style="list-style-type: none"> <li>• Always use the correct and enabled test pulse output to supply power to contact-type sensors.</li> <li>• Note: Consider protecting the cables and/or laying them separately to ensure a sufficient degree of safety.</li> </ul> |

## 7.1 Safety Function with Single-channel Input

|  |                       |
|--|-----------------------|
|   | <p><b>CAUTION</b></p> |
| <p><b>Setting the Test Pulse Rate</b></p> <p><i>In single-channel applications (inputs same as outputs), adapt the test pulse frequency to the application. In applications with frequent changes of state, the test pulse frequency should be at least 100x higher than the time of change of application state.</i></p> <p><i>In single-channel applications, the error response time of the inputs should be 3x the test pulse interval (25 Hz = 120 ms).</i></p> <p>Refer to section FSoE Parameters 6.4.2</p> |                       |

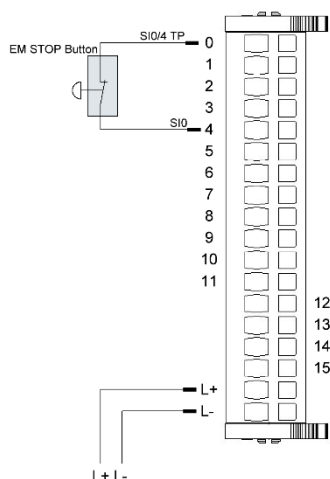

You may connect contact-type sensors such as emergency stop buttons straight to a safe digital input.

Every test pulse output is allocated to two safe inputs, see section 6.3.8 Sensor Connection. This test pulse output supplies a specific signal you may use to detect wiring problems such as a short circuit to 24 VDC, GND or other signal channels. The state of connected switches is indicated by LEDs allocated to the channels (see section → 5.4 Indicators and Controls).

Whenever an emergency stop button is pressed, the safety PLC will generate a stop signal. Resetting the emergency stop device must not be enough to initiate a restart signal.

### Safety ratings of single-channel sensors

The safety ratings listed in the table below reflect the maximum values a single-channel safety function may achieve when using a single input of the safe I/O module. They solely apply to the part of the safety function covered by the safe I/O module. All components involved in the safety function must be taken into account in order to assess whether the desired safety ratings are achieved. The quality of the safe sensor is of crucial importance with particular regard to the safety function of analysing a single-channel sensor. Use approved sensors only (e.g. to EN 60947-5-1 / -5.) and take account of your switching device's B10d value. The safety assessment of the safety function must also consider the safety ratings of the safe PLC used in the application.

| Safety ratings when applying the module's test pulses to single-channel contact-type sensors |   |
|--|---|
| Highest safety integrity level to EN 62061:2010  | SIL2  |
| Highest safety integrity level to IEC 61508:2010   | SIL2  |
| Category and highest performance level to EN ISO 13849-1:2015                                | Cat. 2/PL d   |
| Hardware fault tolerance (HFT) in single-channel application (IEC 61508:2010/EN)             | 0<br>(a fault of the application may cause the safeguard to fail) |

## 7.2 Safety Function with Two-channel Input

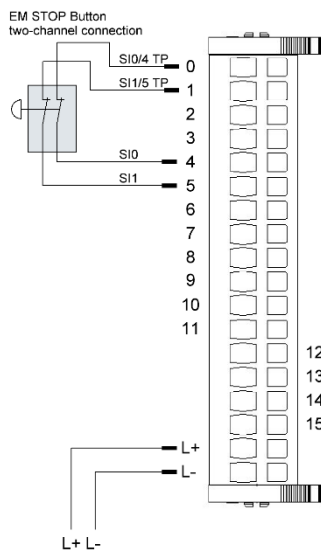

For applications requiring single-fault safety such as EMERGENCY OFF, EMERGENCY STOP, you may connect two digital inputs to two switching devices of safe sensors and further to the safety module.

A software module of the safety PLC provides the required analysis of the switching contacts.

**"FB\_ESTOP"** is a safety-related component intended to monitor an EMERGENCY STOP button. FB\_ESTOP can be used for both the emergency switch off function (stop category 0) or – with the assistance of additional peripherals - the EMERGENCY STOP function (stop categories 1 or 2).

FB\_ESTOP can be used to monitor single and two-channel EMERGENCY STOP switches. The component's discrepancy time monitoring is enabled for two-channel applications.

**Discrepancy time monitoring:** The discrepancy time defines as the maximum length of time both inputs may be in different states without the component interpreting this as a fault. Discrepancy time monitoring starts whenever the state of one input changes. The components will detect a fault if, at the end of the discrepancy time, both inputs are in different states.

fault if, at the end of the discrepancy time, both inputs are in different states.

### Safety ratings of two-channel sensors

The safety ratings listed in the table below reflect the maximum values a two-channel safety function may achieve when using two inputs of the safe I/O module. They solely apply to the part of the safety function covered by the safe I/O module. All components involved in the safety function must be taken into account in order to assess whether the desired safety ratings are achieved. The quality of the safe sensor is of crucial importance with particular regard to the safety function of analysing a two-channel sensor. Use approved sensors only (e.g. to EN 60947-5-1 / -5.) and take account of your switching device's B10d value. The safety assessment of the safety function must also consider the safety ratings of the safe PLC used in the application.

#### Safety ratings when applying the module's test pulses to two-channel contact-type sensors

|   |  |
|---|--|
| Highest safety integrity level to EN 62061:2010                               | SIL3   |
| Highest safety integrity level to IEC 61508:2010                              | SIL3   |
| Category and highest performance level to EN ISO 13849-1:2015                 | Cat. 4/PL e  |
| Hardware fault tolerance (HFT) in two-channel application (IEC 61508:2010/EN) | 1<br>(a fault of the application need not cause the safeguard to fail) |

### 7.3 Two-hand Actuation

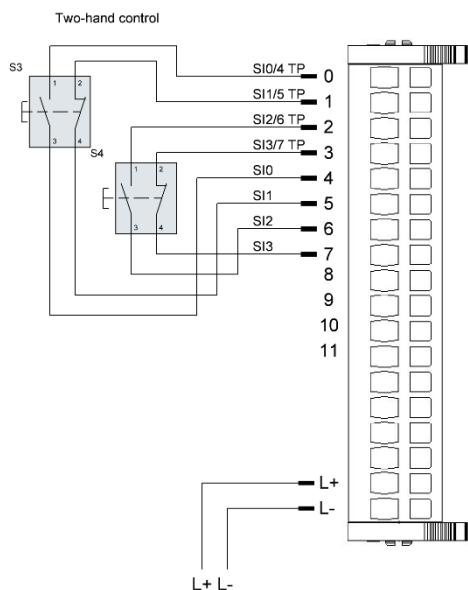

Two contact-type sensors can be connected to four safe digital inputs.

A software module of the safety PLC provides the analysis required for two-hand operation.

#### Two-hand circuit type 2

Software component " **FB\_TWOHAND\_TYP2**" supports function "two-hand circuit type 2" in conformity with European Standard EN 574. If S1 and S2 are set to TRUE in the correct order, bTwoHandOut will also become TRUE. The component also checks that both buttons have been released before setting output bTwoHandOut to TRUE again.

#### Two-hand circuit type 3

Software component " **FB\_TWOHAND\_TYP3**" supports function "two-hand circuit type 3" in conformity with the European Standard. If S1 and S2 are set to TRUE in the correct order and within 500 ms, bTwoHandOut will also become TRUE. The component also checks that both buttons have been released before setting output S\_TwoHandOut to

TRUE again.

### Safety ratings of two-channel sensors

The safety ratings listed in the table below reflect the maximum values a two-channel safety function may achieve when using four inputs of the safe I/O module. They solely apply to the part of the safety function covered by the safe I/O module. All components involved in the safety function must be taken into account in order to assess whether the desired safety ratings are achieved. The quality of the safe sensor is of crucial importance with particular regard to the safety function of analysing a two-hand operation. Use approved sensors only (e.g. to EN 60947-5-1 / -5.) and take account of your switching device's B10d value. The safety assessment of the safety function must also consider the safety ratings of the safe PLC used in the application.

| Safety ratings for function two-hand operation                                |  |
|---|--|
| Highest safety integrity level to EN 62061:2010                               | SIL3   |
| Highest safety integrity level to IEC 61508:2010                              | SIL3   |
| Category and highest performance level to EN ISO 13849-1:2015                 | Cat. 4/PL e  |
| Hardware fault tolerance (HFT) in two-channel application (IEC 61508:2010/EN) | 1<br>(a fault of the application need not cause the safeguard to fail) |

|  |  |
|--|--|
|  | <b>CAUTION</b>   |
|  | <p><b>Safety hazard due to wrong handling of the two-hand circuit</b></p> <ul style="list-style-type: none"> <li>Comply with EN 574 and other requirements and standards published on two-hand circuits.</li> <li>Switches/sensors, wiring and application must comply with EN 574.</li> </ul> |

## 7.4 Mode Selector, Rotary Switch

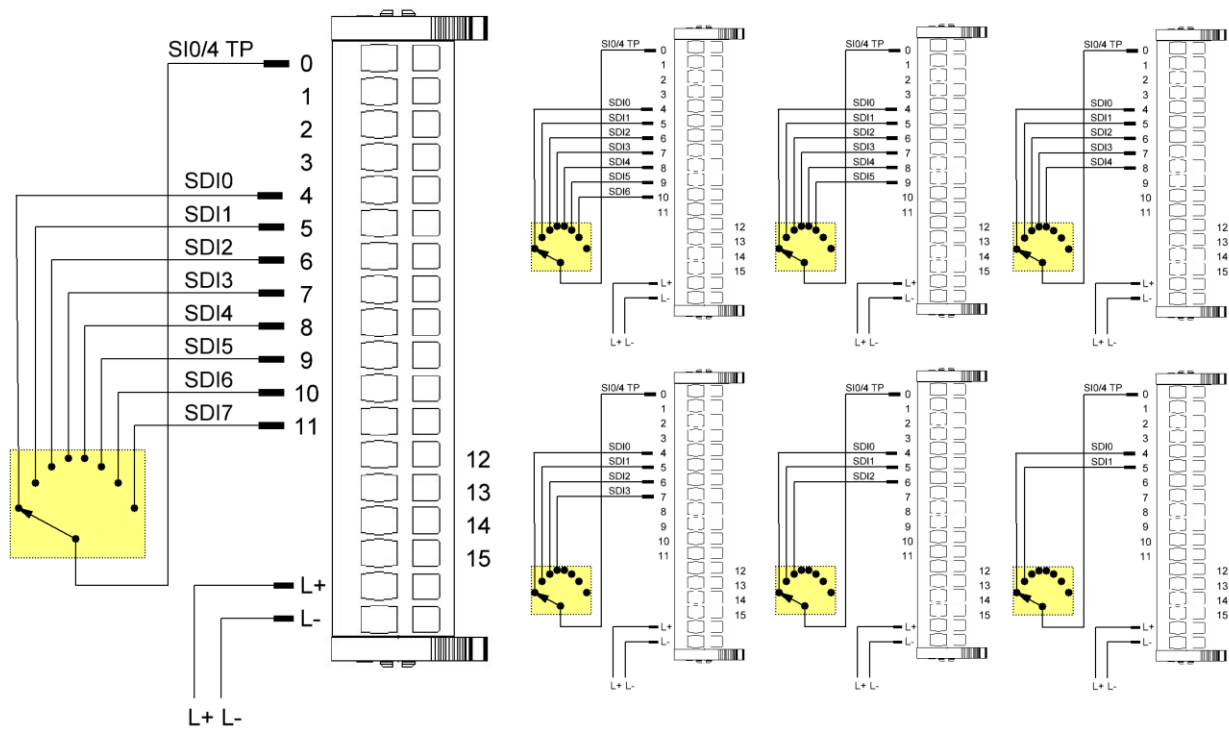

In mode selector mode "Mode Selector", you may connect 2 to 8 inputs of test pulse output SI0/4 TP to a mode selector (test pulse output SI8/12 TP for Rotary Switch 1). Disable the test pulse outputs you do not need. Use this setup together with PLC component FB\_MODE to implement a mode selector switch. The associated logical output sets only if an input is set. All other outputs remain in a safe state. If no or more than one input is set, all logical outputs retain their safe state.

Function "Rotary Switch" can be configured. Refer to manual section → 6.4.3 Input Parameters for further details.

**Safety ratings of mode selector applications in conjunction with trusted switches/sensors to EN 13849-2, Table D.3**

|   |   |
|---|---|
| Highest safety integrity level to EN 62061:2010                               | SIL2  |
| Highest safety integrity level to IEC 61508:2010                              | SIL2  |
| Category and highest performance level to EN ISO 13849-1:2015                 | Cat. 1/PL c   |
| Hardware fault tolerance (HFT) in two-channel application (IEC 61508:2010/EN) | 0<br>(a fault of the application may cause the safeguard to fail) |

**Safety ratings of mode selector applications in conjunction with certified switches/sensors of a matching safety rating**

|   |  |
|---|--|
| Highest safety integrity level to EN 62061:2010                               | SIL3   |
| Highest safety integrity level to IEC 61508:2010                              | SIL3   |
| Category and highest performance level to EN ISO 13849-1:2015                 | Cat. 3/PL e  |
| Hardware fault tolerance (HFT) in two-channel application (IEC 61508:2010/EN) | 1<br>(a fault of the application need not cause the safeguard to fail) |

|   |  |
|---|--|
|  | <b>Note, information</b>   |
|   | <p><b>Test pulse frequency</b></p> <p>In mode selector mode, you can set up parameter "test frequency input" for the input you are using. This will not affect the test pulse frequency because, in test selector mode, that frequency is automatically set to a frequency of 50 Hz.</p> |

|   |   |
|---|---|
|  | <b>Note, information</b>  |
|   | <p><b>Time discrepancy in mode selector/rotary table mode</b></p> <p>A set time discrepancy of 100 ms has been implemented for signals missing at the inputs when changing to mode selector mode.</p> |

## 7.5 Safety Mats, Connecting Blocks and Bumpers

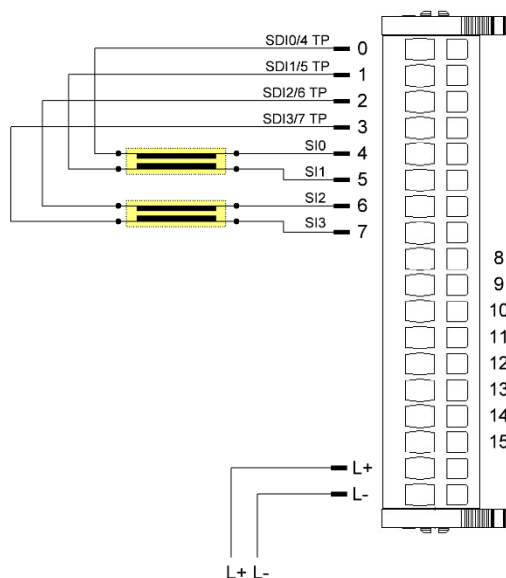

Safety mats protect operators in danger zones. Connecting blocks and bumpers are normally used as safeguards along closing edges or against potentially hazardous moving objects. They share the same tripping method. Two parallel areas of contact are kept at a certain distance and do not make contact until the device is actuated. An electric current going through the areas of contact ensures that they are ready for use. The picture illustrates that one area of contact is allocated to one channel and the other area to another channel. Mechanical load on the area of contact makes the inputs connect. This is not interpreted as a short circuit but as actuation. Use FSoE parameter "Safety Mat x" to choose function "Safety Mat" (bumper). Refer to manual section → 6.4.3 Input Parameters for further details. This mode only supports pressure-sensitive mats working according to the open circuit principle, i.e. the test pulses required to maintain a safe function are supplied by the safe I/O module.

If the safety mat function is used, be sure to set all parameter inputs to InputxExternal.

Function Safety Mat 0 uses inputs SI0, SI1 and test pulse outputs SI0/4 TP and SI1/5 TP for the modes. If so, set up and use inputs SI4 and SI5 as External, i.e. for sensors with their own or without OSSD signals. The pressure-

sensitive mat function achieves a response time of **25 ms** between a change in mat state and providing the information on the EtherCAT bus.

### Safety ratings of two-channel sensors

The safety ratings listed in the table below reflect the maximum values a two-channel safety function may achieve when using two inputs of the safe I/O module. They solely apply to the part of the safety function covered by the safe I/O module. All components involved in the safety function must be taken into account in order to assess whether the desired safety ratings are achieved. The quality of the safe sensor is of crucial importance with particular regard to the safety function of a safety mat application. Use approved sensors only (e.g. to EN 60947-5-1 / -5.) and take account of your switching device's B10d value. The safety assessment of the safety function must also consider the safety ratings of the safe PLC used in the application.

**Safety ratings for pressure-sensitive mat applications**

|   |  |
|---|--|
| Highest safety integrity level to EN 62061:2010                               | SIL3   |
| Highest safety integrity level to IEC 61508:2010                              | SIL3   |
| Category and highest performance level to EN ISO 13849-1:2015                 | Cat. 3/PL e  |
| Hardware fault tolerance (HFT) in two-channel application (IEC 61508:2010/EN) | 1<br>(a fault of the application need not cause the safeguard to fail) |

**CAUTION*****Lay the feed lines of pressure-sensitive mats and bumpers together***

*EMC interference may provoke malfunctions.*

In order to avoid influences and malfunctions due to EMC effects, lay the four wires (e.g. Safe-In 0, Safe-In 0/4 TP, Safe-In 1, Safe-In 1/5 TP) together.

**CAUTION*****"Short circuit in mat" fault is not detected***

*The safe I/O module fails to detect a short circuit between the mat contacts. This is interpreted as the mat being actuated. You must also verify that the safeguard is wired correctly.*

Periodically check that the mat is working properly.

**CAUTION*****Safety function pressure-sensitive mat requires a response time of 25 ms***

*Avoid personal injury and damage to property*

The pressure-sensitive mat function achieves a response time of 25 ms between a change in mat state and providing the information on the EtherCAT bus.

**Note, information*****Use of safe inputs along with the pressure-sensitive mats / bumper***

*Two safe inputs are allocated to every test pulse output. If a pressure-sensitive mat / bumper is used, the inputs not involved in providing the function must not be allocated to the associated test pulse outputs but set up as External Inputs instead.*

Example: if SI0, SI0/4 TP, SI1, SI1/5 TP are used, set up the associated partner inputs SI4 and SI5 as External Inputs.

## 7.6 Connecting Two Actuators with Internal GND Reference

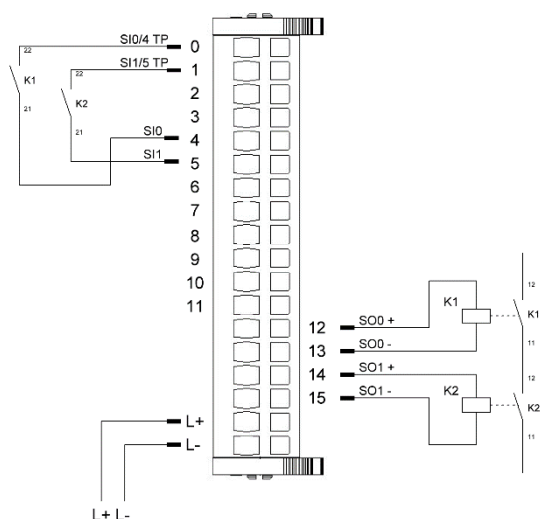

The wiring example illustrates how two outputs of the safe I/O module are used to actuate a safety function. Switch contacts K1 and K2 both affect the safety function together.

Using the SOX terminals of the outputs allows the actuator to separate from the GND connection and, thus, change to its safe state when external power is supplied to an cross-faults affect the actuator (contact SOX+). Whereas you may set up this circuit without the SOX- terminals, you must ensure that external power and cross-faults are excluded if you do.

In order to monitor the relay states, you must connect the positively drive n.c. contacts of K1 and K2 to safe digital inputs. Set the safe PLC to analyse the values returned and, thus, the states of the switching devices.

### Safety ratings of two-channel actuators

The safety ratings listed in the table below reflect the maximum values a two-channel safety function may achieve when using two outputs of the safe I/O module. They solely apply to the part of the safety function covered by the safe I/O module. All components involved in the safety function must be taken into account in order to assess whether the desired safety ratings are achieved. The quality of the safe actuator is of crucial importance with particular regard to the safety function of analysing a two-channel actuator. Only use approved actuators in due consideration of their B10d value. The safety assessment of the safety function must also consider the safety ratings of the safe PLC used in the application.

#### Safety ratings of applications using two outputs for a safety function

|   |  |
|---|--|
| Highest safety integrity level to EN 62061:2010                               | SIL3   |
| Highest safety integrity level to IEC 61508:2010                              | SIL3   |
| Category and highest performance level to EN ISO 13849-1:2015                 | Cat. 4/PL e  |
| Hardware fault tolerance (HFT) in two-channel application (IEC 61508:2010/EN) | 1<br>(a fault of the application cannot cause the safeguard to fail) |



## 7.7 Connecting Two Parallel Actuators to One Safe Output



### CAUTION

#### Setting the Test Pulse Rate

*In single-channel applications (inputs same as outputs), adapt the test pulse frequency to the application. In applications with frequent changes of state, the test pulse frequency should be at least 100x higher than the time of change of application state.*

Refer to section 6.4.2 FSoE Parameters



### CAUTION

**A current of 200 mA (typ.) may be fed back to output SOX+ if external power is supplied and a cross-fault occurs. This fact should be considered when planning the safety function.**

*The module will recognise external power and cross-faults by the test pulses returned by all inputs and outputs. It will respond by enabling the safe state and turning off all outputs. External power or cross-faults at the outputs will cause current to flow into the module. If external power is supplied "downstream" the actuator (at the SOX connector), this may generate a current flow through the actuator and into the module, which may then activate an actuator.*

*Take the following precautions if a reverse flow of 200 mA (typ.) may activate the load:*

- Use a two-channel actuation of a safety function with two safe outputs. A supply of external power or a cross-fault will be detected and enable the safe state of all module outputs.
- Ensure that the line between the SOX connector and the actuator is laid safely. Preventing external power or a cross-fault between the SOX connector and the actuator will also prevent a dangerous flow of current through the load.

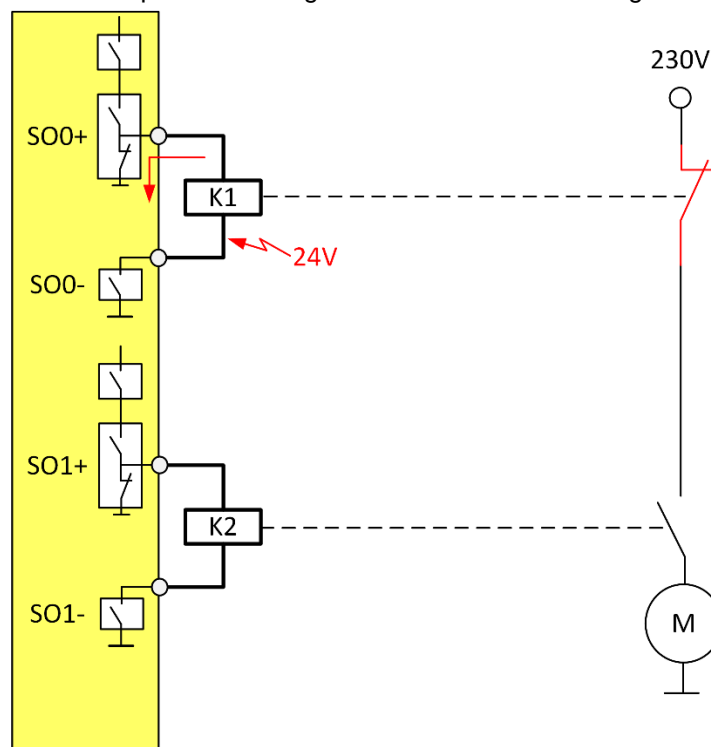

**Figure 14: Reverse current potentially provoked by external power**

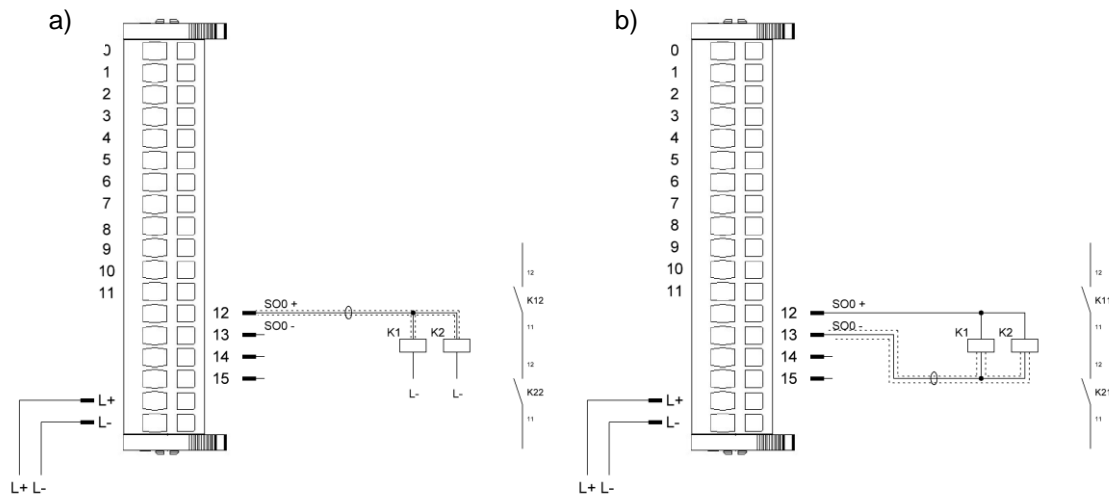

The wiring example illustrates how one output of the safe I/O module is used to actuate a safety function. Use a two-channel actuator to achieve the safety integrity levels of the table below. Please read the sections below to better understand the wiring examples.

|  |  |
|--|--|
|  | <b>CAUTION</b>   |
|  | <p><b>Fault exclusion required - schematic a)</b></p> <p>Take precautions against short circuits or cross-faults on the lead connecting the output contact (SOX+) and the safe actuators.</p> <p>Safely lay the leads, for example.</p>  |
|  | <b>CAUTION</b>   |
|  | <p><b>Consider the fault detection time - schematic a)</b></p> <p>Consider a fault detection time of <b>0.5 ms</b>, which may produce high impulses of this width in case of a fault.</p> <ul style="list-style-type: none"> <li>• Use a two-channel connection of the outputs for a safety function in case your application responds to these impulses.</li> <li>• Consider an input filter time of <b>1 ms</b> for the loads you connect.</li> <li>• This will mainly affect safe digital inputs. If an input filter is not used, the higher impedance in relation to other loads may cause a change of state. In this case, an input filter of at least <b>1 ms</b> will help to ignore an impulse.</li> </ul> |
|  | <b>CAUTION</b>   |
|  | <p><b>Fault exclusion required - schematic b)</b></p> <p>Take precautions against short circuits or cross-faults on the lead connecting the output contact (SOXS0-) and the safe actuators.</p> <p>Safely lay the leads, for example.</p>  |

In order to monitor the relay states, you must connect the positively drive n.c. contacts of K1 and K2 to safe digital inputs. Set the safe PLC to analyse the values returned and, thus, the states of the switching devices.

| Best safety ratings of applications using one output for a safety function       |  |
|--|--|
| Highest safety integrity level to EN 62061:2010                                  | SIL3   |
| Highest safety integrity level to IEC 61508:2010                                 | SIL3   |
| Category and highest performance level to EN ISO 13849-1:2015                    | Cat. 4/PL e  |
| Hardware fault tolerance (HFT) in single-channel application (IEC 61508:2010/EN) | 1<br>(a fault of the application does not cause the safeguard to fail) |

## 8 Appendix

### 8.1 Object Dictionary

#### 8.1.1 Device Type 1000<sub>h</sub>

|                        |                   |
|------------------------|-------------------|
| <b>Name</b>            | Device Type       |
| <b>Index</b>           | 1000 <sub>h</sub> |
| <b>Object Code</b>     | VARIABLE          |
| <b>No. of Elements</b> | 0                 |
| <b>Data Type</b>       | UNSIGNED32        |
| <b>Access</b>          | Read only         |
| <b>PDO Mapping</b>     | No                |
| <b>Value Range</b>     | Fix               |

#### 8.1.2 Error Register 1001<sub>h</sub>

|                        |                   |
|------------------------|-------------------|
| <b>Name</b>            | Error Register    |
| <b>Index</b>           | 1001 <sub>h</sub> |
| <b>Object Code</b>     | VARIABLE          |
| <b>No. of Elements</b> | 0                 |
| <b>Data Type</b>       | UNSIGNED8         |
| <b>Access</b>          | Read only         |
| <b>PDO Mapping</b>     | TX-PDO            |
| <b>Default Value</b>   | 00 <sub>h</sub>   |

In case of an error, the associated error bit is set. The EtherCAT I/O map also shows the error register.

| Index  | Name                        |
|--------|-----------------------------|
| 1001:0 | Generic Error               |
| 1001:1 | Current Error               |
| 1001:2 | Voltage Error               |
| 1001:3 | Temperature Error           |
| 1001:4 | Communication Error         |
| 1001:5 | Profile-specific Error      |
| 1001:6 | Empty                       |
| 1001:7 | Manufacturer-specific Error |

The [8.1.16](#) decides whether a reset by the software or power cycle is possible.

#### 8.1.3 Predefined Error Field 1003<sub>h</sub>

|                        |                        |
|------------------------|------------------------|
| <b>Name</b>            | Predefined Error Field |
| <b>Index</b>           | 1003 <sub>h</sub>      |
| <b>Object Code</b>     | VARIABLE               |
| <b>No. of Elements</b> | 8                      |
| <b>Data Type</b>       | UNSIGNED8              |
| <b>Access</b>          | Read/Write             |
| <b>PDO Mapping</b>     | No                     |

The predefined error field stores the last eight errors that occurred. A power cycle clears the memory.

| Index  | Name               |
|--------|--------------------|
| 1003:0 | Number of Elements |
| 1003:1 | Latest Error       |
| 1003:2 | 2nd Error          |
| 1003:3 | 3rd Error          |
| 1003:4 | 4th Error          |
| 1003:5 | 5th Error          |
| 1003:6 | 6th Error          |
| 1003:7 | 7th Error          |
| 1003:8 | 8th Error          |

### 8.1.4 Device Name 1008h

|                        |  |
|------------------------|--|
| <b>Name</b>            | Device Name  |
| <b>Index</b>           | 1008h  |
| <b>Object Code</b>     | VARIABLE   |
| <b>No. of Elements</b> | 0  |
| <b>Data Type</b>       | STRING (27) - STRING (29)  |
| <b>BitSize</b>         | 216 - 232  |
| <b>Access</b>          | Read only  |
| <b>PDO Mapping</b>     | No   |
| <b>Value Range</b>     | Fix  |
| <b>Default Value</b>   | Kuhnke FIO Safety SDI16 SDO4 or<br>Kuhnke FIO Safety SDI8 SDO2 or<br>Kuhnke FIO Safety SDI16 |

### 8.1.5 Hardware Version 1009h

|                        |                  |
|------------------------|------------------|
| <b>Name</b>            | Hardware Version |
| <b>Index</b>           | 1009h            |
| <b>Object Code</b>     | VARIABLE         |
| <b>No. of Elements</b> | 0                |
| <b>Data Type</b>       | STRING (4)       |
| <b>BitSize</b>         | 32               |
| <b>Access</b>          | Read only        |
| <b>PDO Mapping</b>     | No               |
| <b>Value Range</b>     | Fix              |
| <b>Default Value</b>   | 312E3130 (1.10)  |

### 8.1.6 Software Version 100Ah

|                        |                    |
|------------------------|--------------------|
| <b>Name</b>            | Software Version   |
| <b>Index</b>           | 100Ah              |
| <b>Object Code</b>     | VARIABLE           |
| <b>No. of Elements</b> | 0                  |
| <b>Data Type</b>       | VISIBLE_STRING (4) |

|                      |                 |
|----------------------|-----------------|
| <b>BitSize</b>       | 32              |
| <b>Access</b>        | Read only       |
| <b>PDO Mapping</b>   | No              |
| <b>Value Range</b>   | Fix             |
| <b>Default Value</b> | 312E3032 (1.02) |

### 8.1.7 Identity Object 1018h

The object contains details of the manufacturer, the product code and the revision and serial numbers.

|                        |                   |
|------------------------|-------------------|
| <b>Name</b>            | Identity Object   |
| <b>Index</b>           | 1018 <sub>h</sub> |
| <b>Object Code</b>     | RECORD            |
| <b>No. of Elements</b> | 5                 |
| <b>Data Type</b>       | IDENTITY          |
| <b>BitSize</b>         | 144               |

|                      |                 |
|----------------------|-----------------|
| <b>Name</b>          | Subindex 000    |
| <b>Subindex</b>      | 00 <sub>h</sub> |
| <b>Data Type</b>     | UNSIGNED8       |
| <b>Access</b>        | Read only       |
| <b>PDO Mapping</b>   | No              |
| <b>Default Value</b> | >4<             |

|                      |                       |
|----------------------|-----------------------|
| <b>Name</b>          | Vendor ID             |
| <b>Subindex</b>      | 01 <sub>h</sub>       |
| <b>Data Type</b>     | UNSIGNED32            |
| <b>Access</b>        | Read only             |
| <b>PDO Mapping</b>   | No                    |
| <b>Default Value</b> | 0048554B <sub>h</sub> |

|                      |  |
|----------------------|--|
| <b>Name</b>          | Product Code   |
| <b>Subindex</b>      | 02 <sub>h</sub>  |
| <b>Data Type</b>     | UNSIGNED32   |
| <b>Access</b>        | Read only  |
| <b>PDO Mapping</b>   | No   |
| <b>Default Value</b> | 0x2ECAD (191661 - Kuhnke FIO SDI16 SDO4)<br>0x2ECC1 (191681 - Kuhnke FIO Safety SDI8 SDO2)<br>0x2ECC2 (191682 - Kuhnke FIO Safety SDI16) |

|                      |  |
|----------------------|--|
| <b>Name</b>          | Revision Number  |
| <b>Subindex</b>      | 03 <sub>h</sub>  |
| <b>Data Type</b>     | UNSIGNED32   |
| <b>Access</b>        | Read only  |
| <b>PDO Mapping</b>   | No   |
| <b>Default Value</b> | 00000009 <sub>h</sub> (191661 - Kuhnke FIO SDI16 SDO4)<br>00000007 <sub>h</sub> (191681 - Kuhnke FIO Safety SDI8 SDO2)<br>00000007 <sub>h</sub> (191682 - Kuhnke FIO Safety SDI16) |

|                    |  |
|--------------------|--|
| <b>Name</b>        | Serial Number  |
| <b>Subindex</b>    | 04 <sub>h</sub>  |
| <b>Data Type</b>   | UNSIGNED32   |
| <b>Access</b>      | Read only  |
| <b>PDO Mapping</b> | No   |
| <b>Units</b>       | YY MM DD NNNNN<br><br>yyyyyy mmmm dddd nnnnnnnnnnnnnnnnn<br>6-bit 4-bit 5-bit 17-bit<br><br>Year 2014 is coded as '0'. |
| <b>Value Range</b> | 14 01 01 00001 (0x00420001) ...<br>77 12 31 99999 (0xFF3F869F)   |
| <b>Example</b>     | 16052300001 ⇔ 0x096E0001   |

### 8.1.8 Supply 24V Voltage 2001<sub>h</sub> for $\mu$ C1 and 2011<sub>h</sub> for $\mu$ C2

|                        |                   |
|------------------------|-------------------|
| <b>Name</b>            | Supply24Voltage   |
| <b>Index</b>           | 2001 <sub>h</sub> |
| <b>Object Code</b>     | VARIABLE          |
| <b>No. of Elements</b> | 0                 |
| <b>Data Type</b>       | UNSIGNED16        |
| <b>Access</b>          | Read only         |
| <b>PDO Mapping</b>     | No                |
| <b>Units</b>           | mV                |
| <b>Value Range</b>     | 0 ... 65535       |
| <b>Default Value</b>   | No default value  |

### 8.1.9 Supply 5 V voltage 2002<sub>h</sub> for $\mu$ C1 and 2012<sub>h</sub> for $\mu$ C2

|                        |                   |
|------------------------|-------------------|
| <b>Name</b>            | Supply5Voltage    |
| <b>Index</b>           | 2002 <sub>h</sub> |
| <b>Object Code</b>     | VARIABLE          |
| <b>No. of Elements</b> | 0                 |
| <b>Data Type</b>       | UNSIGNED16        |
| <b>Access</b>          | Read only         |
| <b>PDO Mapping</b>     | No                |
| <b>Units</b>           | mV                |

|               |                  |
|---------------|------------------|
| Value Range   | 0 ... 65535      |
| Default Value | No default value |

### 8.1.10 Supply 3.3 V voltage 2003<sub>h</sub> for $\mu$ C1 and 2013<sub>h</sub> for $\mu$ C2

|                 |                   |
|-----------------|-------------------|
| Name            | Supply3_3Voltage  |
| Index           | 2003 <sub>h</sub> |
| Object Code     | VARIABLE          |
| No. of Elements | 0                 |
| Data Type       | UNSIGNED16        |
| Access          | Read only         |
| PDO Mapping     | No                |
| Units           | mV                |
| Value Range     | 0 ... 65535       |
| Default Value   | No default value  |

### 8.1.11 Temperature 2004<sub>h</sub> for $\mu$ C1

|                 |                   |
|-----------------|-------------------|
| Name            | CPU Temperature   |
| Index           | 2006 <sub>h</sub> |
| Object Code     | VARIABLE          |
| No. of Elements | 0                 |
| Data Type       | UNSIGNED16        |
| Access          | Read only         |
| PDO Mapping     | No                |
| Units           | 0.1 °C            |
| Value Range     | 0 ... 1500        |
| Default Value   | No default value  |

### 8.1.12 Ext Temperature 2006<sub>h</sub> for $\mu$ C1

|                 |                   |
|-----------------|-------------------|
| Name            | Ext Temperature   |
| Index           | 2006 <sub>h</sub> |
| Object Code     | VARIABLE          |
| No. of Elements | 0                 |
| Data Type       | UNSIGNED32        |
| Access          | Read only         |
| PDO Mapping     | No                |
| Units           | 0.1 °C            |
| Value Range     | 0 ... 1500        |
| Default Value   | No default value  |



#### **Note, information**

**Only analyse the lowest 16 bit to be shown the temperature.**



|   |  |
|---|--|
|  | <b>Note, information</b>   |
|   | <i>The temperature value is not intended for safety-related evaluation.<br/>Do not use in safety functions !</i> |

### 8.1.13 Err.code 2007<sub>h</sub> for $\mu$ C1 and 2017<sub>h</sub> for $\mu$ C2

|                        |                   |
|------------------------|-------------------|
| <b>Name</b>            | Err.code          |
| <b>Index</b>           | 2007 <sub>h</sub> |
| <b>Object Code</b>     | VARIABLE          |
| <b>No. of Elements</b> | 0                 |
| <b>Data Type</b>       | UNSIGNED16        |
| <b>Access</b>          | Read only         |
| <b>PDO Mapping</b>     | No                |
| <b>Default Value</b>   | 0000 <sub>h</sub> |

The table below explains the entries in object 2007<sub>h</sub> or 2017<sub>h</sub> "Err.code".

| <b>Id</b>  | <b>Hex</b> | <b>Explanation</b>  |
|------------|------------|---|
| <b>0</b>   | 0x0000     | OK: No error (same for CORA)  |
| <b>1</b>   | 0x0001     | HWT_PARAMETER_ERROR (from CORA)   |
| <b>2</b>   | 0x0002     | HWT_INIT_ERROR (from CORA)  |
| <b>100</b> | 0x0064     | HWT_MEM_MARCHC_ERROR (from CORA)  |
| <b>101</b> | 0x0065     | HWT_MEM_GALPAT_ERROR (from CORA)  |
| <b>200</b> | 0x00C8     | HWT_STACK_UNDERFLOW_ERROR (from CORA)   |
| <b>201</b> | 0x00C9     | HWT_STACK_OVERFLOW_ERROR (from CORA)  |
| <b>300</b> | 0x012C     | HWT_CPU_ERROR (from CORA)   |
| <b>400</b> | 0x0190     | HWT_FW_ERROR (from CORA)  |
| <b>500</b> | 0x01F4     | HWT_FWINTERFACE_ERROR (from CORA)   |
| <b>504</b> | 0x01F8     | HWT_ADC_ERROR: Test Handler: error in ADC value range checks                                    |
| <b>505</b> | 0x01F9     | HWT_DMA_ERROR: Test Handler: error in DMA check   |
| <b>506</b> | 0x01FA     | HWT_CRC_ERROR: Test Handler: error in CRC check   |
| <b>507</b> | 0x01FB     | HWT_TIMER_ERROR: Test Handler: error in timer check   |
| <b>508</b> | 0x01FC     | HWT_CLOCK_ERROR: Test Handler: error in clock signal check                                      |
| <b>509</b> | 0x01FD     | HWT_SOFTERROR: Softerror detected   |
| <b>510</b> | 0x01FE     | HWT_DIVZERO: Division by 0  |
| <b>544</b> | 0x0220     | INIT_ERROR: Initialisation error  |
| <b>576</b> | 0x0240     | TIMEOUT_ERR: Timeout detected.  |
| <b>578</b> | 0x0242     | TIMEOUTTIMERERR: Timeout occurred   |
| <b>579</b> | 0x0243     | POWERUP_TIMEOUT: While waiting for valid supply voltage values during power up timeout occurred |
| <b>672</b> | 0x02A0     | MRAM_NOT_INITIALIZED: MRAM communication is not initialized.                                    |
| <b>673</b> | 0x02A1     | MRAM_READ_ERR: MRAM read error.   |
| <b>674</b> | 0x02A2     | MRAM_WRITE_ERR: MRAM write error.   |

| <b>Id</b> | <b>Hex</b> | <b>Explanation</b>   |
|-----------|------------|--|
| 675       | 0x02A3     | MRAM_INDEX_OUT_OF_RANGE: MRAM entry index out of valid range.                  |
| 676       | 0x02A4     | MRAM_CORRUPT_PAGE_SIZE: MRAM page size invalid.                                |
| 677       | 0x02A5     | MRAM_CRC_ERR: MRAM data CRC check failed.                                      |
| 678       | 0x02A6     | MRAM_MAGICNUMBER_ERR: MRAM magic number not recognized.                        |
| 768       | 0x0300     | CONF_MAXSWITCH_EXCEEDED: Anzahl der Wahlschalter zu gross                      |
| 769       | 0x0301     | CONF_MAXSWITCHPOS_EXCEEDED: Anzahl der Wahlschalterstellungen zu gross         |
| 770       | 0x0302     | CONF_SWITCH_MAT_ERR: Anzahl Schaltmatten und Wahlschalter falsch               |
| 771       | 0x0303     | CONF_INP_DURATION_ERR: Eingangstestpulsdauer falsch                            |
| 1344      | 0x0540     | Sync of MC1 and MC2 failed.  |
| 1456      | 0x05B0     | MAT_CNTRL_ERR: Mat 0 sequence control detected error.                          |
| 1457      | 0x05B1     | MAT_CNTRL_ERR: Mat 1 sequence control detected error.                          |
| 1458      | 0x05B3     | MAT_CNTRL_ERR: Mat 3 sequence control detected error.                          |
| 1459      | 0x05B3     | MAT_CNTRL_ERR: Mat 3 sequence control detected error.                          |
| 1471      | 0x05BF     | PRG_CNTRL_ERR: Program sequence control detected error.                        |
| 1472      | 0x05C0     | RSW_CNTRL_ERR: Rotary switch control detected error (Inp 0).                   |
| 1473      | 0x05C1     | RSW_CNTRL_ERR: Rotary switch control detected error (Inp 1).                   |
| 1474      | 0x05C2     | RSW_CNTRL_ERR: Rotary switch control detected error (Inp 2).                   |
| 1475      | 0x05C3     | RSW_CNTRL_ERR: Rotary switch control detected error (Inp 3).                   |
| 1476      | 0x05C4     | RSW_CNTRL_ERR: Rotary switch control detected error (Inp 4).                   |
| 1477      | 0x05C5     | RSW_CNTRL_ERR: Rotary switch control detected error (Inp 5).                   |
| 1478      | 0x05C6     | RSW_CNTRL_ERR: Rotary switch control detected error (Inp 6).                   |
| 1479      | 0x05C7     | RSW_CNTRL_ERR: Rotary switch control detected error (Inp 7).                   |
| 1480      | 0x05C8     | RSW_CNTRL_ERR: Rotary switch control detected error (Inp 8).                   |
| 1481      | 0x05C9     | RSW_CNTRL_ERR: Rotary switch control detected error (Inp 9).                   |
| 1482      | 0x05CA     | RSW_CNTRL_ERR: Rotary switch control detected error (Inp 10).                  |
| 1483      | 0x05CB     | RSW_CNTRL_ERR: Rotary switch control detected error (Inp 11).                  |
| 1484      | 0x05CC     | RSW_CNTRL_ERR: Rotary switch control detected error (Inp 12).                  |
| 1485      | 0x05CD     | RSW_CNTRL_ERR: Rotary switch control detected error (Inp 13).                  |
| 1486      | 0x05CE     | RSW_CNTRL_ERR: Rotary switch control detected error (Inp 14).                  |
| 1487      | 0x05CF     | RSW_CNTRL_ERR: Rotary switch control detected error (Inp 15).                  |
| 1488      | 0x05D0     | BIST_SEQ_ERR: BIST sequence control detected error.                            |
| 1504      | 0x05E0     | RESET_LOW_POWER: Reset due to low power supply.                                |
| 1505      | 0x05E1     | RESET_WINDOW_WD: Reset due to window watchdog.                                 |
| 1506      | 0x05E2     | RESET_INDEPENDENT_WD: Reset due to independent watchdog.                       |
| 1507      | 0x05E3     | RESET_SW: Reset due to software reset.   |
| 1508      | 0x05E4     | RESET_POWER_ON_DOWN: Reset due to power up or down.                            |
| 1509      | 0x05E5     | RESET_NMI: Reset due to non maskable interrupt.                                |
| 1510      | 0x05E6     | RESET_BROWNOUT: Reset due to brown out detection.                              |
| 1511      | 0x05E7     | RESET_NO_REASON: Reset due to unknown reason.                                  |
| 1537      | 0x0601     | INPUT_TIMEOUT: Input test pulse timed out. (ErrReg: 32)                        |
| 1552      | 0x0610     | INP_EXTMATTE_NOTOK: Safety mat '\$0\$' not connected / open load (ErrReg: 32). |
| 1553      | 0x0611     | INP_EXTMATTE_NOTOK: Safety mat '\$1\$' not connected / open load (ErrReg: 32). |

| <b>Id</b> | <b>Hex</b> | <b>Explanation</b>  |
|-----------|------------|---|
| 1554      | 0x0612     | INP_EXTMATTE_NOTOK: Safety mat '\$2\$' not connected / open load (ErrReg: 32).        |
| 1555      | 0x0613     | INP_EXTMATTE_NOTOK: Safety mat '\$3\$' not connected / open load (ErrReg: 32).        |
| 1568      | 0x0620     | INP_TP_BUSY: Input '\$0\$' test pulse operation is busy.                              |
| 1569      | 0x0621     | INP_TP_BUSY: Input '\$1\$' test pulse operation is busy.                              |
| 1570      | 0x0622     | INP_TP_BUSY: Input '\$2\$' test pulse operation is busy.                              |
| 1571      | 0x0623     | INP_TP_BUSY: Input '\$3\$' test pulse operation is busy.                              |
| 1572      | 0x0624     | INP_TP_BUSY: Input '\$4\$' test pulse operation is busy.                              |
| 1573      | 0x0625     | INP_TP_BUSY: Input '\$5\$' test pulse operation is busy.                              |
| 1574      | 0x0626     | INP_TP_BUSY: Input '\$6\$' test pulse operation is busy.                              |
| 1575      | 0x0627     | INP_TP_BUSY: Input '\$7\$' test pulse operation is busy.                              |
| 1576      | 0x0628     | INP_TP_BUSY: Input '\$8\$' test pulse operation is busy.                              |
| 1577      | 0x0629     | INP_TP_BUSY: Input '\$9\$' test pulse operation is busy.                              |
| 1578      | 0x062A     | INP_TP_BUSY: Input '\$10\$' test pulse operation is busy.                             |
| 1579      | 0x062B     | INP_TP_BUSY: Input '\$11\$' test pulse operation is busy.                             |
| 1580      | 0x062C     | INP_TP_BUSY: Input '\$12\$' test pulse operation is busy.                             |
| 1581      | 0x062D     | INP_TP_BUSY: Input '\$13\$' test pulse operation is busy.                             |
| 1582      | 0x062E     | INP_TP_BUSY: Input '\$14\$' test pulse operation is busy.                             |
| 1583      | 0x062F     | INP_TP_BUSY: Input '\$15\$' test pulse operation is busy.                             |
| 1584      | 0x0630     | INP_TP_CROSSTALK: Input '\$0\$' test pulse cross talk detected.                       |
| 1585      | 0x0631     | INP_TP_CROSSTALK: Input '\$1\$' test pulse cross talk detected.                       |
| 1586      | 0x0632     | INP_TP_CROSSTALK: Input '\$2\$' test pulse cross talk detected.                       |
| 1587      | 0x0633     | INP_TP_CROSSTALK: Input '\$3\$' test pulse cross talk detected.                       |
| 1588      | 0x0634     | INP_TP_CROSSTALK: Input '\$4\$' test pulse cross talk detected.                       |
| 1589      | 0x0635     | INP_TP_CROSSTALK: Input '\$5\$' test pulse cross talk detected.                       |
| 1590      | 0x0636     | INP_TP_CROSSTALK: Input '\$6\$' test pulse cross talk detected.                       |
| 1591      | 0x0637     | INP_TP_CROSSTALK: Input '\$7\$' test pulse cross talk detected.                       |
| 1592      | 0x0638     | INP_TP_CROSSTALK: Input '\$8\$' test pulse cross talk detected.                       |
| 1593      | 0x0639     | INP_TP_CROSSTALK: Input '\$9\$' test pulse cross talk detected.                       |
| 1594      | 0x063A     | INP_TP_CROSSTALK: Input '\$10\$' test pulse cross talk detected.                      |
| 1595      | 0x063B     | INP_TP_CROSSTALK: Input '\$11\$' test pulse cross talk detected.                      |
| 1596      | 0x063C     | INP_TP_CROSSTALK: Input '\$12\$' test pulse cross talk detected.                      |
| 1597      | 0x063D     | INP_TP_CROSSTALK: Input '\$13\$' test pulse cross talk detected.                      |
| 1598      | 0x063E     | INP_TP_CROSSTALK: Input '\$14\$' test pulse cross talk detected.                      |
| 1599      | 0x063F     | INP_TP_CROSSTALK: Input '\$15\$' test pulse cross talk detected.                      |
| 1600      | 0x0640     | INP_TP_NOT_RECOGNIZED: Safety input '\$0/4\$' test pulse not detected (TPO '\$0\$').  |
| 1601      | 0x0641     | INP_TP_NOT_RECOGNIZED: Safety input '\$1/5\$' test pulse not detected (TPO '\$1\$').  |
| 1602      | 0x0642     | INP_TP_NOT_RECOGNIZED: Safety input '\$2/6\$' test pulse not detected (TPO '\$2\$').  |
| 1603      | 0x0643     | INP_TP_NOT_RECOGNIZED: Safety input '\$3/7\$' test pulse not detected (TPO '\$3\$').  |
| 1604      | 0x0644     | INP_TP_NOT_RECOGNIZED: Safety input '\$8/12\$' test pulse not detected (TPO '\$4\$'). |
| 1605      | 0x0645     | INP_TP_NOT_RECOGNIZED: Safety input '\$9/13\$' test pulse not detected (TPO '\$5\$'). |

| <b>Id</b> | <b>Hex</b> | <b>Explanation</b>   |
|-----------|------------|--|
| 1606      | 0x0646     | INP_TP_NOT_RECOGNIZED: Safety input '\$10/14\$' test pulse not detected (TPO '\$6\$').             |
| 1607      | 0x0647     | INP_TP_NOT_RECOGNIZED: Safety input '\$11/15\$' test pulse not detected (TPO '\$7\$').             |
| 1616      | 0x0650     | INP_TP_INV_CNT_FOR_SEL: Invalid number of test pulses detected for safety selector switch (In 0).  |
| 1617      | 0x0651     | INP_TP_INV_CNT_FOR_SEL: Invalid number of test pulses detected for safety selector switch (In 1).  |
| 1618      | 0x0652     | INP_TP_INV_CNT_FOR_SEL: Invalid number of test pulses detected for safety selector switch (In 2).  |
| 1619      | 0x0653     | INP_TP_INV_CNT_FOR_SEL: Invalid number of test pulses detected for safety selector switch (In 3).  |
| 1620      | 0x0654     | INP_TP_INV_CNT_FOR_SEL: Invalid number of test pulses detected for safety selector switch (In 4).  |
| 1621      | 0x0655     | INP_TP_INV_CNT_FOR_SEL: Invalid number of test pulses detected for safety selector switch (In 5).  |
| 1622      | 0x0656     | INP_TP_INV_CNT_FOR_SEL: Invalid number of test pulses detected for safety selector switch (In 6).  |
| 1623      | 0x0657     | INP_TP_INV_CNT_FOR_SEL: Invalid number of test pulses detected for safety selector switch (In 7).  |
| 1624      | 0x0658     | INP_TP_INV_CNT_FOR_SEL: Invalid number of test pulses detected for safety selector switch (In 8).  |
| 1625      | 0x0659     | INP_TP_INV_CNT_FOR_SEL: Invalid number of test pulses detected for safety selector switch (In 9).  |
| 1626      | 0x065A     | INP_TP_INV_CNT_FOR_SEL: Invalid number of test pulses detected for safety selector switch (In 10). |
| 1627      | 0x065B     | INP_TP_INV_CNT_FOR_SEL: Invalid number of test pulses detected for safety selector switch (In 11). |
| 1628      | 0x065C     | INP_TP_INV_CNT_FOR_SEL: Invalid number of test pulses detected for safety selector switch (In 12). |
| 1629      | 0x065D     | INP_TP_INV_CNT_FOR_SEL: Invalid number of test pulses detected for safety selector switch (In 13). |
| 1630      | 0x065E     | INP_TP_INV_CNT_FOR_SEL: Invalid number of test pulses detected for safety selector switch (In 14). |
| 1631      | 0x065F     | INP_TP_INV_CNT_FOR_SEL: Invalid number of test pulses detected for safety selector switch (In 15). |
| 1632      | 0x0660     | INP_INTTP_NOT_RECOGNIZED: Internal input '\$0\$' test pulse not detected.                          |
| 1633      | 0x0661     | INP_INTTP_NOT_RECOGNIZED: Internal input '\$1\$' test pulse not detected.                          |
| 1634      | 0x0662     | INP_INTTP_NOT_RECOGNIZED: Internal input '\$2\$' test pulse not detected.                          |
| 1635      | 0x0663     | INP_INTTP_NOT_RECOGNIZED: Internal input '\$3\$' test pulse not detected.                          |
| 1636      | 0x0664     | INP_INTTP_NOT_RECOGNIZED: Internal input '\$4\$' test pulse not detected.                          |
| 1637      | 0x0665     | INP_INTTP_NOT_RECOGNIZED: Internal input '\$5\$' test pulse not detected.                          |
| 1638      | 0x0666     | INP_INTTP_NOT_RECOGNIZED: Internal input '\$6\$' test pulse not detected.                          |
| 1639      | 0x0667     | INP_INTTP_NOT_RECOGNIZED: Internal input '\$7\$' test pulse not detected.                          |
| 1640      | 0x0668     | INP_INTTP_NOT_RECOGNIZED: Internal input '\$8\$' test pulse not detected.                          |

| <b>Id</b> | <b>Hex</b> | <b>Explanation</b>   |
|-----------|------------|--|
| 1641      | 0x0669     | INP_INTTP_NOT_RECOGNIZED: Internal input '\$9\$' test pulse not detected.        |
| 1642      | 0x066A     | INP_INTTP_NOT_RECOGNIZED: Internal input '\$10\$' test pulse not detected.       |
| 1643      | 0x066B     | INP_INTTP_NOT_RECOGNIZED: Internal input '\$11\$' test pulse not detected.       |
| 1644      | 0x066C     | INP_INTTP_NOT_RECOGNIZED: Internal input '\$12\$' test pulse not detected.       |
| 1645      | 0x066D     | INP_INTTP_NOT_RECOGNIZED: Internal input '\$13\$' test pulse not detected.       |
| 1646      | 0x066E     | INP_INTTP_NOT_RECOGNIZED: Internal input '\$14\$' test pulse not detected.       |
| 1647      | 0x066F     | INP_INTTP_NOT_RECOGNIZED: Internal input '\$15\$' test pulse not detected.       |
| 1648      | 0x0670     | INP_INTTP_CROSSTALK: Internal input '\$0\$' test pulse cross talk detected.      |
| 1649      | 0x0671     | INP_INTTP_CROSSTALK: Internal input '\$1\$' test pulse cross talk detected.      |
| 1650      | 0x0672     | INP_INTTP_CROSSTALK: Internal input '\$2\$' test pulse cross talk detected.      |
| 1651      | 0x0673     | INP_INTTP_CROSSTALK: Internal input '\$3\$' test pulse cross talk detected.      |
| 1652      | 0x0674     | INP_INTTP_CROSSTALK: Internal input '\$4\$' test pulse cross talk detected.      |
| 1653      | 0x0675     | INP_INTTP_CROSSTALK: Internal input '\$5\$' test pulse cross talk detected.      |
| 1654      | 0x0676     | INP_INTTP_CROSSTALK: Internal input '\$6\$' test pulse cross talk detected.      |
| 1655      | 0x0677     | INP_INTTP_CROSSTALK: Internal input '\$7\$' test pulse cross talk detected.      |
| 1656      | 0x0678     | INP_INTTP_CROSSTALK: Internal input '\$8\$' test pulse cross talk detected.      |
| 1657      | 0x0679     | INP_INTTP_CROSSTALK: Internal input '\$9\$' test pulse cross talk detected.      |
| 1658      | 0x067A     | INP_INTTP_CROSSTALK: Internal input '\$10\$' test pulse cross talk detected.     |
| 1659      | 0x067B     | INP_INTTP_CROSSTALK: Internal input '\$11\$' test pulse cross talk detected.     |
| 1660      | 0x067C     | INP_INTTP_CROSSTALK: Internal input '\$12\$' test pulse cross talk detected.     |
| 1661      | 0x067D     | INP_INTTP_CROSSTALK: Internal input '\$13\$' test pulse cross talk detected.     |
| 1662      | 0x067E     | INP_INTTP_CROSSTALK: Internal input '\$14\$' test pulse cross talk detected.     |
| 1663      | 0x067F     | INP_INTTP_CROSSTALK: Internal input '\$15\$' test pulse cross talk detected.     |
| 1664      | 0x0680     | SWINP_TP_CROSSTALK: Rotary switch '\$1\$' rests at inclined position.            |
| 1665      | 0x0681     | SWINP_TP_CROSSTALK: Rotary switch '\$2\$' rests at inclined position.            |
| 1680      | 0x0690     | SWINP_TP_INV_OUT_WIRING: Rotary switch '\$1\$' connected to invalid wired lines. |
| 1681      | 0x0691     | SWINP_TP_INV_OUT_WIRING: Rotary switch '\$2\$' connected to invalid wired lines. |
| 1696      | 0x06A0     | SWINP_TP_NOT_RECOGNIZED: Rotary switch '\$1\$' - Internal input test pulse lost. |
| 1697      | 0x06A1     | SWINP_TP_NOT_RECOGNIZED: Rotary switch '\$1\$' - Internal input test pulse lost. |
| 1698      | 0x06A2     | SWINP_TP_NOT_RECOGNIZED: Rotary switch '\$1\$' - Internal input test pulse lost. |
| 1699      | 0x06A3     | SWINP_TP_NOT_RECOGNIZED: Rotary switch '\$1\$' - Internal input test pulse lost. |
| 1700      | 0x06A4     | SWINP_TP_NOT_RECOGNIZED: Rotary switch '\$1\$' - Internal input test pulse lost. |
| 1701      | 0x06A5     | SWINP_TP_NOT_RECOGNIZED: Rotary switch '\$1\$' - Internal input test pulse lost. |
| 1702      | 0x06A6     | SWINP_TP_NOT_RECOGNIZED: Rotary switch '\$1\$' - Internal input test pulse lost. |
| 1703      | 0x06A7     | SWINP_TP_NOT_RECOGNIZED: Rotary switch '\$1\$' - Internal input test pulse lost. |
| 1704      | 0x06A8     | SWINP_TP_NOT_RECOGNIZED: Rotary switch '\$2\$' - Internal input test pulse lost. |
| 1705      | 0x06A9     | SWINP_TP_NOT_RECOGNIZED: Rotary switch '\$2\$' - Internal input test pulse lost. |
| 1706      | 0x06AA     | SWINP_TP_NOT_RECOGNIZED: Rotary switch '\$2\$' - Internal input test pulse lost. |
| 1707      | 0x06AB     | SWINP_TP_NOT_RECOGNIZED: Rotary switch '\$2\$' - Internal input test pulse lost. |
| 1708      | 0x06AC     | SWINP_TP_NOT_RECOGNIZED: Rotary switch '\$2\$' - Internal input test pulse lost. |
| 1709      | 0x06AD     | SWINP_TP_NOT_RECOGNIZED: Rotary switch '\$2\$' - Internal input test pulse lost. |
| 1710      | 0x06AE     | SWINP_TP_NOT_RECOGNIZED: Rotary switch '\$2\$' - Internal input test pulse lost. |

| <b>Id</b> | <b>Hex</b> | <b>Explanation</b>  |
|-----------|------------|---|
| 1711      | 0x06AF     | SWINP_TP_NOT_RECOGNIZED: Rotary switch '\$2\$' - Internal input test pulse lost.  |
| 1793      | 0x0701     | OUT_FAILSAFE: Change to fail safe state.  |
| 1824      | 0x0720     | OUT_WAITFB: Output '\$0\$' test pulse waiting for feedback signal (ErrReg: 32).   |
| 1825      | 0x0721     | OUT_WAITFB: Output '\$1\$' test pulse waiting for feedback signal (ErrReg: 32).   |
| 1826      | 0x0722     | OUT_WAITFB: Output '\$2\$' test pulse waiting for feedback signal (ErrReg: 32).   |
| 1827      | 0x0723     | OUT_WAITFB: Output '\$3\$' test pulse waiting for feedback signal (ErrReg: 32).   |
| 1840      | 0x0730     | OUT_TIMEOUT: Timeout in handling of output '\$0\$' (ErrReg: 32).                  |
| 1841      | 0x0731     | OUT_TIMEOUT: Timeout in handling of output '\$1\$' (ErrReg: 32).                  |
| 1842      | 0x0732     | OUT_TIMEOUT: Timeout in handling of output '\$2\$' (ErrReg: 32).                  |
| 1843      | 0x0733     | OUT_TIMEOUT: Timeout in handling of output '\$3\$' (ErrReg: 32).                  |
| 1856      | 0x0740     | OUT_THERMOERR: Output '\$0\$' detected overload signal from output driver chip.   |
| 1857      | 0x0741     | OUT_THERMOERR: Output '\$1\$' detected overload signal from output driver chip.   |
| 1858      | 0x0742     | OUT_THERMOERR: Output '\$2\$' detected overload signal from output driver chip.   |
| 1859      | 0x0743     | OUT_THERMOERR: Output '\$3\$' detected overload signal from output driver chip.   |
| 1872      | 0x0750     | OUT_LSTP_TIMEOUT: Output '\$0\$' test pulse of low side switch timed out.         |
| 1873      | 0x0751     | OUT_LSTP_TIMEOUT: Output '\$1\$' test pulse of low side switch timed out.         |
| 1874      | 0x0752     | OUT_LSTP_TIMEOUT: Output '\$2\$' test pulse of low side switch timed out.         |
| 1875      | 0x0753     | OUT_LSTP_TIMEOUT: Output '\$3\$' test pulse of low side switch timed out.         |
| 1904      | 0x0770     | OUT_USTP_TIMEOUT: Output '\$0\$' test pulse of common high side switch timed out. |
| 1905      | 0x0771     | OUT_USTP_TIMEOUT: Output '\$1\$' test pulse of common high side switch timed out. |
| 1906      | 0x0772     | OUT_USTP_TIMEOUT: Output '\$2\$' test pulse of common high side switch timed out. |
| 1907      | 0x0773     | OUT_USTP_TIMEOUT: Output '\$3\$' test pulse of common high side switch timed out. |
| 1936      | 0x0790     | OUT_OUTP_INIT_ERR: Output '\$0\$' init test not OK.                               |
| 1937      | 0x0791     | OUT_OUTP_INIT_ERR: Output '\$1\$' init test not OK.                               |
| 1938      | 0x0792     | OUT_OUTP_INIT_ERR: Output '\$2\$' init test not OK.                               |
| 1939      | 0x0793     | OUT_OUTP_INIT_ERR: Output '\$3\$' init test not OK.                               |
| 1944      | 0x0798     | OUT_OUTP_US_INIT_ERR: Output not OK during initial test of superior switch.       |
| 1945      | 0x0799     | OUT_OUTP_US_INIT_ERR: Output not OK during initial test of superior switch.       |
| 1946      | 0x0800     | OUT_OUTP_US_INIT_ERR: Output not OK during initial test of superior switch.       |
| 1947      | 0x0801     | OUT_OUTP_US_INIT_ERR: Output not OK during initial test of superior switch.       |
| 1952      | 0x07A0     | OUT_TP_NOT_RECOGNIZED: Output '\$0\$' test pulse not detected. (ErrReg: 32).      |
| 1953      | 0x07A1     | OUT_TP_NOT_RECOGNIZED: Output '\$1\$' test pulse not detected. (ErrReg: 32).      |
| 1954      | 0x07A2     | OUT_TP_NOT_RECOGNIZED: Output '\$2\$' test pulse not detected. (ErrReg: 32).      |
| 1955      | 0x07A3     | OUT_TP_NOT_RECOGNIZED: Output '\$3\$' test pulse not detected. (ErrReg: 32).      |
| 1968      | 0x07B0     | OUT_TP_NOT_ACTIVE: Output '\$0\$' test pulse not activated. (ErrReg: 32).         |
| 1969      | 0x07B1     | OUT_TP_NOT_ACTIVE: Output '\$1\$' test pulse not activated. (ErrReg: 32).         |
| 1970      | 0x07B2     | OUT_TP_NOT_ACTIVE: Output '\$2\$' test pulse not activated. (ErrReg: 32).         |
| 1971      | 0x07B3     | OUT_TP_NOT_ACTIVE: Output '\$3\$' test pulse not activated. (ErrReg: 32).         |

| Id   | Hex    | Explanation   |
|------|--------|---|
| 2048 | 0x0800 | MAT_PARA_DURATION: Inconsistent time values for test pulses of inputs of mat 0.   |
| 2049 | 0x0801 | MAT_PARA_DURATION: Inconsistent time values for test pulses of inputs of mat 1.   |
| 2050 | 0x0802 | MAT_PARA_DURATION: Inconsistent time values for test pulses of inputs of mat 2.   |
| 2051 | 0x0803 | MAT_PARA_DURATION: Inconsistent time values for test pulses of inputs of mat 3.   |
| 2064 | 0x0810 | MAT_TP_DIFF: Inconsistent test pulses stay present for mat 0.   |
| 2065 | 0x0811 | MAT_TP_DIFF: Inconsistent test pulses stay present for mat 1.   |
| 2066 | 0x0812 | MAT_TP_DIFF: Inconsistent test pulses stay present for mat 2.   |
| 2067 | 0x0813 | MAT_TP_DIFF: Inconsistent test pulses stay present for mat 3.   |
| 2528 | 0x09E0 | Runtimes of 1 ms und 1 $\mu$ s timer deviate more than allowed limit  |
| 2529 | 0x09E1 | Call of test function not at expected period time   |
| 2530 | 0x09E2 | TST_CALLCNT_INV: Call counts of test functions not at same level  |
| 2640 | 0x0A50 | ASSERT_TRUE_ERR: Assertion for expression yields '\$true\$' failed.   |
| 2641 | 0x0A51 | ASSERT_NOT_NULL_ERR: Assertion for unequal to NULL failed.  |
| 2642 | 0x0A52 | ASSERT_GE_ERR: Assertion for '\$>=\$' comparision failed.   |
| 2643 | 0x0A53 | ASSERT_GT_ERR: Assertion for '\$>\$' comparision failed.  |
| 2644 | 0x0A54 | ASSERT_LE_ERR: Assertion for '\$<=\$' comparision failed.   |
| 2645 | 0x0A55 | ASSERT_LT_ERR: Assertion for '\$<\$' comparision failed.  |
| 2646 | 0x0A56 | ASSERT_NE_ERR: Assertion for '\$<>\$' comparision failed.   |
| 2647 | 0x0A57 | ASSERT_EQ_ERR: Assertion for '\$=\$' comparision failed.  |
| 2648 | 0x0A58 | ASSERT_FALSE_ERR: Assertion for expression yields '\$false\$' failed.   |
| 2768 | 0x0AD0 | ADC_REF_LOW: Reference voltage too low.   |
| 2769 | 0x0AD1 | ADC_REF_HIGH: Reference voltage too high.   |
| 2770 | 0x0AD2 | ADC_24V_LOW: 24 V supply voltage too low (< 24V - 15%). (ErrReg: 4)   |
| 2771 | 0x0AD3 | ADC_24V_HIGH: 24 V supply voltage too high (> 24V + 20%). (ErrReg: 4)   |
| 2772 | 0x0AD4 | ADC_5V_LOW: 5 V supply voltage too low. (ErrReg: 4)   |
| 2773 | 0x0AD5 | ADC_5V_HIGH: 5 V supply voltage too high. (ErrReg: 4)   |
| 2774 | 0x0AD6 | ADC_3_3V_LOW: 3,3 V supply voltage too low.   |
| 2775 | 0x0AD7 | ADC_3_3V_HIGH: 3,3 V supply voltage too high.   |
| 2776 | 0x0AD8 | ADC_TEMP_LOW: Temperature too low. (ErrReg: 8)  |
| 2777 | 0x0AD9 | ADC_TEMP_HIGH: Temperature too high. (ErrReg: 8)  |
| 2778 | 0x0ADA | ADC_CURR_HIGH: Total output current too high. (ErrReg: 2)   |
| 2780 | 0x0ADC | ADC_SYSTEMP_ERR: Temperature measurement inconsistent at MC 1 and MC 2.<br>(Possible cause: ground fault / short circuit at the output) |
| 2782 | 0x0ADE | ADC_RANGE_ERR: AD Range error.  |
| 2816 | 0x0B00 | BUSY_WAITING: Busy waiting  |
| 3073 | 0x0C01 | TH_TIMEOUT: Internal test sequence timeout  |
| 3088 | 0x0C10 | MC1_ID_INVALID: Identification of MC 1 failed   |
| 3089 | 0x0C11 | MC2_ID_INVALID: Identification of MC 2 failed   |
| 3090 | 0x0C12 | MC3_ID_INVALID: Identification of MC 3 failed   |
| 3104 | 0x0C20 | CLK_ERROR: Partner clock frequency is out of valid range  |
| 3105 | 0x0C21 | CLK_PARTNER_LOW: Partner clock frequency is below lower limit   |
| 3106 | 0x0C22 | CLK_PARTNER_HIGH: Partner clock frequency is above upper limit  |

| <b>Id</b>   | <b>Hex</b> | <b>Explanation</b>  |
|-------------|------------|---|
| <b>3120</b> | 0x0C30     | HW_REVISION_ERROR: Invalid HW revision detected (the SW currently running is not designed for this HW revision) |
| <b>3232</b> | 0x0CA0     | XCOM_NOTREADY: Communication to safety partner MC not ready / operational                                       |
| <b>3233</b> | 0x0CA1     | XCOM_BUSY: Communication to safety partner is busy  |
| <b>3234</b> | 0x0CA2     | XCOM_NONEWDATA: No new data received from EC master.  |
| <b>3235</b> | 0x0CA3     | XCOM_CRCERR: Communication to safety partner detected a CRC error   |
| <b>3236</b> | 0x0CA4     | XCOM_BITERR: Bit (shift) error detected in communication to partner MC.   |
| <b>3237</b> | 0x0CA5     | XCOM_TRANSACT_ERR: '\$Transaction numbers not equal\$' error detected in communication to partner MC.           |
| <b>3298</b> | 0x0CE2     | ECAT_NONEWDATA: No new data received from safety partner MC.  |
| <b>3329</b> | 0x0D01     | OUT_OF_RANGE_ERR: Parameter or value out of allowed range.  |
| <b>3330</b> | 0x0D02     | OVERWRITE_ERR: Register buffer data overwrite occurred.   |
| <b>3344</b> | 0x0D10     | DIPSW_READERR: DIP switch could not be read   |
| <b>3345</b> | 0x0D11     | DIPSW_IDINV: XCom id not valid -> XCom out of sync ?  |
| <b>3346</b> | 0x0D12     | DIPSW_CHANGED: DIP switch setting changed   |
| <b>3347</b> | 0x0D13     | DIPSW_XCHGERROR: Exchange of address DIP settings failed  |
| <b>3354</b> | 0x0D1A     | DPSW_ADDRINV: Invalid FSoE address selected (ErrReg: 32)  |
| <b>3355</b> | 0x0D1C     | DIPSW_CMDINV: XCom command not valid -> XCom out of sync ?  |
| <b>3585</b> | 0x0E01     | ERROR_LINE_DETECTED: Error line set by other MC   |
| <b>3600</b> | 0x0E10     | FGTSK_ASYNC_ERROR: ForeGround tasks out of sync   |
| <b>3873</b> | 0x0F21     | FLASH_TIMEOUT: FLASH operation timeout  |
| <b>3874</b> | 0x0F22     | FLASH_LOCKED: FLASH operation failed because '\$LOCK\$' bit could not be reset                                  |
| <b>3883</b> | 0x0F2B     | FLASH_BUSY: FLASH operation busy  |
| <b>3886</b> | 0x0F2E     | FLASH_ERROR: FLASH operation error  |
| <b>3920</b> | 0x0F50     | FSOE_RESET_IND: Received FSoE reset indication (ErrReg: 16)   |
| <b>3921</b> | 0x0F51     | FSOE_INVALID_CMD: Received invalid or out of sequence FSoE command (ErrReg: 16)                                 |
| <b>3922</b> | 0x0F52     | FSOE_UNKNOWN_CMD: (ErrReg: 16)  |
| <b>3923</b> | 0x0F53     | FSOE_INVALID_CONNID: FSoE frame contains invalid connection id (ErrReg: 16)                                     |
| <b>3924</b> | 0x0F54     | FSOE_INVALID_CRC: FSoE frame contains invalid CRC (ErrReg: 16)  |
| <b>3925</b> | 0x0F55     | FSOE_WD_EXPIRED: FSoE watchdog timer expired (ErrReg: 16)   |
| <b>3926</b> | 0x0F56     | FSOE_INVALID_ADDRESS: FSoE address set on DIP and as safe parameter are not identical (ErrReg: 16)              |
| <b>3927</b> | 0x0F57     | FSOE_INVALID_DATA: FSoE frame contains invalid data (ErrReg: 16)  |
| <b>3928</b> | 0x0F58     | FSOE_INVALID_COMMPARALEN: Invalid number of FSoE communication parameters (ErrReg: 16)                          |
| <b>3929</b> | 0x0F59     | FSOE_INVALID_COMMPARA: Received invalid FSoE communication parameter (ErrReg: 16)                               |
| <b>3930</b> | 0x0F5A     | FSOE_INVALID_USERPARALEN: Invalid number of FSoE user parameters (ErrReg: 16)                                   |
| <b>3931</b> | 0x0F5B     | FSOE_INVALID_USERPARA: Received invalid FSoE user parameter (ErrReg: 16)  |
| <b>4048</b> | 0x0FD0     | FSOE_INVALID_TP_INP_DURATION: Safety parameter input test pulse duration invalid (ErrReg: 16)                   |



| Id   | Hex    | Explanation  |
|------|--------|--|
| 4049 | 0x0FD1 | FSOE_INVALID_TP_INP_FREQUENCY: Safety parameter input test pulse frequency invalid (ErrReg: 16)                        |
| 4050 | 0x0FD2 | FSOE_INVALID_TP_OUT_DURATION: Safety parameter output test pulse duration invalid (ErrReg: 16)                         |
| 4051 | 0x0FD3 | FSOE_INVALID_TP_OUT_FREQUENCY: Safety parameter output test pulse frequency invalid (ErrReg: 16)                       |
| 4056 | 0x0FD8 | FSOE_INVALID_WATCHDOG_TIME: Safety parameter watchdog time invalid (ErrReg: 16)  |
| 4057 | 0x0FD9 | FSOE_INVALID_INP_EXT_SUPPLY: Safety parameter for inputs having external supply invalid (ErrReg: 16)                   |
| 4058 | 0x0FDA | FSOE_INVALID_INP_IN_USE: Safety parameter for inputs in use invalid (ErrReg: 16)                                       |
| 4059 | 0x0FDB | FSOE_INVALID_INP_USED_EXT_MISMATCH: Safety parameters for inputs in use and externally supplied mismatch (ErrReg: 16)  |
| 4060 | 0x0FDC | FSOE_INVALID_OUT_IN_USE: Safety parameter for outputs in use invalid (ErrReg: 16)                                      |
| 4061 | 0x0FDD | FSOE_INVALID_OUT_USED_EXT_MISMATCH: Safety parameters for outputs in use and externally grounded mismatch (ErrReg: 16) |
| 4064 | 0x0FE0 | FSOE_ERROR: Invalid internal state in safety stack   |

### 8.1.14 Err.pos 2008<sub>h</sub> for $\mu$ C1 and 2018<sub>h</sub> for $\mu$ C2

|                        |                   |
|------------------------|-------------------|
| <b>Name</b>            | Err.pos CPU 1/2   |
| <b>Index</b>           | 2008 <sub>h</sub> |
| <b>Object Code</b>     | VARIABLE          |
| <b>No. of Elements</b> | 0                 |
| <b>Data Type</b>       | UNSIGNED16        |
| <b>Access</b>          | Read only         |
| <b>PDO Mapping</b>     | No                |
| <b>Default Value</b>   | 0000 <sub>h</sub> |

### 8.1.15 Err.module 2009<sub>h</sub> for $\mu$ C1 and 2019<sub>h</sub> for $\mu$ C2

|                        |                    |
|------------------------|--------------------|
| <b>Name</b>            | Err.module CPU 1/2 |
| <b>Index</b>           | 2009 <sub>h</sub>  |
| <b>Object Code</b>     | VARIABLE           |
| <b>No. of Elements</b> | 0                  |
| <b>Data Type</b>       | UNSIGNED8          |
| <b>Access</b>          | Read only          |
| <b>PDO Mapping</b>     | No                 |
| <b>Default Value</b>   | 00 <sub>h</sub>    |

The table below explains the entries in object 2009<sub>h</sub> or 2019<sub>h</sub> "Err.module".

| Id | Explanation                     |
|----|---------------------------------|
| 0  | OBJ_UNKNOWN_ID – unknown module |
| 4  | OBJ_FSOETASK_ID - CFSOETask.cpp |
| 8  | OBJ_INPUT_ID - CInput.cpp       |

|     |  |
|-----|--|
| 12  | OBJ_MAINTASK_ID - CMainTask.cpp                      |
| 16  | OBJ_LOGGER_ID - CLogger.cpp                          |
| 20  | OBJ_SYNCSAFETYPARTNER_ID -<br>CSyncSafetyPartner.cpp |
| 24  | OBJ_XCOM_ID - CXCom.cpp                              |
| 26  | OBJ_SAFEDATAEXCHG_ID - CSafedataExchange.cpp         |
| 28  | OBJ_SAFETYHAL_ID - CSafetyHal.cpp                    |
| 32  | OBJ_USTIMER_ID - CusTimer.cpp                        |
| 36  | OBJ_MSTIMER_ID - CmsTimer.cpp                        |
| 40  | OBJ_MICROCONTROLLER_ID - CMicrocontroller.cpp        |
| 48  | OBJ_DIPSWITCH_ID - CDIPSwitch.cpp                    |
| 52  | OBJ_HELPER_ID - CHelper.cpp                          |
| 56  | OBJ_SYNCLINE_ID - CSyncSafetyPartner.cpp             |
| 60  | OBJ_TIMETABLE_ID - CTimeTableManager.cpp             |
| 64  | OBJ_TESTHANDLER_ID - CTestHandler.cpp                |
| 68  | OBJ_CLOCKTEST_ID - CClockTest.cpp                    |
| 72  | OBJ_TEMPSENSOR_ID - CTempSensor.cpp                  |
| 80  | OBJ_TIME_ITERATOR_ID - CTimeTableIterator.cpp        |
| 84  | OBJ_INTHANDLER_ID - InterruptHandler.cpp             |
| 85  | OBJ_FOREGROUND_ID - CForeground.cpp                  |
| 86  | OBJ_BACKGROUND_ID - CBackGround.cpp                  |
| 87  | OBJ_CONFIG_ID - CConfig.cpp                          |
| 88  | OBJ_MATMNGR_ID - CMatMngr.cpp                        |
| 89  | OBJ_SWITMNGR_ID - CSwitMngr.cpp                      |
| 96  | OBJ_SPI_ID - CSpi.cpp                                |
| 97  | OBJ_TIMER_ID - CTimer.cpp                            |
| 98  | OBJ_BACKUPSRAM_ID - CBackupSRam.cpp                  |
| 99  | OBJ_PWR_ID - CPwr.cpp                                |
| 100 | OBJ_RCC_ID - CRcc.cpp                                |
| 101 | OBJ_GPIO_ID - OBJ_GPIO_ID                            |
| 102 | OBJ_DMA_ID - CDma.cpp                                |
| 103 | OBJ_ADC_ID - CAdc.cpp                                |
| 104 | OBJ_WD_ID - CWatchdog.cpp                            |
| 105 | OBJ_FLASH_ID - CFlash.cpp                            |
| 106 | OBJ_I2C_ID - CI2c.cpp                                |
| 107 | OBJ_MRAM_ID - CMRam.cpp                              |
| 109 | OBJ_EXTI_ID - CExtI.cpp                              |
| 110 | OBJ_SYSCFG_ID - CSyscfg.cpp                          |
| 111 | OBJ_NVIC_ID - CNvic.cpp                              |
| 112 | OBJ_RNG_ID - CRng.cpp                                |
| 114 | OBJ_FLASHPRG_ID - CFlashProgram.cpp                  |
| 120 | OBJ_VOLTCHECK_ID - CVoltageCheck.cpp                 |
| 121 | OBJ_VOLTMEANCHECK_ID - CVoltageMeanCheck.cpp         |
| 122 | OBJ_SUPLVOLTCHECK_ID - CSupplyVoltageCheck.cpp       |
| 124 | OBJ_DIAG_ID - CDiagnostic.cpp                        |
| 126 | OBJ_MPUUNPRIV_ID - CMpuUnpriv.cpp                    |
| 127 | OBJ_MPUPRIV_ID - CMpuPriv.cpp                        |

|     |  |
|-----|--|
| 128 | OBJ_INPUTMNGR_ID - CInputMngr.cpp              |
| 129 | OBJ_INPUTMNGR_ID - CInputMngr.cpp (Safe-In 1)  |
| 130 | OBJ_INPUTMNGR_ID - CInputMngr.cpp (Safe-In 2)  |
| 131 | OBJ_INPUTMNGR_ID - CInputMngr.cpp (Safe-In 3)  |
| 132 | OBJ_INPUTMNGR_ID - CInputMngr.cpp (Safe-In 4)  |
| 133 | OBJ_INPUTMNGR_ID - CInputMngr.cpp (Safe-In 5)  |
| 134 | OBJ_INPUTMNGR_ID - CInputMngr.cpp (Safe-In 6)  |
| 135 | OBJ_INPUTMNGR_ID - CInputMngr.cpp (Safe-In 7)  |
| 136 | OBJ_INPUTMNGR_ID - CInputMngr.cpp (Safe-In 8)  |
| 137 | OBJ_INPUTMNGR_ID - CInputMngr.cpp (Safe-In 9)  |
| 138 | OBJ_INPUTMNGR_ID - CInputMngr.cpp (Safe-In 10) |
| 139 | OBJ_INPUTMNGR_ID - CInputMngr.cpp (Safe-In 11) |
| 140 | OBJ_INPUTMNGR_ID - CInputMngr.cpp (Safe-In 12) |
| 141 | OBJ_INPUTMNGR_ID - CInputMngr.cpp (Safe-In 13) |
| 142 | OBJ_INPUTMNGR_ID - CInputMngr.cpp (Safe-In 14) |
| 143 | OBJ_INPUTMNGR_ID - CInputMngr.cpp (Safe-In 15) |
| 144 | OBJ_INPUTMNGR_ID - CInputMngr.cpp (Safe-In 16) |
| 160 | OBJ_OUTPUTMNGR_ID - COutputMngr.cpp            |
| 164 | OBJ_OUTPUT_USLS_ID - COutput_USLS.cpp          |
| 176 | OBJ_BBMAIN_ID - CBBMainTask.cpp                |
| 178 | OBJ_ECATAPIF_ID - ECatApplInterface.cpp        |
| 180 | OBJ_BBDIAG_ID - CBBDiagnostic.cpp              |
| 184 | OBJ_BBHAL_ID - CBaseBoardHal.cpp               |
| 192 | OBJ_IO_TSK_ID - CIO_TaskHandler.cpp            |
| 196 | OBJ_GLERRHDL_ID - CGlobalError.cpp             |
| 200 | OBJ_ERRHDLR_ID - CErrorHandler.cpp             |
| 219 | OBJ_DBGLEDS_ID - CDebugLEDs.cpp                |
| 224 | OBJ_ECATSLV_ID - ecatslv.cpp                   |

### 8.1.16 Err.class 200A<sub>h</sub> for $\mu$ C1 and 201A<sub>h</sub> for $\mu$ C2

|                        |                   |
|------------------------|-------------------|
| <b>Name</b>            | Err.class CPU 1/2 |
| <b>Index</b>           | 200A <sub>h</sub> |
| <b>Object Code</b>     | VARIABLE          |
| <b>No. of Elements</b> | 0                 |
| <b>Data Type</b>       | UNSIGNED8         |
| <b>Access</b>          | Read only         |
| <b>PDO Mapping</b>     | No                |
| <b>Default Value</b>   | 00 <sub>h</sub>   |

The table below explains the entries in object 200A<sub>h</sub> or 201A<sub>h</sub> "Err.class".

| <b>Id</b> | <b>Explanation</b>  |
|-----------|---|
| <b>0</b>  | No error  |
| <b>1</b>  | Internal, communication, synchronisation, parameter, TP, FB error |
| <b>2</b>  | Test handler error (BIST)   |

|          |                                  |
|----------|----------------------------------|
| <b>3</b> | External, I/O error (resettable) |
|----------|----------------------------------|

### 8.1.17 System Uptime [s] 200C<sub>h</sub>

|                        |                   |
|------------------------|-------------------|
| <b>Name</b>            | System Uptime     |
| <b>Index</b>           | 200C <sub>h</sub> |
| <b>Object Code</b>     | VARIABLE          |
| <b>No. of Elements</b> | 0                 |
| <b>Data Type</b>       | UNSIGNED32        |
| <b>Access</b>          | Read only         |
| <b>PDO Mapping</b>     | No                |
| <b>Unit</b>            | s                 |
| <b>Default Value</b>   | No default value  |

### 8.1.18 ADC RefVoltage 2010<sub>h</sub>

|                        |                   |
|------------------------|-------------------|
| <b>Name</b>            | ADC RefVoltage    |
| <b>Index</b>           | 2010 <sub>h</sub> |
| <b>Object Code</b>     | VARIABLE          |
| <b>No. of Elements</b> | 0                 |
| <b>Data Type</b>       | UNSIGNED16        |
| <b>Access</b>          | Read only         |
| <b>PDO Mapping</b>     | No                |
| <b>Unit</b>            | ??                |
| <b>Default Value</b>   | No default value  |

### 8.1.19 Ext. Temperature MC1 0x2016<sub>h</sub>

|                        |                      |
|------------------------|----------------------|
| <b>Name</b>            | Ext. Temperature MC1 |
| <b>Index</b>           | 2016 <sub>h</sub>    |
| <b>Object Code</b>     | VARIABLE             |
| <b>No. of Elements</b> | 0                    |
| <b>Data Type</b>       | UNSIGNED32           |
| <b>Access</b>          | Read only            |
| <b>PDO Mapping</b>     | No                   |
| <b>Unit</b>            | 0.1°C                |
| <b>Default Value</b>   | No default value     |

### 8.1.20 MaxAsicDataUnequalCounter 0x2020<sub>h</sub>

|                        |                           |
|------------------------|---------------------------|
| <b>Name</b>            | MaxAsicDataUnequalCounter |
| <b>Index</b>           | 2020 <sub>h</sub>         |
| <b>Object Code</b>     | VARIABLE                  |
| <b>No. of Elements</b> | 0                         |

|                      |   |
|----------------------|---|
| <b>Data Type</b>     | UNSIGNED8   |
| <b>Access</b>        | Read only   |
| <b>PDO Mapping</b>   | No  |
| <b>Value</b>         | Number of times EtherCAT ASIC read out errors were detected |
| <b>Default Value</b> | 00  |

### 8.1.21 Temperature Warning 0x2026<sub>h</sub>

|                        |                                       |
|------------------------|---------------------------------------|
| <b>Name</b>            | Temperature Warning                   |
| <b>Index</b>           | 2026 <sub>h</sub>                     |
| <b>Object Code</b>     | VARIABLE                              |
| <b>No. of Elements</b> | 0                                     |
| <b>Data Type</b>       | UNSIGNED8                             |
| <b>Access</b>          | Read only                             |
| <b>PDO Mapping</b>     | No                                    |
| <b>Value</b>           | 5 °C – 50 °C = 0; <5° C or >50 °C = 1 |
| <b>Default Value</b>   | No default value                      |

### 8.1.22 Safe State 0x2055<sub>h</sub>

|                        |   |
|------------------------|---|
| <b>Name</b>            | Safe State                                      |
| <b>Index</b>           | 2055 <sub>h</sub>                               |
| <b>Object Code</b>     | VARIABLE  |
| <b>No. of Elements</b> | 0   |
| <b>Data Type</b>       | UNSIGNED8                                       |
| <b>Access</b>          | Read only                                       |
| <b>PDO Mapping</b>     | No  |
| <b>Value</b>           | 0xF0 (functional operating) – 0x55 (safe state) |
| <b>Default Value</b>   | No default value                                |

### 8.1.23 Fail Safe Command 0x250E<sub>h</sub>

|                        |                   |
|------------------------|-------------------|
| <b>Name</b>            | Fail Safe Command |
| <b>Index</b>           | 250E <sub>h</sub> |
| <b>Object Code</b>     | VARIABLE          |
| <b>No. of Elements</b> | 3                 |
| <b>Data Type</b>       | IDENTITY          |
| <b>BitSize</b>         | 32                |

|                      |                 |
|----------------------|-----------------|
| <b>Name</b>          | Subindex 000    |
| <b>Subindex</b>      | 00 <sub>h</sub> |
| <b>Data Type</b>     | UNSIGNED8       |
| <b>Access</b>        | Read only       |
| <b>PDO Mapping</b>   | No              |
| <b>Default Value</b> | >2<             |

|                      |  |
|----------------------|--|
| <b>Name</b>          | Rx-FSoE-Cmd  |
| <b>Subindex</b>      | 01 <sub>h</sub>  |
| <b>Data Type</b>     | UNSIGNED8  |
| <b>Access</b>        | Read only  |
| <b>PDO Mapping</b>   | Tx PDO   |
| <b>Value</b>         | <ul style="list-style-type: none"> <li>0 Undefined</li> <li>8 Fail Safe Data</li> <li>42 Reset</li> <li>54 Data</li> <li>78 Session</li> <li>82 Parameter</li> <li>100 Connection</li> </ul> |
| <b>Default Value</b> | No default value   |

|                      |  |
|----------------------|--|
| <b>Name</b>          | Tx-FSoE-Cmd  |
| <b>Subindex</b>      | 02 <sub>h</sub>  |
| <b>Data Type</b>     | UNSIGNED8  |
| <b>Access</b>        | Read only  |
| <b>PDO Mapping</b>   | Tx PDO   |
| <b>Value</b>         | <ul style="list-style-type: none"> <li>0 Undefined</li> <li>8 Fail Safe Data</li> <li>42 Reset</li> <li>54 Data</li> <li>78 Session</li> <li>82 Parameter</li> <li>100 Connection</li> </ul> |
| <b>Default Value</b> | No default value   |

## 8.2 Standards Complied With

### 8.2.1 Product Standard Applied

- EN 61131-2:2008-04  
Programmable logic controllers – Part 2: Equipment requirements and tests

### 8.2.2 Safety Standards and Directives

- IEC 61508:2011-02 Parts 1-7  
Functional safety of electrical/electronic/programmable electronic safety-related systems
- EN ISO 13849-1:2016-06  
Safety of machinery – Safety-related parts of control systems  
Part 1: General principles for design
- EN 62061:2016-05  
Safety of machinery - Functional safety of electrical, electronic and programmable electronic safety-related control systems

### 8.2.3 EMC Standards

#### EMC immunity to:

- Generic standard DIN EN 61000-6-2:2006-03  
Electromagnetic compatibility (EMC) – Part 6-2: Generic standards - Immunity for industrial environments
- Product standard DIN EN 61131-2:2008-04  
Programmable logic controllers – Part 2: Equipment requirements and tests

#### Increased EMC immunity levels for safety-related applications:

For the testing of Kuhnke FIO I/O modules, the following three standards for safety-related applications were considered. The interfaces were tested with the highest test levels from the standards.

- Product standard DIN EN 61131-6:2013-10  
Programmable logic controllers - Part 6: Functional safety
- Product standard DIN EN 61326-3-1:2018-04  
Electrical equipment for measurement, control, and laboratory use - EMC requirements - Part 3-1: Immunity requirements for safety-related systems and equipment intended for safety-related functions (functional safety) - General industrial applications
- Generic standard DIN EN 61000-6-7:2015-12  
Electromagnetic compatibility (EMC) - Part 6-7: Generic standards - Immunity requirements for equipment intended to perform functions in safety-related systems (functional safety) at industrial locations

#### EMC noise emission to:

- Generic standard DIN EN 61000-6-4:2011-09  
Electromagnetic compatibility (EMC) – Part 6-4: Generic standards – Emission standard for industrial environments
- Product standard EN 61131-2:2008-04  
Programmable logic controllers – Part 2: Equipment requirements and tests

## 8.3 Regulations and Declarations

### 8.3.1 Mark of Conformity

The original EC-Declaration of Conformity and the associated documentation can be made available to the competent authorities. Please contact the Project Management, as necessary.

SDI8 SDO2:

|  |  |   |
|--|--|---|
| <b>KENDRION</b>  |  | <b>PRECISION. SAFETY. MOTION.</b>   |
|  |  | Kendrion Kuhnke Automation GmbH<br>Lütjenburger Straße 101<br>23714 Malente<br>Deutschland<br>T +49 4523 402-0<br>F +49 4523 402-201  |
| <b>Konformitätserklärung<br/>Declaration of Conformity</b>   |  |   |
| Wir erklären, dass das nachfolgend bezeichnete Produkt den Bestimmungen der unten markierten EG- Richtlinien entspricht.   |  |   |
| We declare that the following named product conforms with the requirements of the below marked EEC Directives.   |  |   |
| Bezeichnung/<br>Description  | Kuhnke FIO Safety SDI8 SDO2  |   |
| Typ/<br>Type   | Best.-Nr. 694 430 10   |   |
| Kendrion Kuhnke Ident-Nr./<br>Kendrion Kuhnke identification number  | 188895   |   |
| Angewandte Normen/<br>Considered standards   | EN 61131-2:2007,<br>IEC 61508:2010 Teile 1-7   |   |
| Angewandte harmonisierte Normen (MRL)/<br>Considered harmonized standards (MD)   | EN ISO 13849-1:2015,<br>EN 62061:2005 + AC:2010 + A1;2013 + A2;2015  |   |
| Benannte Stelle (bezgl. MRL 2006/42/EG)/<br>Notified Bodies  | TÜV Rheinland Industrie Service GmbH<br>Am Grauen Stein<br>51105 Köln / Germany<br>Tel.: +49 221 806-2434,<br>Fax: +49 221 806-1354,<br>E-Mail: <a href="mailto:hcmd.schreiber@de.tuv.com">hcmd.schreiber@de.tuv.com</a><br>NB-Nr.: 0035 |   |
| Berücksichtigte EG-Richtlinie:<br>Considered EEC-Directives:   |  |   |
| <input checked="" type="checkbox"/>  | 2014/30/EU   | Elektromagnetische Verträglichkeit EMV /<br>Electromagnetic compatibility EMC   |
| <input checked="" type="checkbox"/>  | 2011/65/EU   | Beschränkung der Verwendung bestimmter gefährlicher Stoffe in Elektro- und Elektronikgeräten (RoHS-3) /<br>Restriction of the use of certain hazardous substances in electrical and electronic equipment (RoHS-3) |
| <input checked="" type="checkbox"/>  | 2006/42/EG   | Maschinenrichtlinie, Baumusterbescheinigung (01/205/5758.00/20) /<br>Machinery Directive, EC Type-Examination Certificate (01/205/5758.00/20)   |
| Wird das Produkt in eine Maschine eingebaut oder mit anderen Maschinen zu einer Maschine zusammengebaut, so ist vor der Inbetriebnahme zu prüfen, ob die Maschine, in dieses Produkt eingebaut werden soll, den Bestimmungen der Richtlinien entspricht. |  |   |
| If the device is mounted in a machine or assemblies with other machinery to constitute a machine in front of the operation of the machine it is necessary to test that the machine itself conforms with the requirements of the directive.               |  |   |
| Malente, 13.01.2020  |  |   |
| Ort, Datum<br>Place, date of issue   |  | Entwicklungsleiter/<br>Development Manager  |
| KE-0106/0212   |  | Seite 1 von 1   |



SDI16 SDO4:

**KENDRION**

PRECISION. SAFETY. MOTION.

Kendrion Kuhnke Automation GmbH

Lügerburger Straße 101  
23714 Malente  
Deutschland  
T +49 4523 402-0  
F +49 4523 402-201

## Konformitätserklärung Declaration of Conformity

Wir erklären, dass das nachfolgend bezeichnete Produkt den Bestimmungen der unten markierten EG- Richtlinien entspricht.

We declare that the following named product conforms with the requirements of the below marked EEC Directives.

|  |  |
|--|--|
| Bezeichnung/<br>Description  | Kuhnke FIO Safety SDI16 SDO4   |
| Typ/<br>Type   | Best.-Nr. 694 430 20   |
| Kendrion Kuhnke Ident-Nr./<br>Kendrion Kuhnke identification number            | 192405   |
| Angewandte Normen/<br>Considered standards                                     | EN 61131-2:2007,<br>IEC 61508:2010 Teile 1-7   |
| Angewandte harmonisierte Normen (MRL)/<br>Considered harmonized standards (MD) | EN ISO 13849-1:2015,<br>EN 62061:2005 + AC:2010 + A1:2013 + A2:2015  |
| Benannte Stelle (bezgl. MRL 2006/42/EG)/<br>Notified Bodies                    | TÜV Rheinland Industrie Service GmbH<br>Am Grauen Stein<br>51105 Köln / Germany<br>Tel.: +49 221 806-2434,<br>Fax: +49 221 806-1354,<br>E-Mail: <a href="mailto:bo.md.schreiber@de.tuv.com">bo.md.schreiber@de.tuv.com</a><br>NB-Nr.: 0035 |

Berücksichtigte EG-Richtlinie:  
Considered EEC-Directives:

- 2014/30/EU Elektromagnetische Verträglichkeit EMV /  
Electromagnetic compatibility EMC
- 2011/65/EU Beschränkung der Verwendung bestimmter gefährlicher Stoffe in Elektro- und Elektronikgeräten (RoHS-3) /  
Restriction of the use of certain hazardous substances in electrical and electronic equipment (RoHS-3)
- 2006/42/EG Maschinenrichtlinie, Baumusterbescheinigung (01/205/5758.00/20) /  
Machinery Directive, EC Type-Examination Certificate (01/205/5758.00/20)

Wird das Produkt in eine Maschine eingebaut oder mit anderen Maschinen zu einer Maschine zusammengebaut, so ist vor der Inbetriebnahme zu prüfen, ob die Maschine, in dieses Produkt eingebaut werden soll, den Bestimmungen der Richtlinien entspricht.

If the device is mounted in a machine or assembles with other machinery to constitute a machine in front of the operation of the machine it is necessary to test that the machine itself conforms with the requirements of the directive.

Malente, 13.01.2020

Ort, Datum  
Place, date of issuei.v.   
Entwicklungsleiter/  
Development Manager

SDI16:

|  |  |   |
|--|--|---|
| <b>KENDRION</b>  |  | <b>PRECISION. SAFETY. MOTION.</b>   |
|  |  | <b>Kendrion Kuhnke Automation GmbH</b><br>Lützenburger Straße 101<br>23714 Malente<br>Deutschland<br>T +49 4523 402-0<br>F +49 4523 402-201   |
| <b>Konformitätserklärung</b><br><b>Declaration of Conformity</b>   |  |   |
| Wir erklären, dass das nachfolgend bezeichnete Produkt den Bestimmungen der unten markierten EG- Richtlinien entspricht.   |  |   |
| We declare that the following named product conforms with the requirements of the below marked EEC Directives.   |  |   |
| Bezeichnung/<br>Description  | Kuhnke FIO Safety SDI16  |   |
| Typ/<br>Type   | Best.-Nr. 694 431 00   |   |
| Kendrion Kuhnke Ident-Nr./<br>Kendrion Kuhnke identification number  | 192406   |   |
| Angewandte Normen/<br>Considered standards   | EN 61131-2:2007,<br>IEC 61508:2010 Teile 1-7   |   |
| Angewandte harmonisierte Normen (MRL)/<br>Considered harmonized standards (MD)   | EN ISO 13849-1:2015,<br>EN 62061:2005 + AC:2010 + A1:2013 + A2:2015  |   |
| Benannte Stelle (bezgl. MRL 2006/42/EG)<br>Notified Bodies   | TÜV Rheinland Industrie Service GmbH<br>Am Grauen Stein<br>51105 Köln / Germany<br>Tel.: +49 221 806-2434,<br>Fax: +49 221 806-1354,<br>E-Mail: <a href="mailto:bernd.schreiber@de.tuv.com">bernd.schreiber@de.tuv.com</a><br>NB-Nr.: 0035 |   |
| Berücksichtigte EG-Richtlinie:<br>Considered EEC-Directives:   |  |   |
| <input checked="" type="checkbox"/>  | 2014/30/EU   | Elektromagnetische Verträglichkeit EMV /<br>Electromagnetic compatibility EMC   |
| <input checked="" type="checkbox"/>  | 2011/65/EU   | Beschränkung der Verwendung bestimmter gefährlicher Stoffe in Elektro- und Elektronikgeräten (RoHS-3) /<br>Restriction of the use of certain hazardous substances in electrical and electronic equipment (RoHS-3) |
| <input checked="" type="checkbox"/>  | 2006/42/EG   | Maschinenrichtlinie, Baumusterbescheinigung (01/205/5758.00/20) /<br>Machinery Directive, EC Type-Examination Certificate (01/205/5758.00/20)   |
| Wird das Produkt in eine Maschine eingebaut oder mit anderen Maschinen zu einer Maschine zusammengebaut, so ist vor der Inbetriebnahme zu prüfen, ob die Maschine, in dieses Produkt eingebaut werden soll, den Bestimmungen der Richtlinien entspricht. |  |   |
| If the device is mounted in a machine or assembles with other machinery to constitute a machine in front of the operation of the machine it is necessary to test that the machine itself conforms with the requirements of the directive.                |  |   |
| Malente, 13.01.2020  |    |   |
| Ort, Datum<br>Place, date of issue   | Entwicklungsleiter/<br>Development Manager   |   |

## 8.3.2 TÜV Certificates

## EC Type-Examination Certificate





Product Safety  
Functional  
Safety

www.tuv.com  
ID 060000000

Reg.-Nr./No.: 01/205/5758.00/20

|   |   |  |  |
|---|---|--|--|
| <b>Prüfgegenstand</b><br>Product tested                     | Sichere digitale Ein-/Ausgangsbaugruppen mit sicherer Kommunikation über FSoE<br>Safe digital I/O modules with safety communication FSoE  | <b>Zertifikatsinhaber</b><br>Certificate holder  | Kendrion Kuhnke Automation GmbH<br>Lütjenburger Str. 101<br>23714 Malente<br>Germany |
| <b>Typbezeichnung</b><br>Type designation                   | Kuhnke FIO Safety SDI16 SDO4 - 694 430 20<br>Kuhnke FIO Safety SDI8 SDO2 - 694 430 10<br>Kuhnke FIO Safety SDI16 - 694 431 00<br>See revision list for details.   |  |  |
| <b>Prüfgrundlagen</b><br>Codes and standards                | EN ISO 13849-1:2015<br>EN 62061:2005 + AC:2010 + A1:2013 + A2:2015<br>IEC 61508 Parts 1-7:2010  | EN 61131-2:2007<br>EN 60204-1:2018 (in extracts) |  |
| <b>Bestimmungsgemäße Verwendung</b><br>Intended application | Die Geräte erfüllen die Anforderungen der Prüfgrundlagen (Kat. 4 / PL e nach EN ISO 13849-1, SIL CL 3 nach EN 62061, SIL 3 nach IEC 61508) und können in Anwendungen bis zu diesen Sicherheitsleveln eingesetzt werden. Das Produkt wurde auch in Bezug auf die Anforderungen der EN 60204-1:2018 überprüft und kann in solchen Anwendungen verwendet werden.<br>The devices comply with the requirements of the relevant standards (Cat. 4 / PL e according to EN ISO 13849-1, SIL CL 3 according to EN 62061, SIL 3 according to IEC 61508) and can be used in applications up these safety levels. The product was also reviewed in reference to the requirements of EN 60204-1:2018 and can be used in such applications. |  |  |
| <b>Besondere Bedingungen</b><br>Specific requirements       | Die Hinweise in der zugehörigen Installations- und Betriebsanleitung sowie des Sicherheitshandbuchs sind zu beachten.<br>The instructions of the associated Installation, Operating and Safety Manual shall be considered.  |  |  |

Es wird bestätigt, dass der Prüfgegenstand mit den Anforderungen nach Anhang I der Richtlinie 2006/42/EG über Maschinen übereinstimmt.  
It is confirmed, that the product tested complies with the requirements for machines defined in Annex I of the EC Directive 2006/42/EC.

Gültig bis / Valid until 2025-02-18

Der Ausstellung dieses Zertifikates liegt eine Prüfung zugrunde, deren Ergebnisse im Bericht Nr. 968/FSP 2000.00/20 vom 18.02.2020 dokumentiert sind.  
Dieses Zertifikat ist nur gültig für Erzeugnisse, die mit dem Prüfgegenstand übereinstimmen.  
The issue of this certificate is based upon an examination, whose results are documented in Report No. 968/FSP 2000.00/20 dated 2020-02-18.  
This certificate is valid only for products which are identical with the product tested.



Köln, 2020-02-18

Notified Body for Machinery, NB 0035



Dipl.-Ing. Eberhard Frejno

TÜV Rheinland Industrie Service GmbH, Am Grauen Stein, 51105 Köln / Germany  
Tel: +49 221 806-2434, Fax: +49 221 806-1354, E-Mail: industrie\_senfad@de.tuv.com

www.fs-products.com  
www.tuv.com

 **TÜVRheinland**<sup>®</sup>  
Precisely Right.

SDI8 SDO2:

# ATTESTATION



## FSoE CONFORMANCE TESTED

on the basis of the agreement in the test and certification rules performed on 18.09.2019

### Company:

Kendrion Kuhnke Automation GmbH  
Lütjenburger Straße 101  
23710 Malente  
- Germany -

### Device under test:

Product name: Kuhnke FIO Safety SDI8 SDO2  
Product code: 0002ECC1  
Rev. number: 00000008  
Vendor ID: 0x0048554B

The device has been tested by  
TUV SÜD Rail GmbH according to the following  
test specification:

|                              |          |
|------------------------------|----------|
| FSoE Conformance Test Tool:  | V2.1.0.0 |
| FSoE.dll:                    | V1.3.0.0 |
| TestLibrary.dll:             | V1.1.0.0 |
| TF-2602 FSoE A Slave Test:   | V1.2.0.0 |
| TF-2603 FSoE M Slave Test:   | V1.2.0.0 |
| TF-2604 FSoE ALT Slave Test: | V1.2.0.0 |
| FSoE Protocol specification: | V1.2.0   |

The conformance test was conducted according to the instructions of TUV SÜD Rail GmbH. The requirements according FSoE conformance as stated in the test and certification rules are met.

Test report no.: KM94150T , rev. 1.0  
Test ID: 0x0048554B\_017

Munich, 18.09.2019

(Uwe Kremer, TR-RA-MUC)

SDI16 SDO4:

ATTESTATION  
 STATION  
 STATION



Rail

## FSoE CONFORMANCE TESTED

on the basis of the agreement in the test and certification rules performed on 18.09.2019

### Company:

Kendrion Kuhnke Automation GmbH  
 Lütjenburger Straße 101  
 23710 Malente  
 - Germany -

### Device under test:

Product name: Kuhnke FIO Safety SDI16 SDO4  
 Product code: 0002ECAD  
 Rev. number: 0000000A  
 Vendor ID: 0x0048554B

The device has been tested by  
 TÜV SÜD Rail GmbH according to the following  
 test specification:

|                              |          |
|------------------------------|----------|
| FSoE Conformance Test Tool:  | V2.1.0.0 |
| FSoE.dll:                    | V1.3.0.0 |
| TestLibrary.dll:             | V1.1.0.0 |
| TF-2602 FSoE A Slave Test:   | V1.2.0.0 |
| TF-2603 FSoE M Slave Test:   | V1.2.0.0 |
| TF-2604 FSoE ALT Slave Test: | V1.2.0.0 |
| FSoE Protocol specification: | V1.2.0   |

The conformance test was conducted according to the instructions of TÜV SÜD Rail GmbH. The requirements according FSoE conformance as stated in the test and certification rules are met.

Test report no.: KM94148T , rev. 1.1  
 Test ID: 0x0048554B\_015R1

Munich, 18.09.2019

(Uwe Kremer, TR-RA-MUC)

SDI16:

# ATTES STATION



## FSoE CONFORMANCE TESTED

on the basis of the agreement in the test and certification rules performed on 18.09.2019

### Company:

Kendrion Kuhnke Automation GmbH  
Lütjenburger Straße 101  
23710 Malente  
- Germany -

### Device under test:

Product name: Kuhnke FIO Safety SDI16  
Product code: 0002ECC2  
Rev. number: 00000008  
Vendor ID: 0x0048554B

The device has been tested by TUV SÜD Rail GmbH according to the following test specification:

|                              |          |
|------------------------------|----------|
| FSoE Conformance Test Tool:  | V2.1.0.0 |
| FSoE.dll:                    | V1.3.0.0 |
| TestLibrary.dll:             | V1.1.0.0 |
| TF-2602 FSoE A Slave Test:   | V1.2.0.0 |
| TF-2603 FSoE M Slave Test:   | V1.2.0.0 |
| TF-2604 FSoE ALT Slave Test: | V1.2.0.0 |
| FSoE Protocol specification: | V1.2.0   |

The conformance test was conducted according to the instructions of TUV SÜD Rail GmbH. The requirements according FSoE conformance as stated in the test and certification rules are met.

Test report no.: KM94149T , rev. 1.0  
Test ID: 0x0048554B\_016

Munich, 18.09.2019

A handwritten signature in blue ink, appearing to read 'Uwe Kremer'.

(Uwe Kremer, TR-RA-MUC)

TÜV SÜD Rail GmbH · FSoE Test Center · Barthstr. 16 · D-80339 München · Germany



## 8.4 Approvals

Kuhnke's FIO Safety I/O module has been granted the following permits:



Certified for use in safety application by the German technical testing and inspection association (TÜV) to: EN ISO 13849-1:2015, EN 62061:2005 + AC:2010 + A1:2013 + A2:2015, EN 61131-2:2007, IEC 61508 Parts 1-7:2010, EN 60204-1:2008 (in extracts)



CULUS  
File number: E202287



Conformance and interoperability tests passed at an EtherCAT Test Center (ETC).



FSoE Conformance Test passed.



Conforms to RoHS Directive 2011/65/EU limiting the use of certain hazardous substances in electrical and electronic equipment

## 8.5 Order Specifications

### 8.5.1 Basic Units

#### Technical Data

|  |                   |
|--|-------------------|
| <b>Kuhnke FIO Safety SDI4 SDO2</b>                                   | <b>694 430 00</b> |
| Safe input/output module   |                   |
| Safety protocol: FSoE  |                   |
| Safety standard: IEC 61508 SIL3 and DIN EN ISO 13849-1 Cat. 3 / PL e |                   |
| Number of inputs: 4 safe inputs (configurable properties)            |                   |
| Number of outputs: 2 safe outputs (I <sub>max</sub> = 2.0 A)         |                   |
| Test pulse outputs (OSSD): 4   |                   |
| Extended diagnostic information: Via CoE                             |                   |



#### Technical Data

|  |                   |
|--|-------------------|
| <b>Kuhnke FIO Safety SDI8 SDO2</b>                                   | <b>694 430 10</b> |
| Safe input/output module   |                   |
| Safety protocol: FSoE  |                   |
| Safety standard: IEC 61508 SIL3 and DIN EN ISO 13849-1 Cat. 4 / PL e |                   |
| Number of inputs: 8 safe inputs (configurable properties)            |                   |
| Number of outputs: 2 safe outputs (I <sub>max</sub> = 0.5 A)         |                   |
| Test pulse outputs (OSSD): 4   |                   |
| Extended diagnostic information: Via CoE                             |                   |



#### Technical Data

|                                     |                   |
|-------------------------------------|-------------------|
| <b>Kuhnke FIO Safety SDI16 SDO4</b> | <b>694 430 20</b> |
|-------------------------------------|-------------------|

Safe input/output module  
 Safety protocol: FSoE  
 Safety standard: IEC 61508 SIL3 and DIN EN ISO 13849-1 Cat. 4 / PL e  
 Number of inputs: 16 safe inputs (configurable properties)  
 Number of outputs: 4 safe outputs ( $I_{max} = 0.5 \text{ A}$ )  
 Test pulse outputs (OSSD): 8  
 Extended diagnostic information: Via CoE



#### Technical Data

**Kuhnke FIO Safety SDI16** 694 431 00

Safe input module  
 Safety protocol: FSoE  
 Safety standard: IEC 61508 SIL3 and DIN EN ISO 13849-1 Cat. 4 / PL e  
 Number of inputs: 16 safe inputs (configurable properties)  
 Extended diagnostic information: Via CoE



## 8.5.2 Accessories

#### Technical Data

**KUHNKE FIO Safety PLC** 694 330 00

Safety control unit  
 Safety protocol: FSoE  
 Safety standard: IEC 61508 SIL3 and DIN EN ISO 13849-1 Cat. 3 / PL e  
 Approvals: CE, cULus (planned), TÜV Rheinland  
 Runtime system: CODESYS RT Safety  
 Programming tool: CODESYS v3.5 SP5 or higher with integrated safety function modules



## 8.5.3 Spare Parts

There are no spare parts for the FIO Safety I/O module.

You are not allowed to repair Kuhnke's FIO Safety I/O module. Please return the defective module to Kendrion Kuhnke Automation GmbH in Malente → 9 Sales & Service.



## 9 Sales & Service

Please visit our Internet site to find a comprehensive overview of our sales and service network including all the relevant addresses. Feel free to also contact us at our headquarters in Malente/Germany:

### **KENDRION**

The screenshot shows the Kendrion website homepage. At the top, there is a navigation menu with links for 'Products', 'Applications', 'Development competences', 'About us', 'News', 'Careers', and 'Contact'. Below the menu is a large header image of the Kendrion Kuhnke Automotive GmbH building in Malente, Germany. A 'TOP 100 Top-Innovator 2017' award sign is visible in the foreground of the header image. The main content area is a grid of six product categories, each with an image and a red call-to-action button:

- HMI Line**: Image of HMI panels. Button: 'To the panel PLCs ▶'
- I/O Line**: Image of I/O modules. Button: 'To the I/O systems ▶'
- Controller Line**: Image of a controller module. Button: 'To the control systems ▶'
- Software Line\***: Image of a laptop displaying software. Button: 'To the software line ▶'
- Industrial Heater Line**: Image of a heater module. Button: 'To the power heat controllers ▶'
- CODESYS starter kits**: Image of starter kit components. Button: 'To the starter kits ▶'

### 9.1.1 Malente Headquarters

Kendrion Kuhnke Automation GmbH  
 Industrial Control Systems  
 Lütjenburger Straße 101  
 D-23714 Malente, Germany

Tel. +49 4523 402-0

Fax +49 4523 402-201

Email: [sales-ics@kendrion.com](mailto:sales-ics@kendrion.com)

Web: [www.kuhnke.kendrion.com](http://www.kuhnke.kendrion.com)